



TAI-SAW TECHNOLOGY CO., LTD.

No. 3, Industrial 2nd Rd., Ping-Chen Industrial District,
Tao-Yuan, 324, Taiwan, R.O.C.

TEL: 886-3-4690038 FAX: 886-3-4697532

E-mail: tstsales@mail.taisaw.com Web: www.taisaw.com

Approval Sheet for Product Specification

Issued Date:

Product Name: 350MHz IF SAW Filter (BW=14 MHz)

TST Parts No.: TB0674A

Customer Parts No.: _____

Company: _____
Division: _____
Approved by : _____
Date: _____

Checked by: _____ Andy Yu

Approval by: _____ Francis Chen

Date: _____ 6/5/2008



TAI-SAW TECHNOLOGY CO., LTD.

No.3, Industrial 2nd Rd., Ping-Chen Industrial District, Taoyuan, Taiwan, R.O.C.

TEL: 886-3-4690038 FAX: 886-3-4697532

E-mail: tstsales3@mail.taisaw.com Web: www.taisaw.com

SAW Filter 350MHz (SMD 5.0×7.0 mm)

MODEL NO.: TB0674A

Rev. NO. 1

A. MAXIMUM RATINGS:

1. Input Power Level: 10 dBm
2. Operating Temperature: -40 °C ~ 85°C
3. Storage Temperature: -40°C to 85°C

RoHS Compliant
Lead free
Lead-free soldering

B. ELECTRICAL CHARACTERISTICS:

1. Ambient Temperature: 25 °C

Characteristics		Value		
		Min.		Max.
Center frequency	F_C MHz	-	350.0	-
Maximum Insertion loss	I.L. dB	-	10.5	12.0
1dB Bandwidth	MHz	14	16.2	-
3dB Bandwidth	MHz	-	18.2	-
35dB Bandwidth	MHz	-	35.3	38.0
Passband Ripple in $F_C \pm 7.0$ MHz	dB	-	0.6	1.0
S11 Return Loss $F_C \pm 7.0$ MHz	dB	-	8	-
Temp Coefficient	ppm/°C		-18	
Attenuation:(Reference level from minimum insertion loss)				
1)	240 ~ 315 MHz dB	40	56	-
2)	385 ~ 450 MHz dB	40	56	-

C. Frequency Characteristics :

1. S21 Response:(span 100MHz)

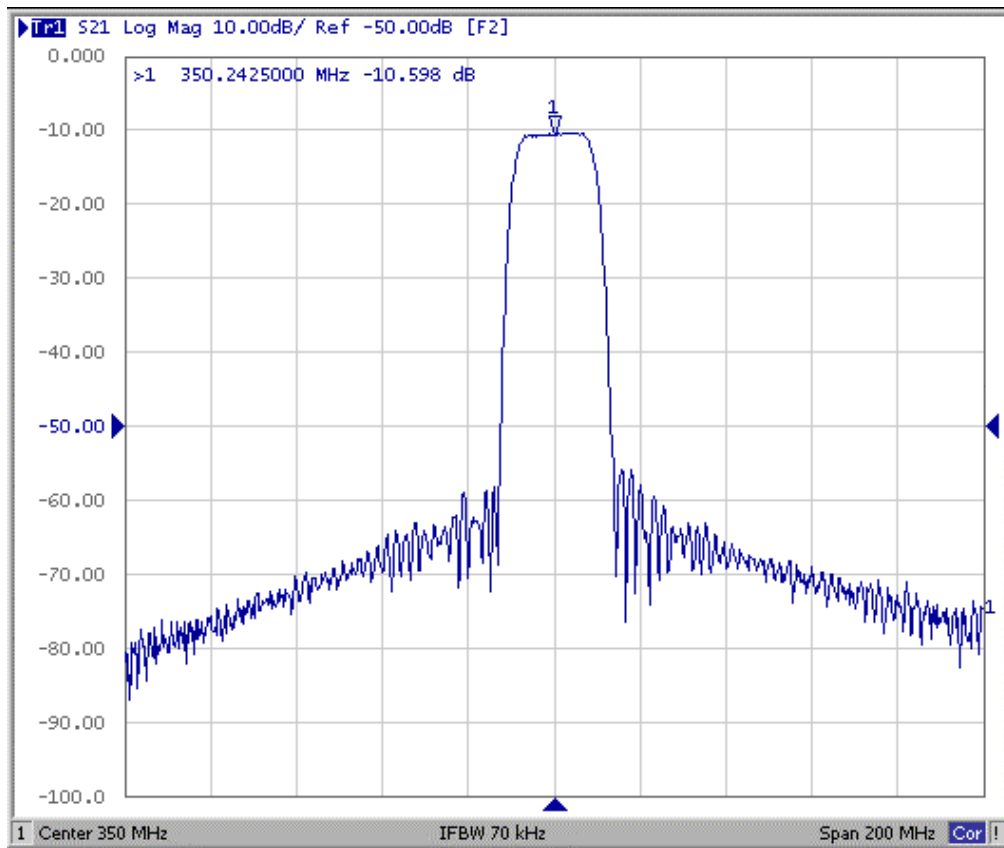

2. Passband Response: (span 25MHz)

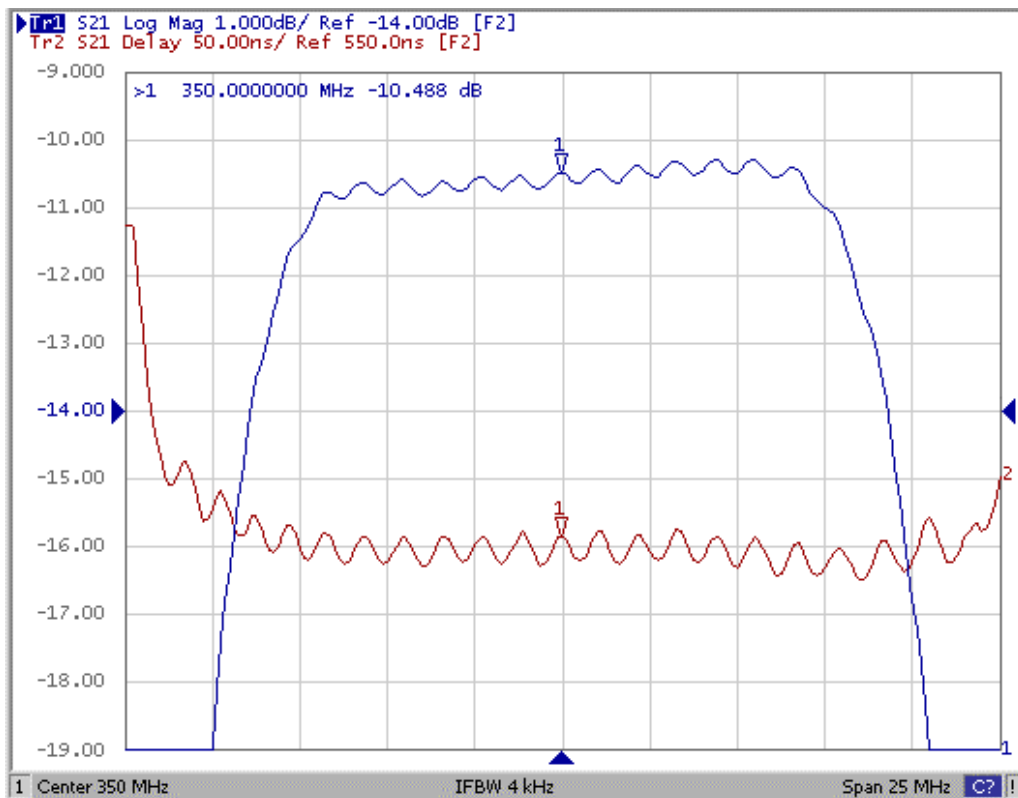

3. S11 Smith-Chart: (span 100MHz)

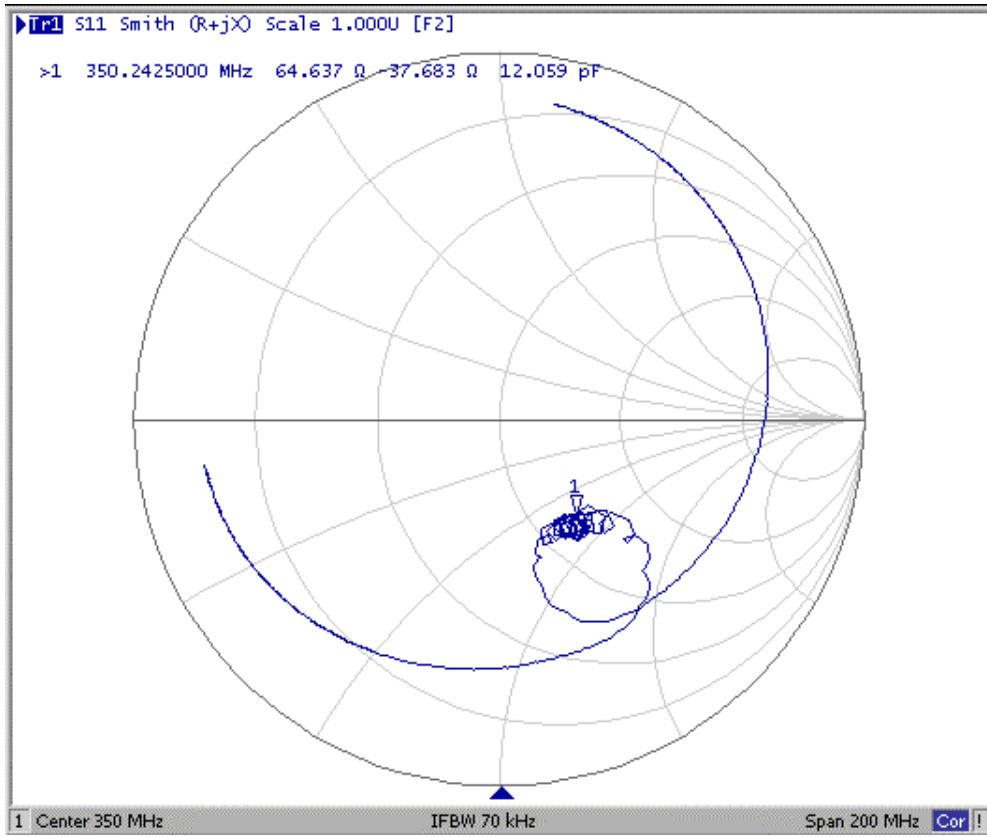

4. S22 Smith-Chart: (span 100MHz)

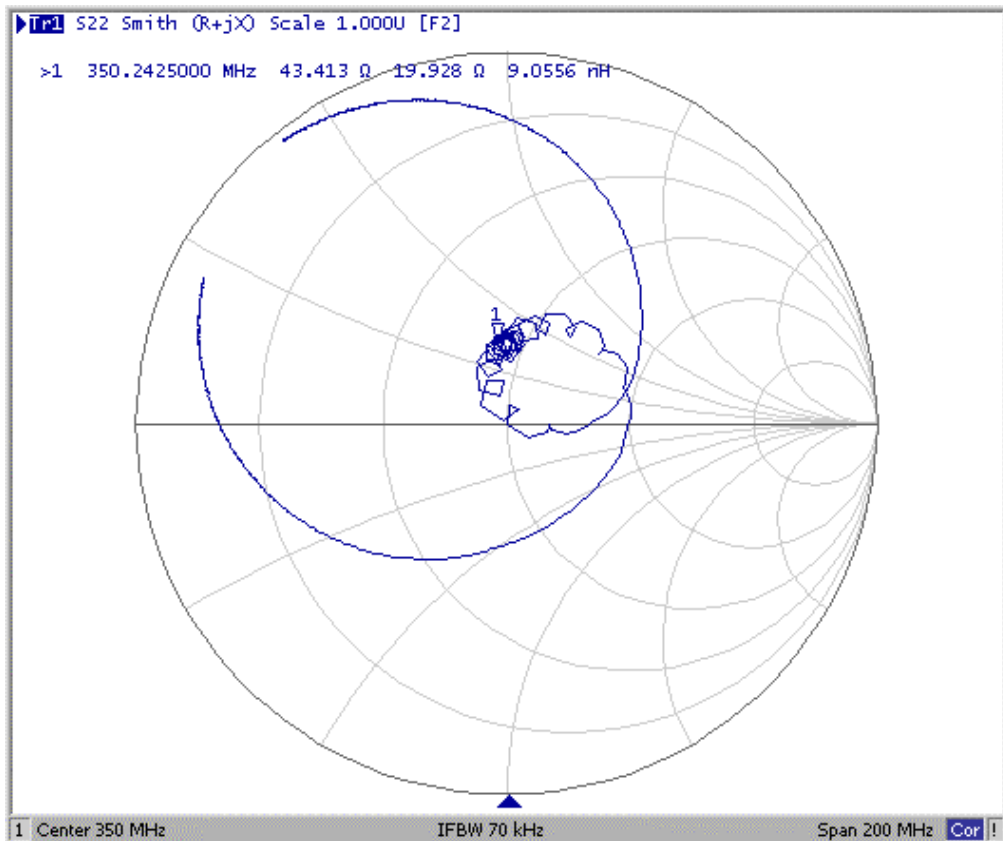

D. TEST CIRCUIT:

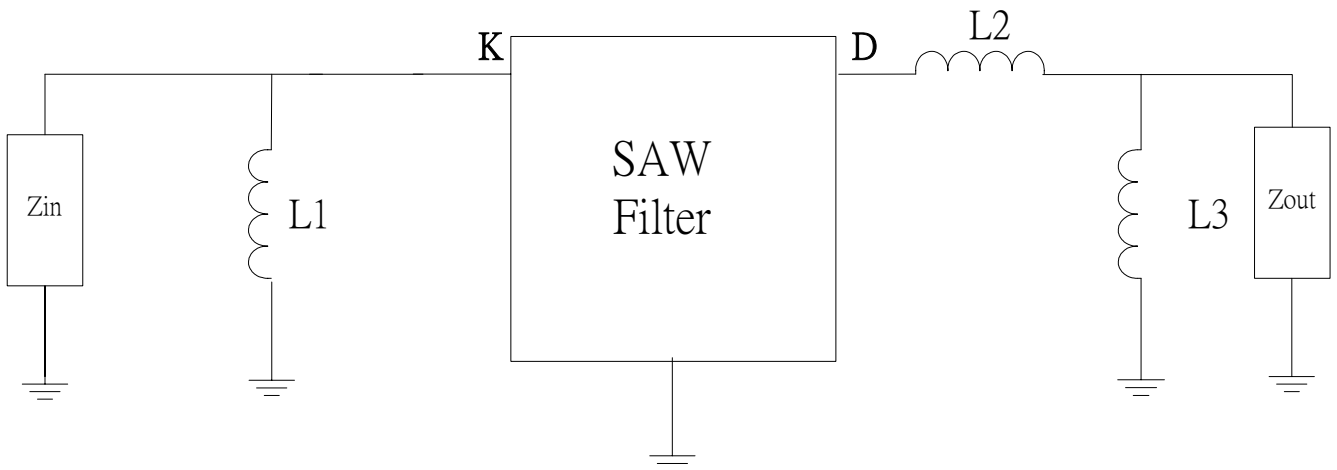

$Z_{in} = Z_{out} = 50 \text{ ohm}$

$L1=15\text{nH}, L2=10\text{nH}, L3=8.2\text{nH}$

E. OUTLINE DRAWING:

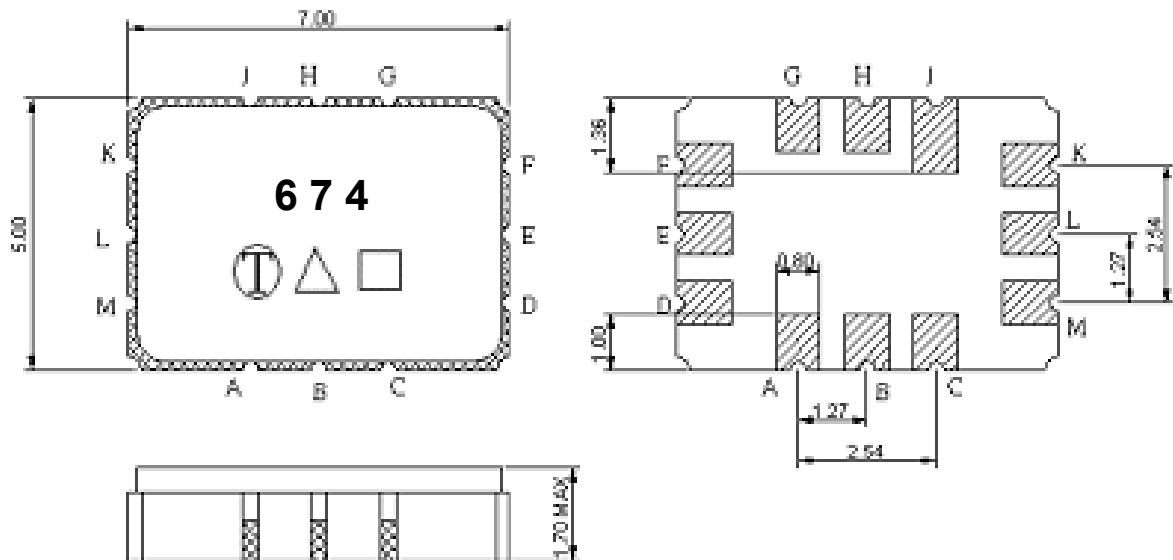

Pin K: RF input

Pin D: RF output

Pin L, M, A, B, C, E, F, G, H, I: Ground

□ : Week Code (Follow the table from planner each year)

Unit : mm

△ : Product / Year Code

Year	2005 2009	2006 2010	2007 2011	2008 2012
Product Code	B	b	<u>B</u>	<u>b</u>

F.PACKING:

1.REEL DIMENSION

(Reel Count: 7"=1000 typ.; 13"=2000 typ.)

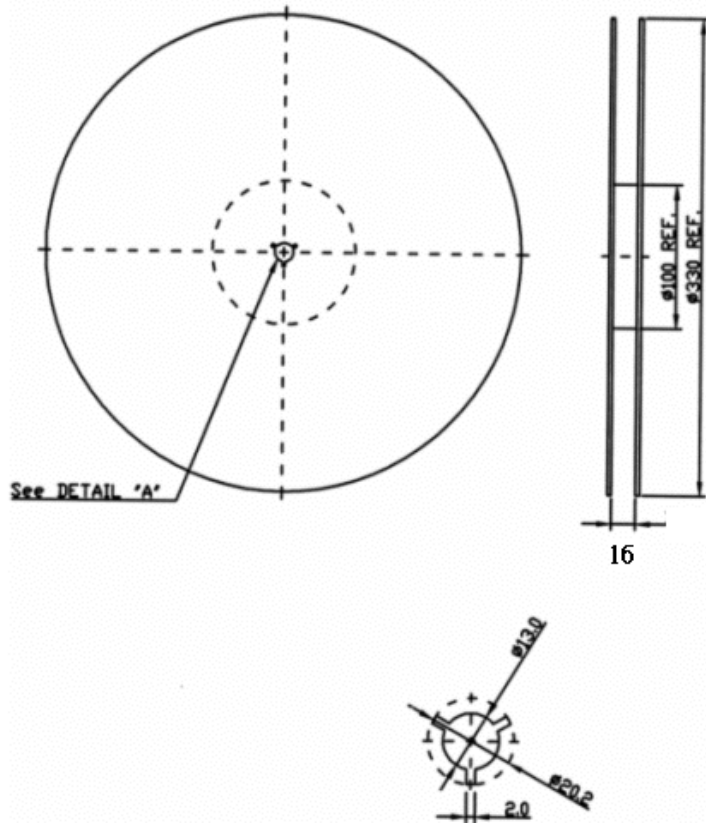

2.TAPE DIMENSION

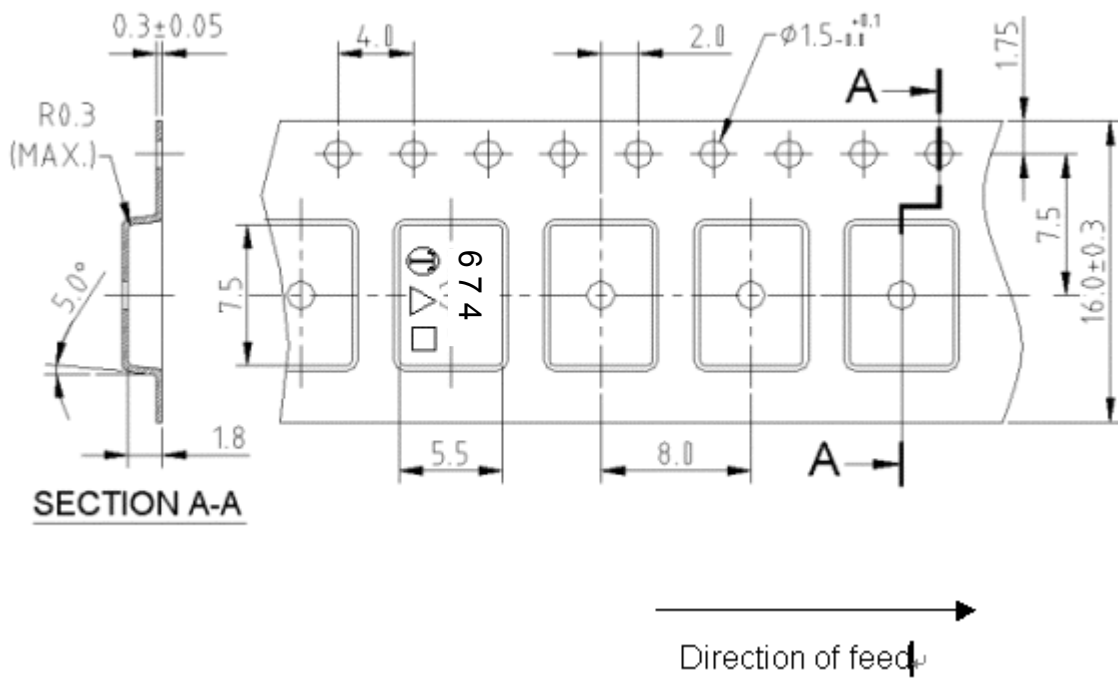

G. Recommended Reflow Profile:

