



Shanghai Lunsure Electronic
Technology Co.,Ltd
Tel:0086-21-37185008
Fax:0086-21-57152769

MUR105GP THRU MUR160GP

Features

- High Surge Capability
- Low Forward Voltage Drop
- High Current Capability
- Super Fast Switching Speed For High Efficiency

Maximum Ratings

- Operating Temperature: -65°C to +150°C
- Storage Temperature: -65°C to +150°C

Part Number	Maximum Recurrent Peak Reverse Voltage	Maximum RMS Voltage	Maximum DC Blocking Voltage
MUR105GP	50V	35V	50V
MUR110GP	100V	70V	100V
MUR115GP	150V	105V	150V
MUR120GP	200V	140V	200V
MUR140GP	400V	280V	400V
MUR160GP	600V	420V	600V

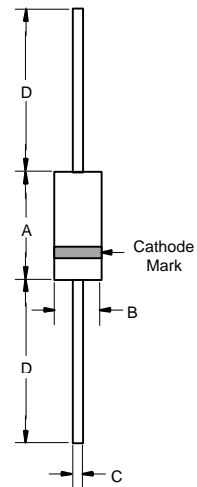
Electrical Characteristics @ 25°C Unless Otherwise Specified

Average Forward Current	$I_{F(AV)}$	1.0A	$T_A = 55^\circ\text{C}$
Peak Forward Surge Current	I_{FSM}	25A	8.3ms, half sine
Maximum Instantaneous Forward Voltage MUR105GP-115GP MUR120GP-160GP	V_F	.97V 1.35V	$I_{FM} = 1.0A$; $T_A = 25^\circ\text{C}$
Maximum DC Reverse Current At Rated DC Blocking Voltage	I_R	5.0 μ A 50 μ A	$T_A = 25^\circ\text{C}$ $T_A = 150^\circ\text{C}$
Maximum Reverse Recovery Time MUR105GP-140GP MUR160GP	T_{rr}	45ns 60ns	$I_F=0.5A$, $I_R=1.0A$, $I_{rr}=0.25A$
Typical Junction Capacitance MUR105GP-115GP MUR120GP-160GP	C_J	15pF 10pF	Measured at 1.0MHz, $V_R=4.0V$

*Pulse Test: Pulse Width 300 μ sec, Duty Cycle 1%

1.0 Amp Glass Passivated Super Fast Recovery Rectifier 50 to 600 Volts

DO-41

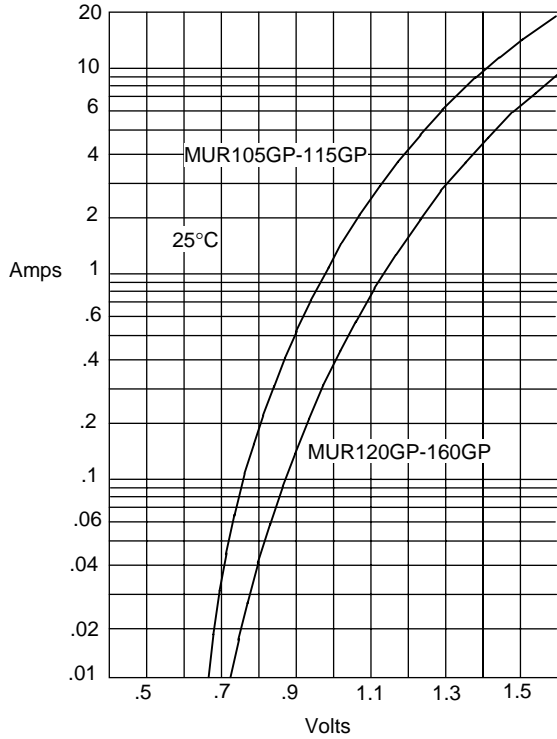


DIM	DIMENSIONS				NOTE
	INCHES		MM		
A	MIN .166	MAX .205	MIN 4.10	MAX 5.20	
B	MIN .080	MAX .107	MIN 2.00	MAX 2.70	
C	MIN .028	MAX .034	MIN .70	MAX .90	
D	MIN 1.000	MAX ---	MIN 25.40	MAX ---	

MUR105GP thru MUR160GP

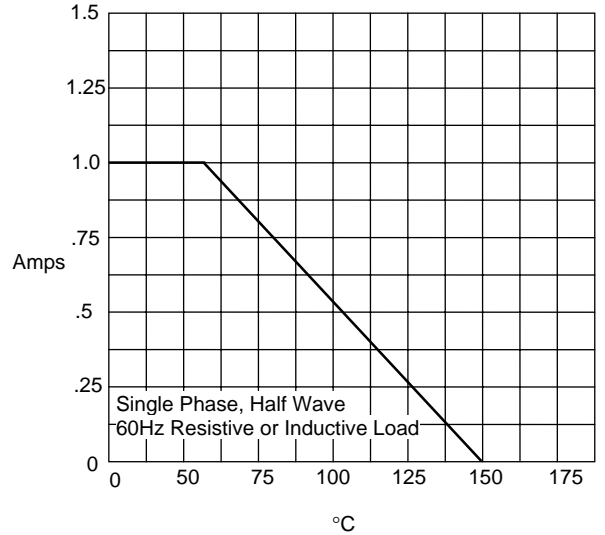


Figure 1
Typical Forward Characteristics



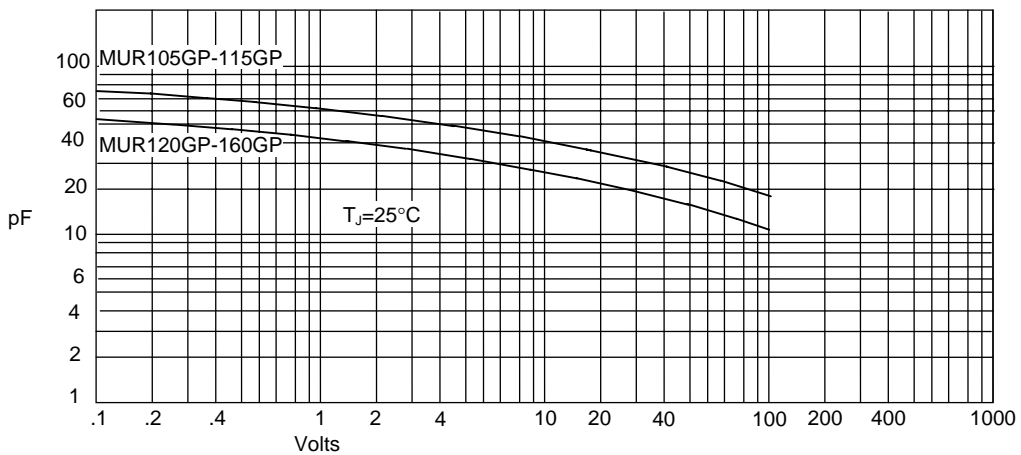
Instantaneous Forward Current - Amperes versus
Instantaneous Forward Voltage - Volts

Figure 2
Forward Derating Curve



Average Forward Rectified Current - Amperes versus
Ambient Temperature - °C

Figure 3
Junction Capacitance

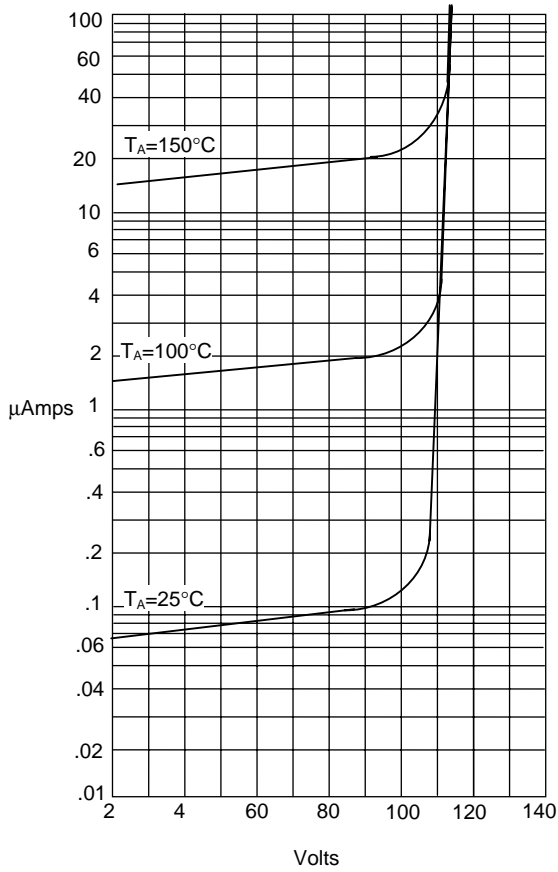


Junction Capacitance - pF versus
Reverse Voltage - Volts

MUR105GP thru MUR160GP

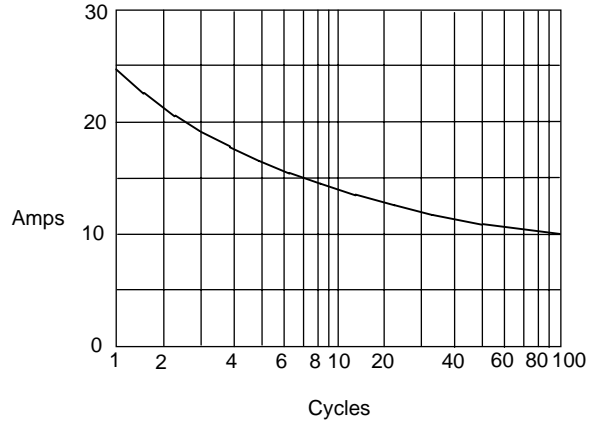


Figure 4
Typical Reverse Characteristics



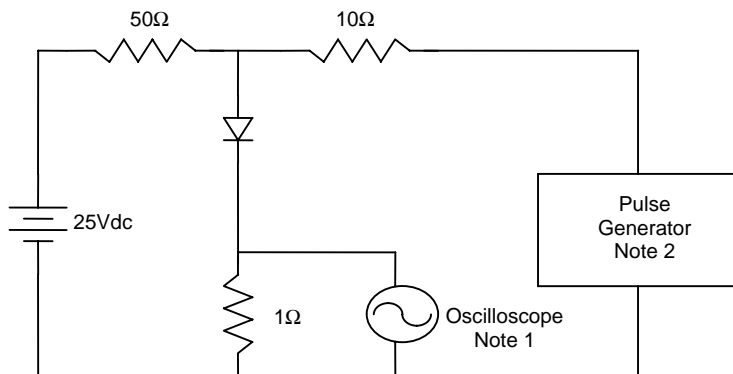
Instantaneous Reverse Leakage Current - MicroAmperes versus
Percent Of Rated Peak Reverse Voltage - Volts

Figure 5
Peak Forward Surge Current



Peak Forward Surge Current - Amperes versus
Number Of Cycles At 60Hz - Cycles

Figure 6
Reverse Recovery Time Characteristic And Test Circuit Diagram



- Notes:
1. Rise Time = 7ns max.
Input impedance = 1 megohm, 22pF
 2. Rise Time = 10ns max.
Source impedance = 50 ohms
 3. Resistors are non-inductive

