

RT1P436X SERIES

Transistor

Transistor With Resistor

For Switching Application

Silicon PNP Epitaxial Type

DESCRIPTION

RT1P436X is a one chip transistor with built-in bias resistor, NPN type is RT1N436X.

FEATURE

- Built-in bias resistor (R1=4.7k, R2=47k).

APPLICATION

Inverted circuit, switching circuit, interface circuit, driver circuit.

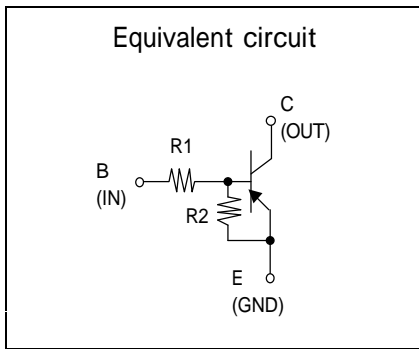

OUTLINE DRAWING

UNIT: mm

RT1P436U

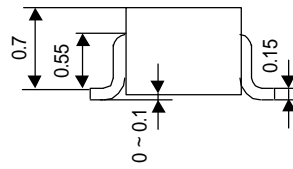
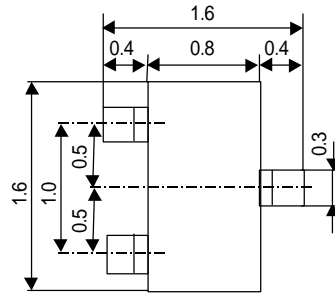

JEITA: -
JEDEC: -

Terminal Connector
: Base
: Emitter
: Collector

RT1P436C

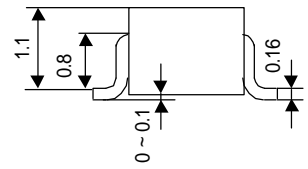
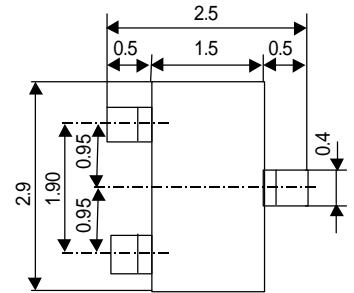

JEITA: SC-59
JEDEC: Similar to TO-236

Terminal Connector
: Base
: Emitter
: Collector

RT1P436M

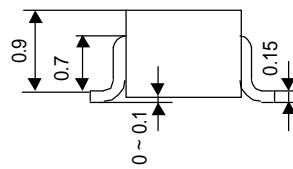
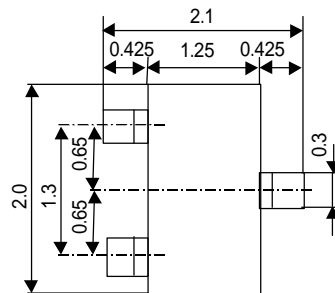

JEITA: SC-70
JEDEC: -

Terminal Connector
: Base
: Emitter
: Collector

RT1P436S

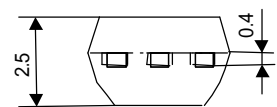
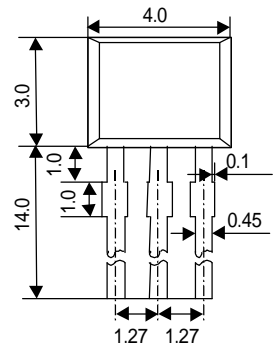

JEITA: -
JEDEC: -

Terminal Connector
: Emitter
: Collector
: Base

RT1P436X SERIES

Transistor

Transistor With Resistor

For Switching Application

Silicon PNP Epitaxial Type

MAXIMUM RATING (Ta=25 °C)

SYMBOL	PARAMETER	RATING				UNIT
		RT1P436U	RT1P436M	RT1P436C	RT1P436S	
V_{CBO}	Collector to Base voltage			-50		V
V_{EBO}	Emitter to Base voltage			-6		V
V_{CEO}	Collector to Emitter voltage			-50		V
I_C	Collector current			-100		mA
I_{CM}	Peak Collector current			-200		mA
P_C	Collector dissipation(Ta=25 °C)	150	200	450		mW
T_j	Junction temperature	+150	+150			
T_{stg}	Storage temperature	-55 ~ +150	-55 ~ +150			

ELECTRICAL CHARACTERISTICS (Ta=25 °C)

SYMBOL	PARAMETER	TEST CONDITION	LIMIT			UNIT
			MIN	TYP	MAX	
$V_{(BR)CEO}$	C to E break down voltage	$I_C = -100 \mu A, R_{BE} =$	-50			V
I_{CBO}	Collector cut off current	$V_{CB} = -50V, I_E = 0$			-0.1	μA
h_{FE}	DC forward current gain	$V_{CE} = -5V, I_C = -10mA$	80			-
$V_{CE(sat)}$	C to E saturation voltage	$I_C = -10mA, I_B = -0.5mA$		-0.1	-0.3	V
$V_{I(ON)}$	Input on voltage	$V_{CE} = -0.2V, I_C = -5mA$		-0.8	-1.4	V
$V_{I(OFF)}$	Input off voltage	$V_{CE} = -5V, I_C = -100 \mu A$	-0.4	-0.6		V
R_1	Input resistance		3.3	4.7	6.1	k
R_2 / R_1	Resistance ratio		8	10	12	
f_T	Gain band width product	$V_{CE} = -6V, I_E = 10mA$		150		MHz

TYPICAL CHARACTERISTICS

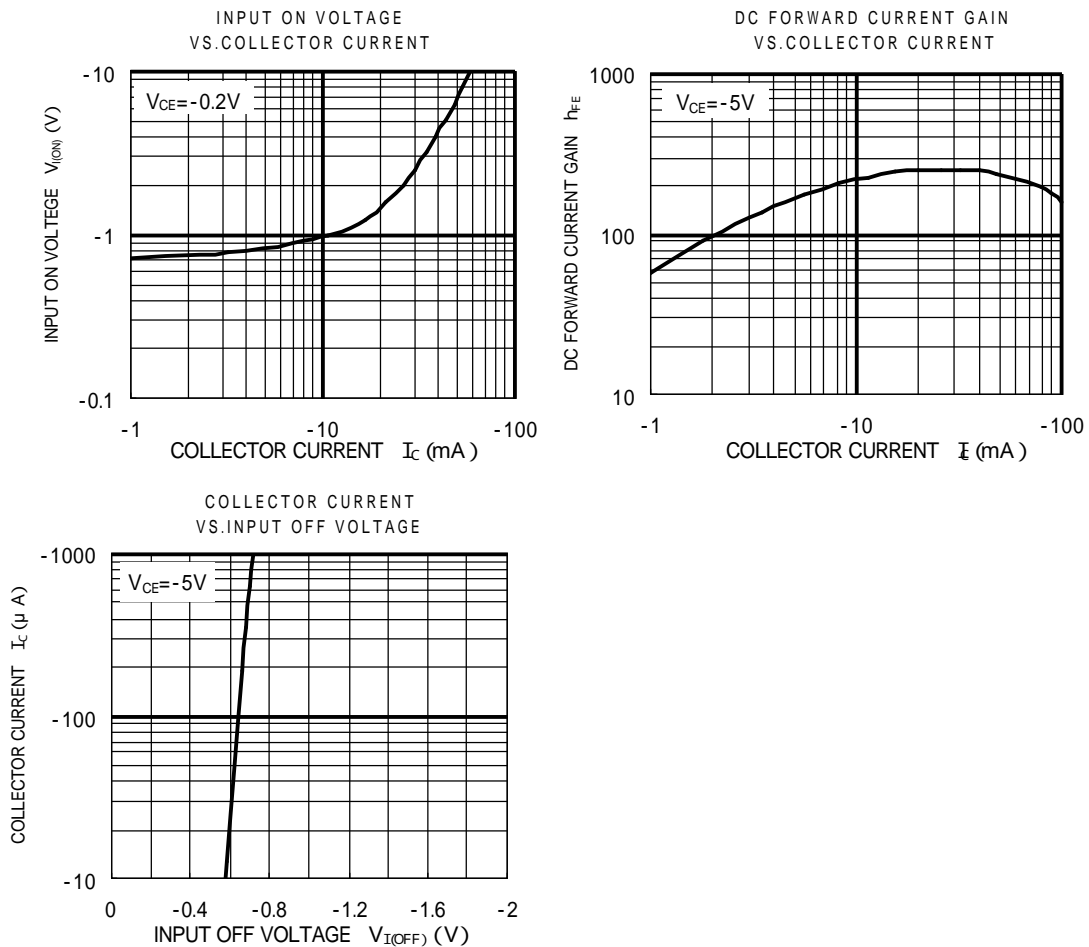



Marketing division, Marketing planning department

6-41 Tsukuba, Isahaya, Nagasaki, 854-0065 Japan

Keep safety first in your circuit designs!

•ISAHAYA Electronics Corporation puts the maximum effort into making semiconductor products better and more reliable, but there is always the possibility that trouble may occur with them. Trouble with semiconductors may lead to personal injury, fire or property damage. Remember to give due consideration to safety when making your circuit designs, with appropriate measures such as (1) placement of substitutive, auxiliary, (2) use of non-flammable material or (3) prevention against any malfunction or mishap.

Notes regarding these materials

- These materials are intended as a reference to our customers in the selection of the ISAHAYA products best suited to the customer's application; they don't convey any license under any intellectual property rights, or any other rights, belonging ISAHAYA or third party.
- ISAHAYA Electronics Corporation assumes no responsibility for any damage, or infringement of any third party's rights, originating in the use of any product data, diagrams, charts or circuit application examples contained in these materials.
- All information contained in these materials, including product data, diagrams and charts, represent information on products at the time of publication of these materials, and are subject to change by ISAHAYA Electronics Corporation without notice due to product improvements or other reasons. It is therefore recommended that customers contact ISAHAYA Electronics Corporation or an authorized ISAHAYA products distributor for the latest product information before purchasing product listed herein.
- ISAHAYA Electronics Corporation products are not designed or manufactured for use in a device or system that is used under circumstances in which human life is potentially at stake. Please contact ISAHAYA electronics corporation or an authorized ISAHAYA products distributor when considering the use of a product contained herein for any specific purposes, such as apparatus or systems for transportation, vehicular, medical, aerospace, nuclear, or undersea repeater use.
- The prior written approval of ISAHAYA Electronics Corporation is necessary to reprint or reproduce in whole or in part these materials.
- If these products or technologies are subject to the Japanese export control restrictions, they must be exported under a license from the Japanese government and cannot be imported into a country other than the approved destination. Any diversion or re-export contrary to the export control laws and regulations of Japan and/or the country of destination is prohibited.
- Please contact ISAHAYA Electronics Corporation or authorized ISAHAYA products distributor for further details on these materials or the products contained therein.