

### Specifications

Parameter	Unit	Minimum	Typical	Maximum
Center Frequency	MHz	69.95	70	70.05
Insertion Loss	dB		19	21
3 dB Bandwidth	MHz	1.75	1.8	1.85
Selectivity	$F0 \pm 1.3\text{MHz}$	dBc	35	42
	$F0 \pm 1.5\text{MHz}$	dBc	45	52
	$F0 \pm 1.9\text{MHz}$	dBc	50	61
	$F0 \pm 5.9\text{MHz}$	dBc	55	63
Absolute Delay	usec		3.876	4
Ultimate Rejection( $f0 \pm 15\text{MHz}$ )	dBc	55	60	
Passband Variation	dB		0.7	1
Substrate Material			Quartz	
Ambient Temperature	°C		25	
Package Size		DIP3512 (35.0x12.8x4.7mm <sup>3</sup> )		

#### Notes:

1. All specifications are based on the test circuit shown
2. In production, devices will be tested at room temperature to a guardbanded specification to ensure electrical compliance over temperature
3. Electrical margin has been built into the design to account for the variations due to temperature drift and manufacturing tolerances
4. This is the optimum impedance in order to achieve the performance show

### Matching Configuration

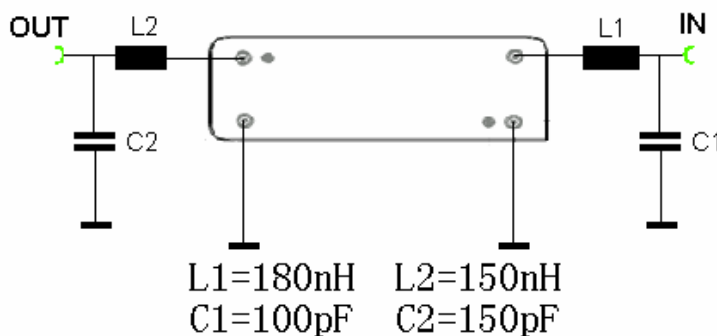

**Source/Load Impedance=50 ohm**

Notes - Component values may change depending on board layout.

	<b>SIPAT Co., Ltd.</b> ( CETC No. 26 Research Institute ) Nanping Huayuan Road No. 14 Chongqing, China, 400060	Part Number	SP LBS07086	
		Rev. Date	2004-12-1	
		Rev.	1.0	Page

*Package Dimension*

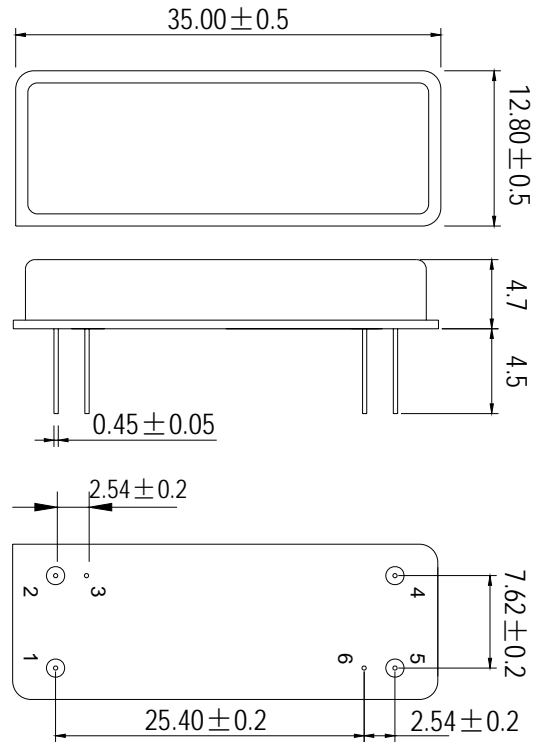

**input:1**  
**Output:5**



**SIPAT Co., Ltd.**  
( CETC No. 26 Research Institute )  
Nanping Huayuan Road No. 14  
Chongqing, China, 400060

Part Number	SP LBS07086	
Rev. Date	2004-12-1	
Rev.	1.0	Page 2/3

Typical Performance

Frequency Response

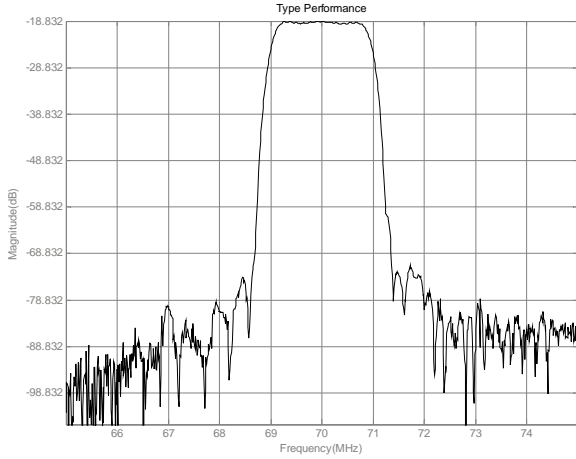

Passband Response

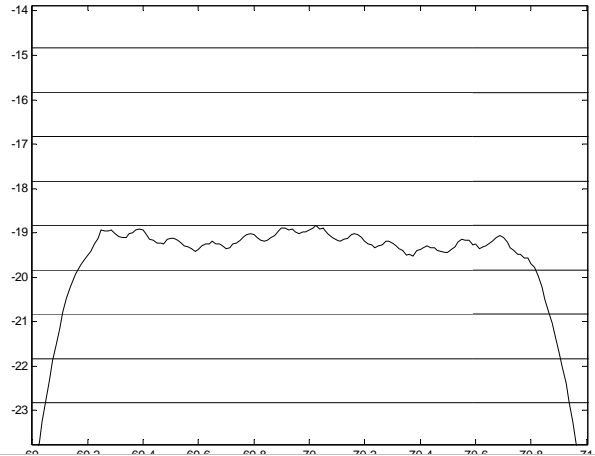

Wideband Response

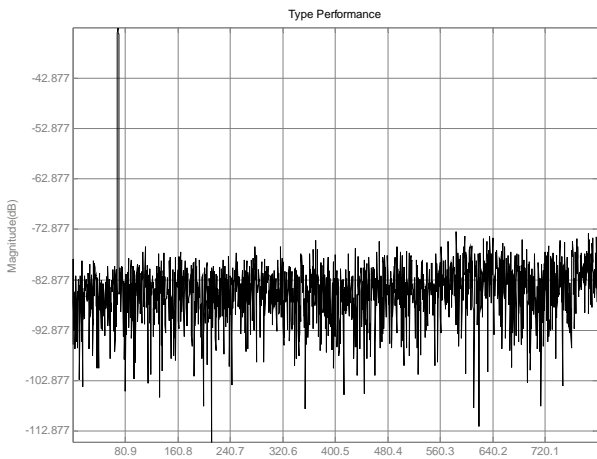

3dB Phase Linearity

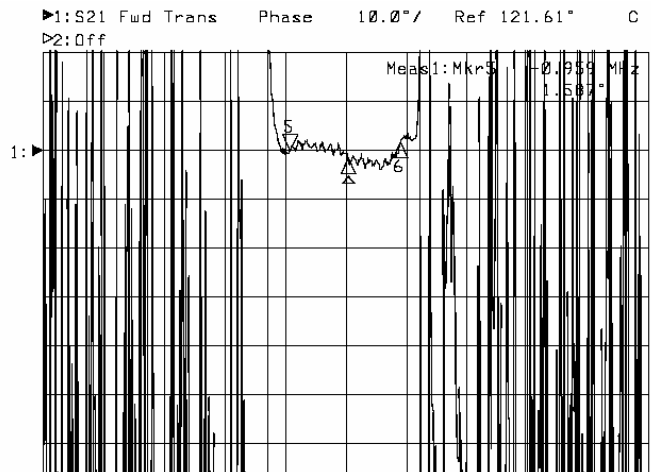

Smith Chart S11

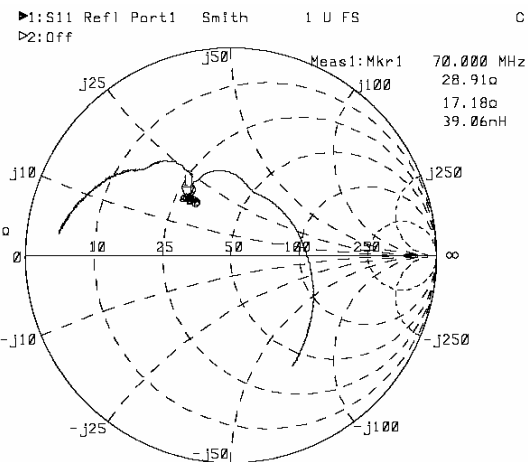

Smith Chart S22

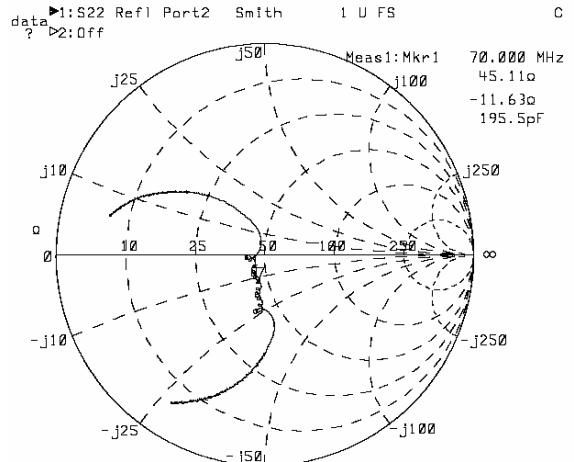

**SIPAT Co., Ltd.**  
( CETC No. 26 Research Institute )  
Nanning Huayuan Road No. 14  
Chongqing, China, 400060

Part Number

SP LBS07086

Rev. Date

2004-12-1

Rev.

1.0

Page 3/3