M54133FP/GP

Earth Leakage Current Detector

REJ03F0029-0100Z

Rev.1.0

Sep.16.2003

Description

The M54133FP/GP is a semiconductor integrated circuit developed for use in high-speed earth leakage breakers incorporating functions to protect against voltage surges and inverter noise.

Features

- Lightning surge protection
 - Two-count method adopted
 - Improved dead-time performance for lightning impulses
- Inverter support
 - For active/low-pass filter use
 - Internal op-amp (low current consumption)
 - Improved high-frequency, high harmonic superposition performance
- Internal time delay function
 - A time delay function can be configured
- High input sensitivity
 - $V_T=11.5 \text{ mV}_{\text{rms}}$
- Low current consumption
 - Standby: 610 μA (typical)
 - Leakage detection: 650 μA (typical)
- High-stability design
 - Adopts a circuit with minimal characteristic fluctuation when changes occur in the power supply voltage or ambient temperature

Applications

- Earth leakage breaker

Recommended Operating Conditions

- Operating power supply voltage range: 7 to 12 V
- Operating ambient temperature: -20 to 85°C

Block Diagram

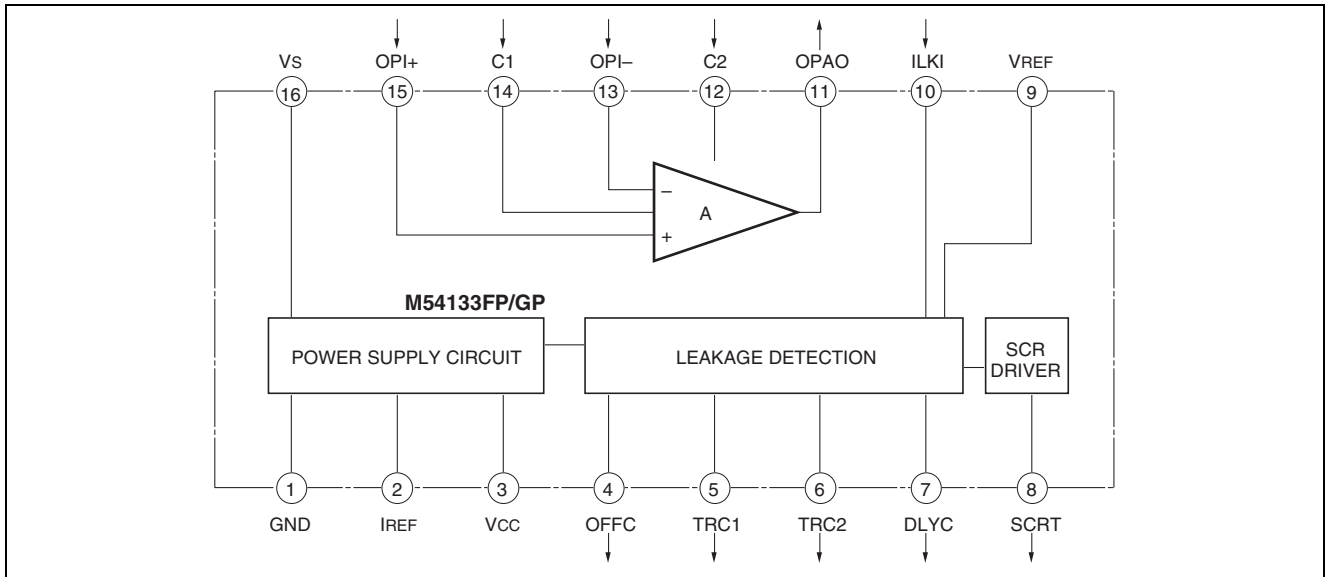

Pin Configuration

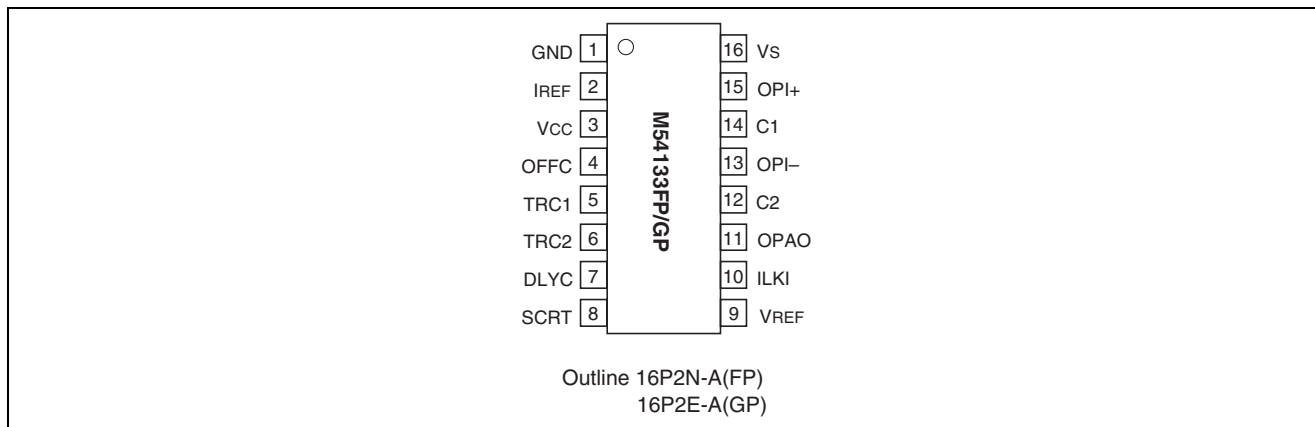

Pin Description

Pin no.	Name	Function
16	VS	Power supply
• Common		
3	VCC	Output pin for internal constant-voltage circuit; connected to decoupling capacitor
2	IREF	Pin for connection to resistor to set constant current for internal circuits; approx. 1.3 V
1	GND	Ground
• Op-amp		
13	OPI-	Op-amp input pins
15	OPI+	
14	C1	Pin for connection to capacitors to prevent noise-induced erroneous operation; connected between pins [13], [14] and pins [15], [14]
12	C2	Pin for connection to capacitor to prevent oscillation; connected with pin [11].
11	OPAO	Op-amp output pin
• Leakage detection, SCR driving circuit		
9	VREF	Input reference level pin for leak detection circuit; approx. 2.4 V
10	ILKI	Another input pin for leak detection circuit
5	TRC1	Pin to connect a capacitor used to integrate the level discriminator output signal of the leak input signal
6	TRC2	Pin to connect a capacitor for noise elimination
4	OFFC	When leak input signal is not continued When a leak is detected and SCR is turned on After a prescribed amount of time, this IC is returned to the initial state. A capacitor to set the time for this function is connected.
7	DRYC	Pin to connect a capacitor to set the time when using the time delay function
8	SCRT	Thyristor driving output pin

Absolute Maximum Ratings

(Unless otherwise noted, Ta = 25°C)

Symbol	Parameter	Test conditions	Ratings	Unit
I _S	Power supply current		4	mA
I _{V_{Smax}}	Maximum power supply voltage		15	V
V _{id}	Differential input voltage	Across OPI+ and OPI-	-0.8 to 0.8	V
I _{IOP}	Differential input current	Across OPI+ and OPI-	-5 to 5	mA
I _{IG}	Input current	Across VREF and GND	10	mA
P _d	Power consumption		200	mW
T _{opr}	Operating ambient temperature		-20 to 85	°C
T _{stg}	Storage temperature		-55 to 125	°C

Electrical Characteristics

(Unless otherwise noted, Ta = 25°C)

Sym- bol	Quantity		Measurement conditions		Ratings			Units			
			Vs		Min.	Typ.	Max.				
I _{s0}	Power supply circuit	Power supply current, during standby	9 V		520	610	700	μA			
I _{s1}		Power supply current, during leak detection			560	650	740	μA			
I _{s2}		Power supply current, immediately after SCR driving			480	570	660	μA			
—		I _{s0} ambient temp. storage dependence	9 V	Ta = -20 to 85°C	—	-0.2	—	%/°C			
V _{Smax.}		Voltage at max. current	—	I _S = 4 mA	—	13.9	15	V			
V _{CC}		VCC pin output voltage	9 V	I _{OH} = -1 mA	—	5.2	—	V			
G _V	Op-amp	Voltage amplification	9 V	f = 1 kHz	—	40	—	dB			
B _W		Frequency band			—	6	—	kHz			
V _O		Maximum output voltage			—	3.5	—	V _{pp}			
I _{SOURCE}		OPAO pin "H" output current			—	2.8	—	mA			
I _{SINK}		OPAO pin "L" output current			—	0.8	—	mA			
V _{OF}		Output offset voltage			—	0	—	mV			
I _{IB}		Input bias current			—	125	—	nA			
V _{IB}		Differential input clamping voltage			—	I _{ldc} = ±4 mA		—	±0.8	—	V
V _{ION}		Leakage detection circuit			Leakage detection DC input voltage	9 V	vs. VREF	—	±14	—	mVdc
I _{IH}	ILK1 pin input bias current		V _{IN} = VREF	—	220		—	nA			
V _{REF}	VREF pin output voltage		I _{OH} = -200 μA	—	2.4		—	V			
V _{CL}	VREF-GND clamping voltage		I _{RCL} = 5 mA	—	4.7		—	V			
E _{IOH1}	3 ms circuit	TRC1 pin "H" output current precision	9 V	V _O = 0; I _{OH} = -7.6 μA	-10	—	10	%			
V _{TH1}		TRC1 pin threshold voltage			—	2.4	—	V			
E _{TW1}		Tw1 pulse width precision			C ₁ = 0.01 μF; T _{W1} = 3 ms	-15	—	15	%		
—		Tw1 ambient temperature dependence			Ta = -20 to 85°C	—	0	—	%/°C		
E _{IOH2}	1 ms circuit	TRC2 pin "H" output current precision	9 V	V _O = 0; I _{OH} = -7.6 μA	-10	—	10	%			
V _{TH2}		TRC2 pin threshold voltage			—	2.4	—	V			
E _{TW2}		Tw2 pulse width precision			C ₂ = 0.0047 μF; T _{W2} = 1.5 ms	-15	—	15	%		
—		Tw2 ambient temperature dependence			Ta = -20 to 85°C	—	0	—	%/°C		
E _{IOH3}	Reset circuit	OFFC pin "H" output current precision	9 V	V _O = 0; I _{OH} = -7.6 μA	-10	—	10	%			
V _{TH3}		OFFC threshold voltage			—	2.4	—	V			
E _{TW3}		Reset timer pulse width precision			C ₃ = 0.33 μF; T _{W2} = 75 ms	-30	—	30	%		
E _{IOH4}	Time delay circuit	DLYC pin "H" output current precision	9 V	V _O = 0; I _{OH} = -7.6 μA	-10	—	10	%			
V _{TH4}		DLYC threshold voltage			—	2.4	—	V			
E _{TW4}		Time delay timer pulse width precision			C ₄ = 1.0 μF; T _{W2} = 300 ms	-30	—	30	%		
V _{OLB}	SCR driver circuit	SCRT pin "L" output voltage	9 V	I _{OL} = 200 μA	—	0.1	0.2	V			
I _{OHc}		SCRT pin "H" output current	9 V	V _O = 0.8 V	Ta = -20°C	-100	-160	—	μA		
I _{OHn}					Ta = 25°C	-50	-130	—	μA		
I _{OHh}					Ta = 85°C	-30	-100	—	μA		
V _{soff}		IOH hold power supply voltage	—		—	3.0	4.0	V			
V _T	Over-all trip	Overall leak detection AC voltage	9 V	60 Hz	—	11.5	—	mVrms			
—		VT ambient temperature dependence			Ta = +25 to 80°C	—	-8.0	—	%/°C		
					Ta = +25 to -20°C	—	+2.0	—			

Timing Charts

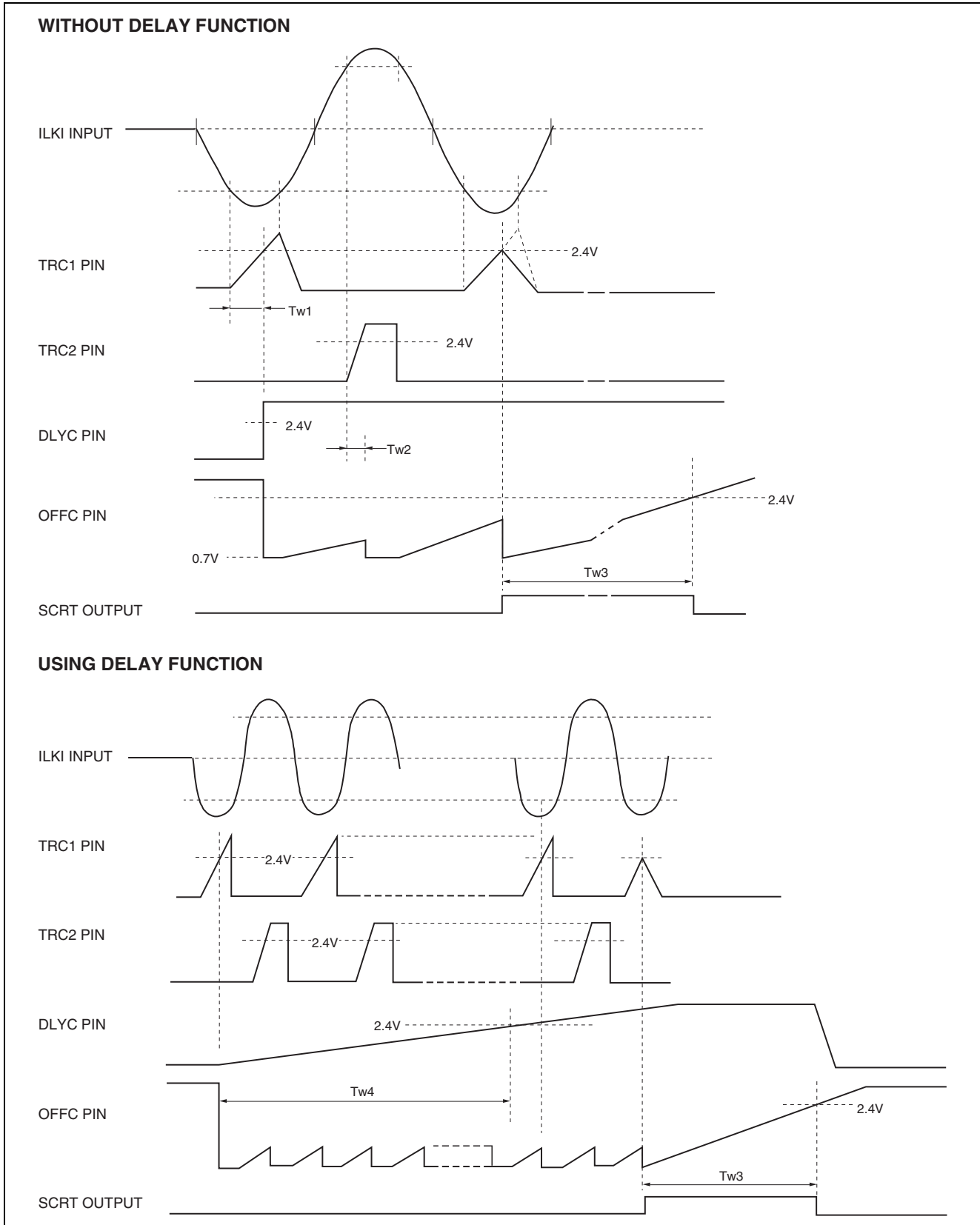

Input/Output Equivalent Circuit

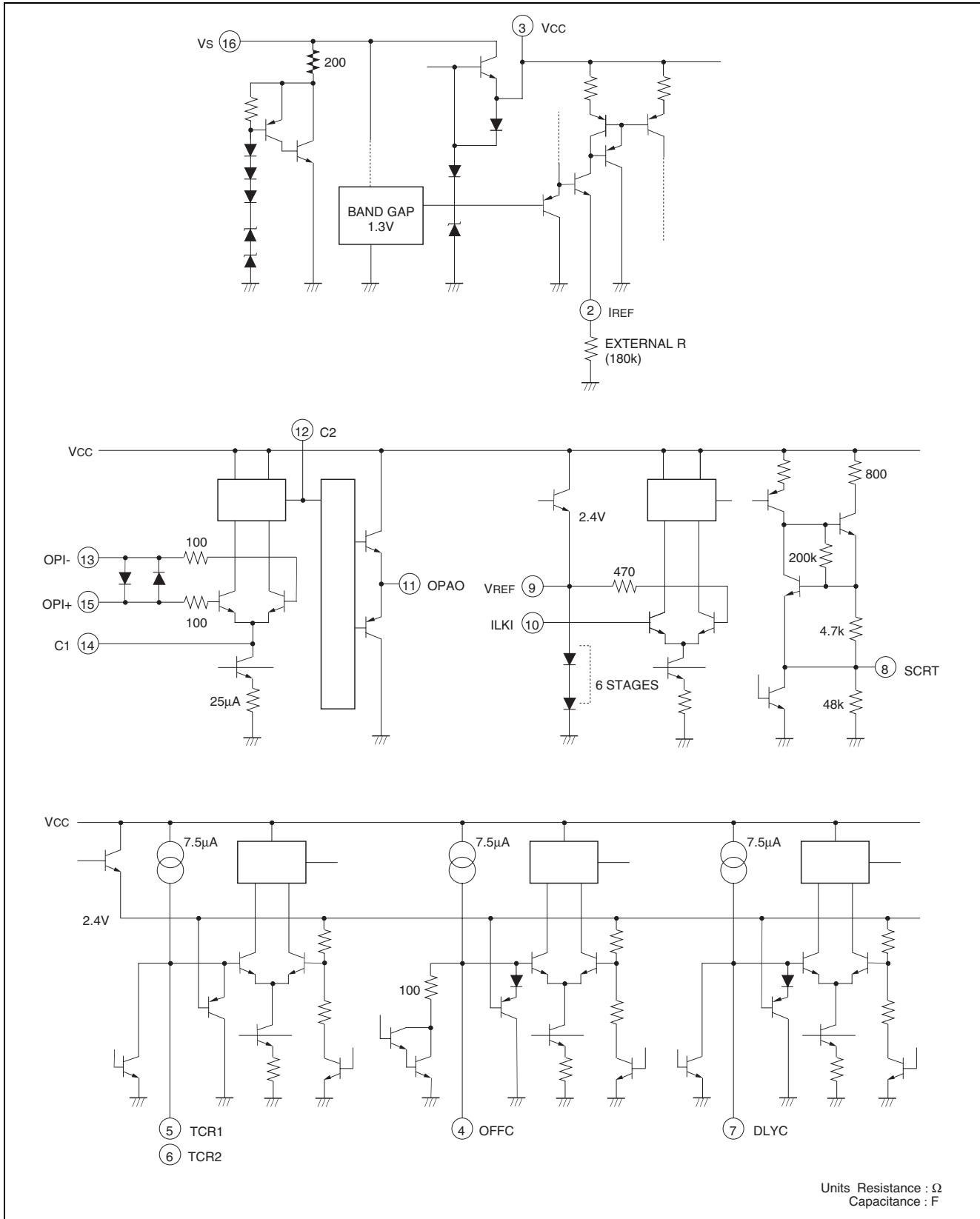

Precaution for Application

Described below are precautions on usage of the M54133FP and the M54133GP. Note that each precaution presents a still better example. It is advisable to review it carefully to learn optimal conditions.

1. Voltage applied to V_s

- (1) Fig.1 shows characteristics of circuit current I_s . (I_s characterizes clamp circuit shown in INPUT/OUTPUT equivalent circuits.) To design power supply, adapt it to IC, considering I_s characteristics.
- (2) Rectification for use of commercial AC line as power source.

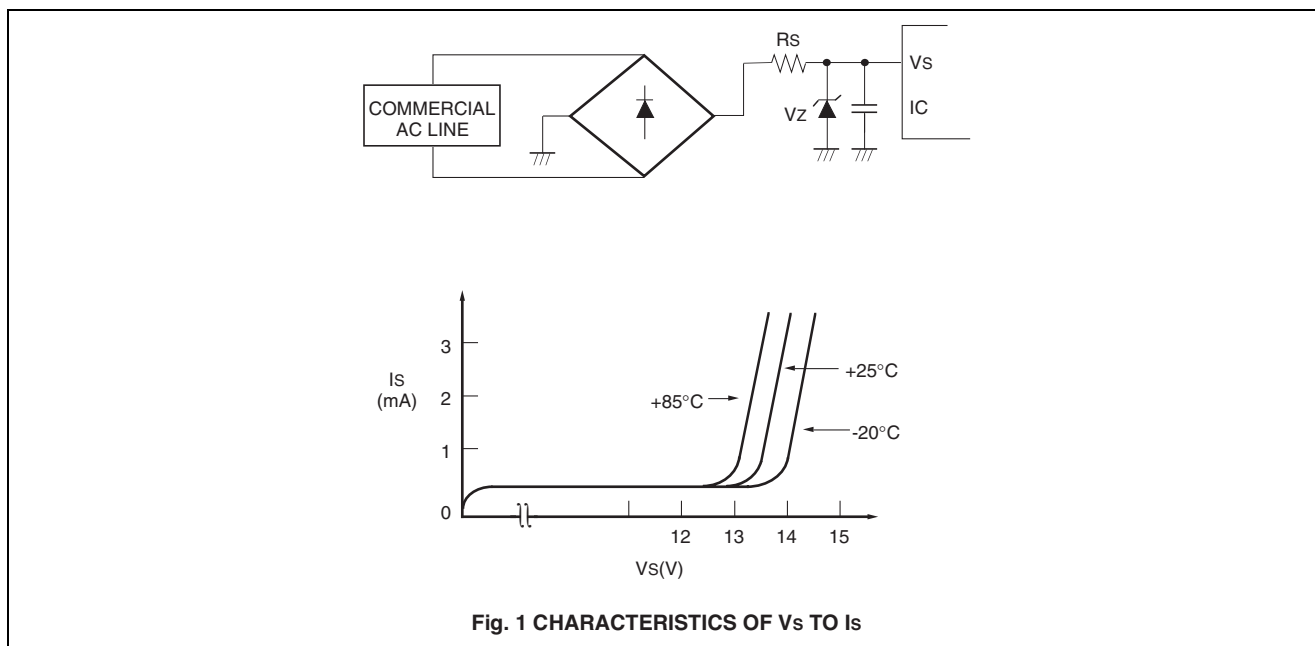

- a) For V_z , select zener diode of 12V or less. (Prevent supply voltage V_s from exceeding absolute maximum rating of 15V.)
 - b) Escalated temperature may decrease supply voltage to produce large current I_s . In this case, R_s limits I_s .
- (3) For use of common DC power supply, set supply voltage V_s within range of 7 to 12V.

2. Resistor ($R = 180k\Omega$) at I_{REF} pin

This resistor provides constant-reference-current source for IC. (Constant current source protects IC against fluctuations in supply voltage and ambient temperature.)

Since every circuit is characterized by resistance of this resistor, the use of high-precision resistor (accuracy of $\pm 2\%$) is recommended.

3. Laying out printed-circuit board

Foreign noise (from noise simulator, for example) may cause malfunctions.

To improve noise resistance, lay out printed-circuit patterns so that wirings of IC to additional capacitors and resistors can be made as short as possible.

Carefully design patterns especially for wiring capacitors to V_s of [16] pin, V_{CC} of [3] pin, and SCRT of [8] pin.

4. Avoid SCRT output pin voltage from falling negative below GND level.

5. Reset time applicable to reset timer circuit

The M54133 has reset timer circuit of $V_L=0.7V$, $V_H=2.4V$, and $I_o=7.5\mu A$. When SCR is on, power supply path is disconnected from leak detector circuit. As shown in illustration below, disconnection may inhibit V_L from falling to $0.7V$. Accordingly, reset time may get shortened. To avoid shortage, predetermine a reset time that includes extra time.

$$T = \frac{C \times (V_H - V_L)}{I_o} = \frac{0.33\mu F \times (2.4 - 0.7)}{7.5\mu A} \approx 75ms$$

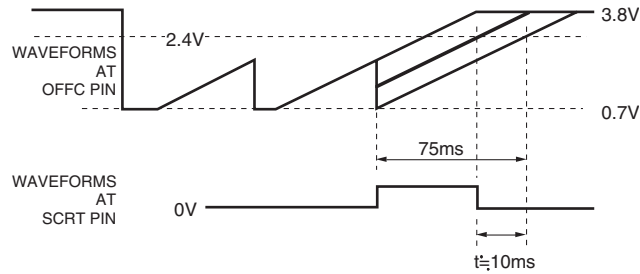

Note. Predetermined reset time may get shortened by t.

Typical Characteristics

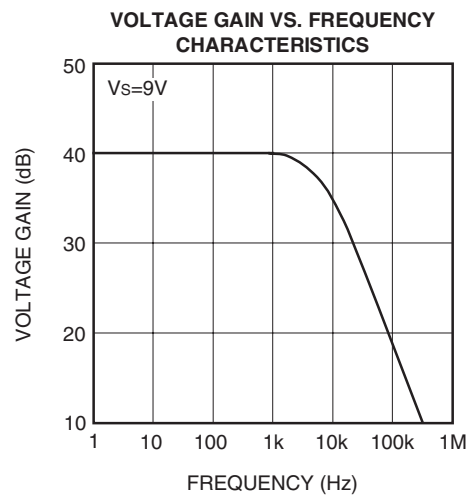
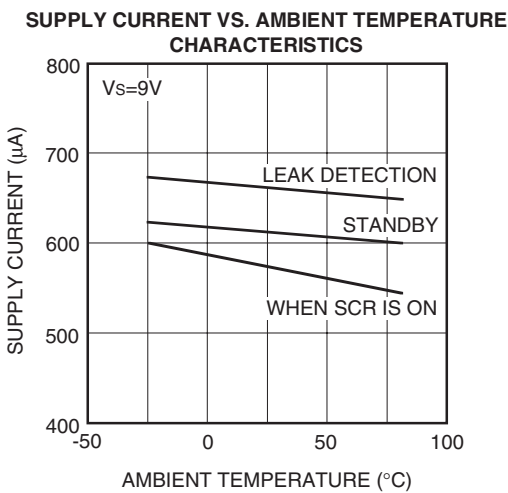
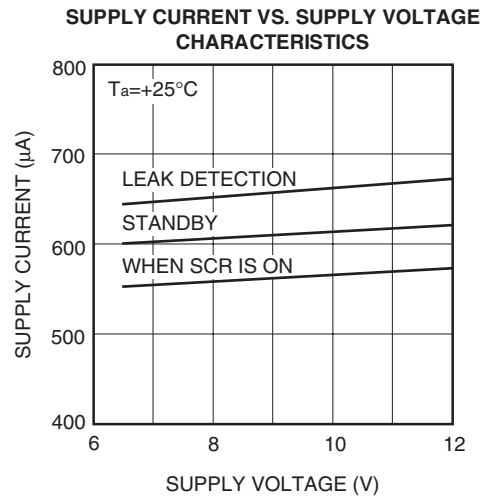
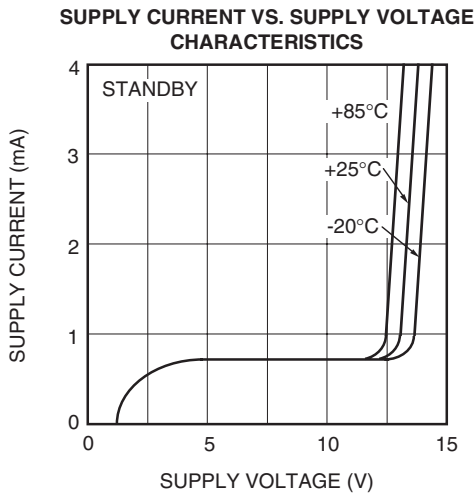
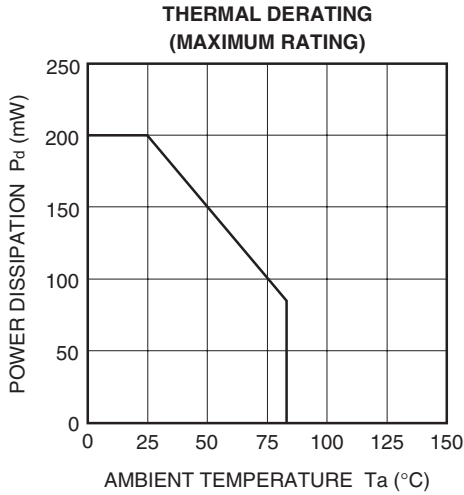

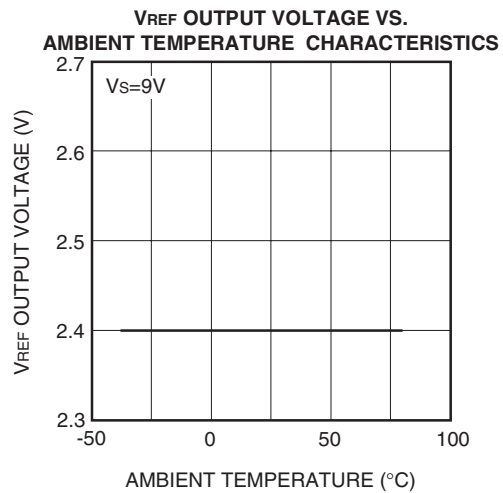
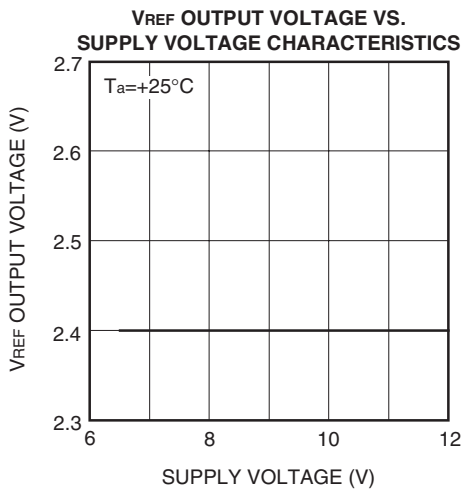
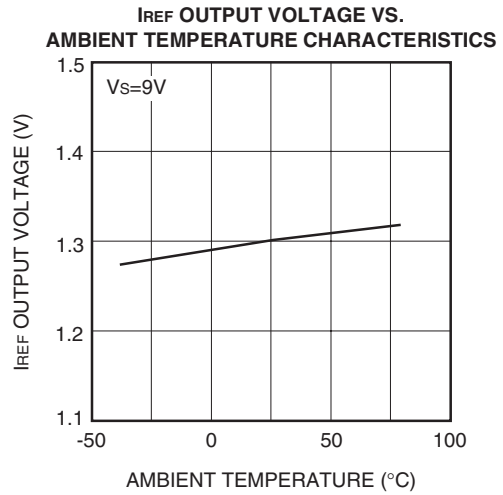
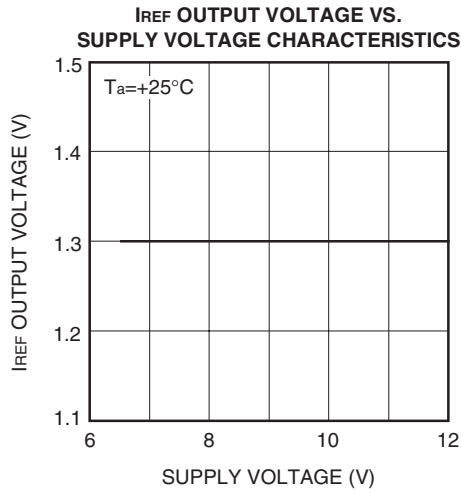
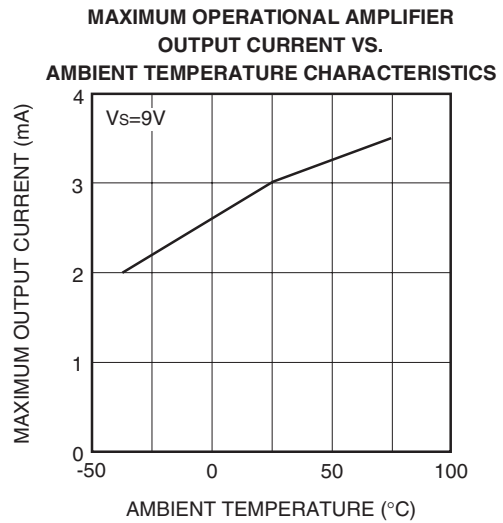
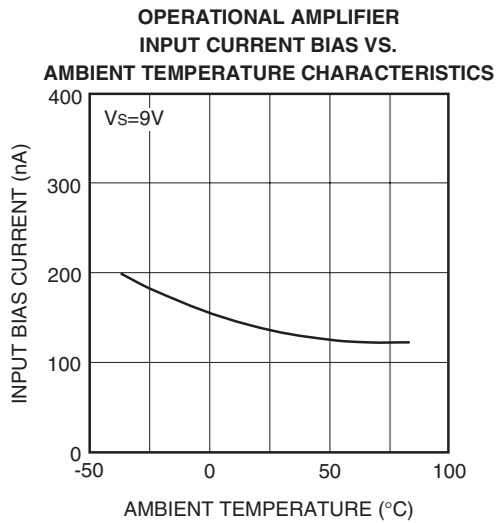

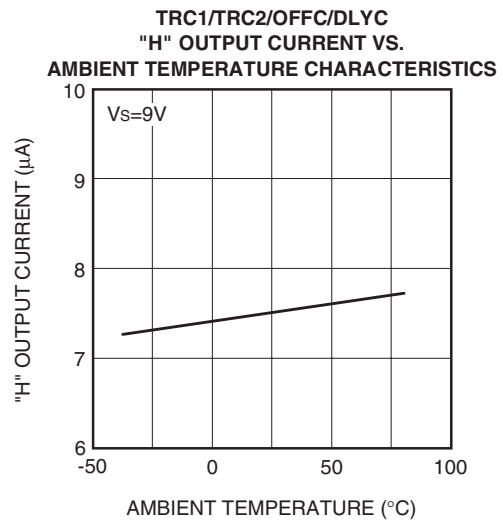
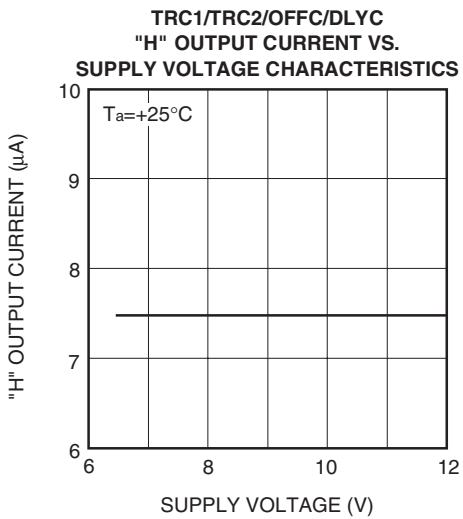
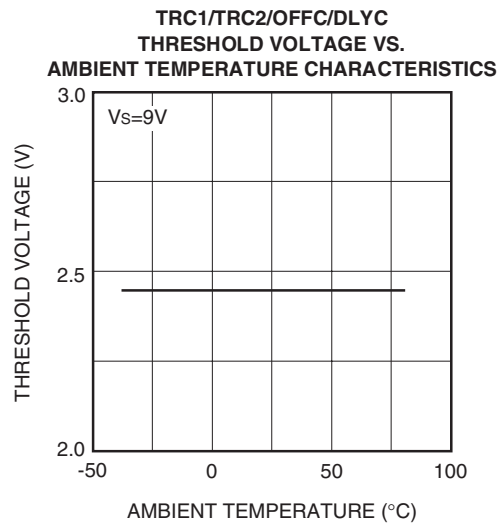
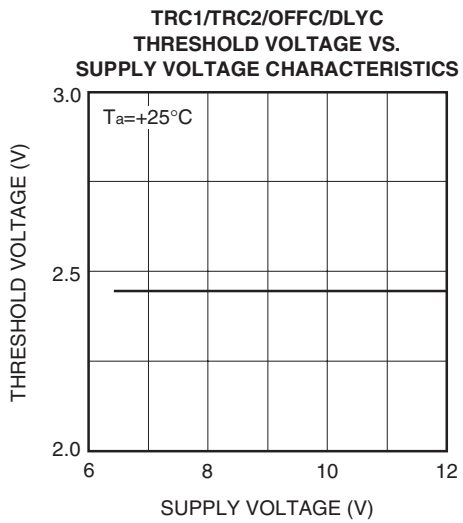
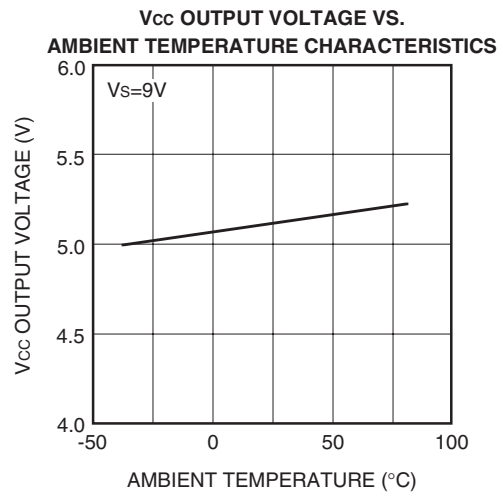
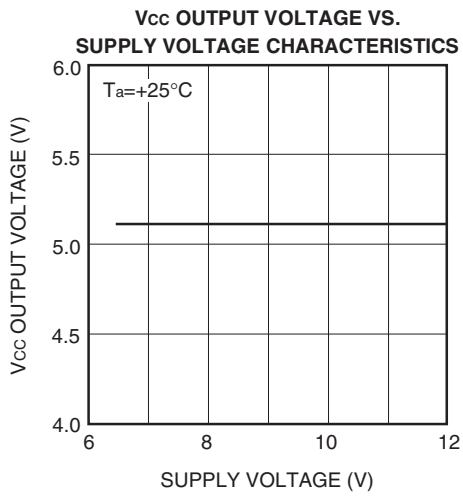

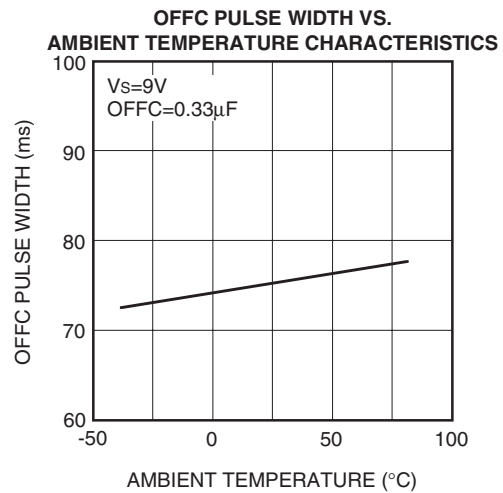
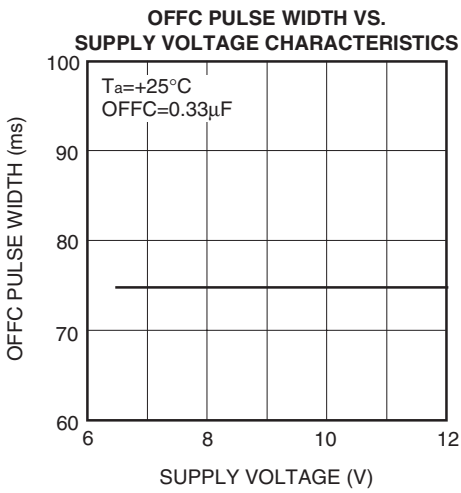
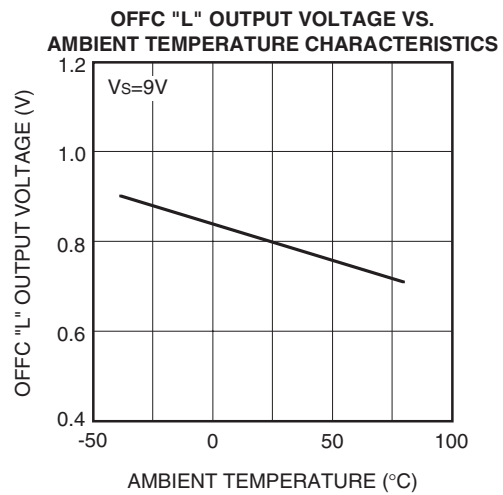
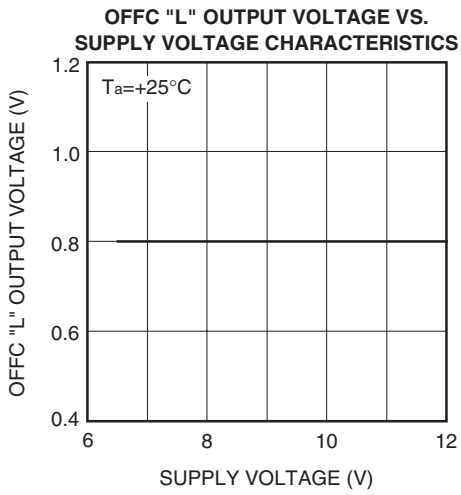
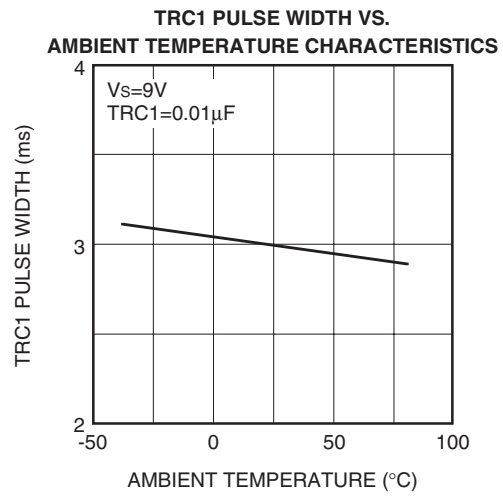
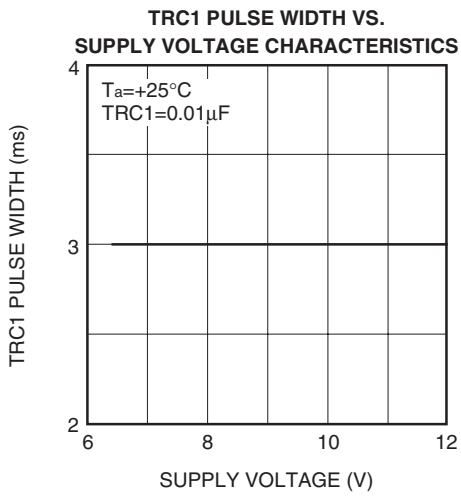

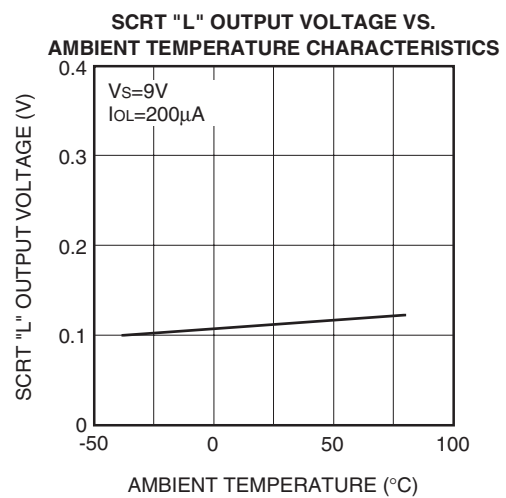
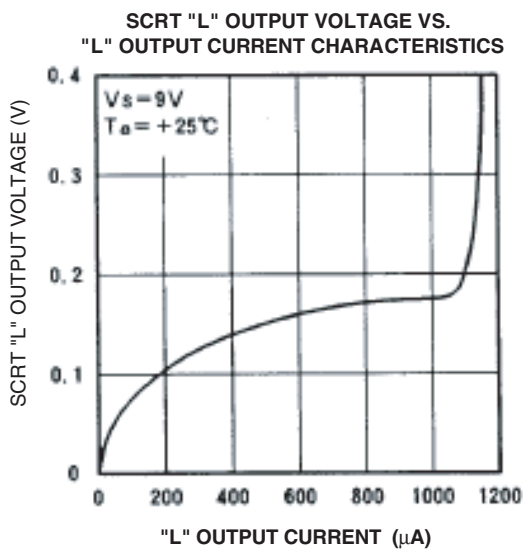
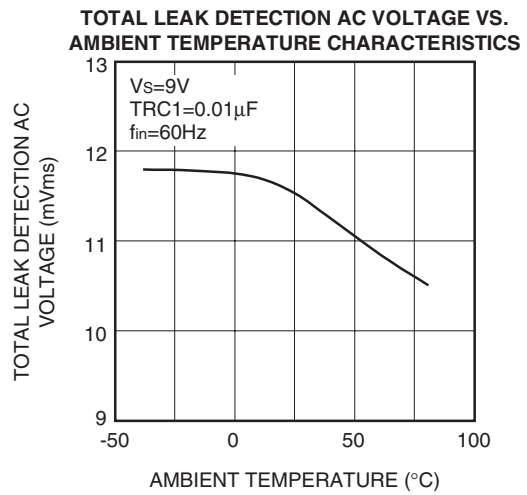
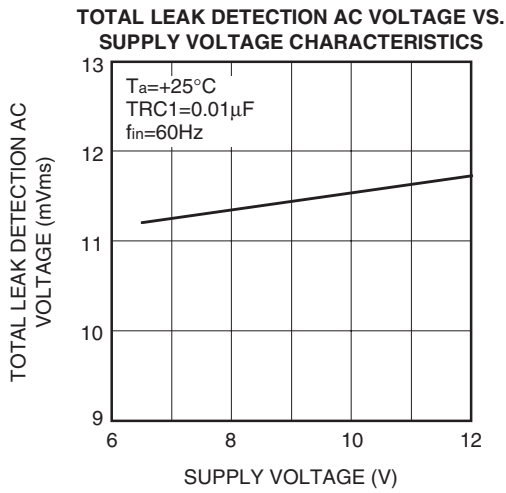
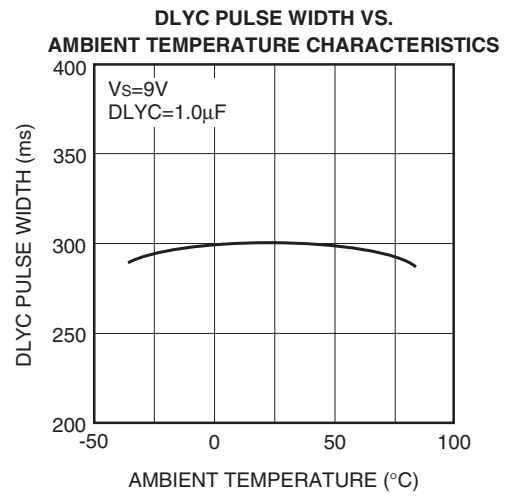
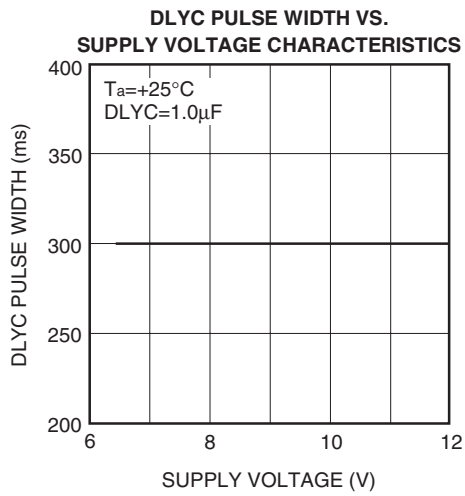

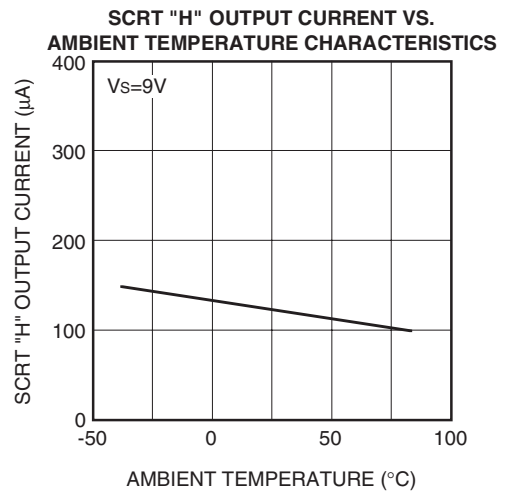
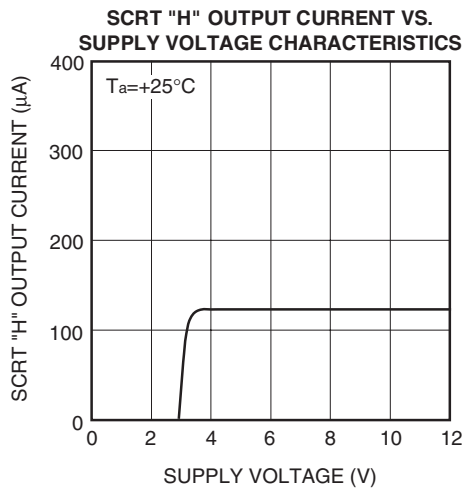

Package Dimensions

16P2N-A

(MMP)

Plastic 16pin 300mil SOP

EIAJ Package Code SOP16-P-300-1.27	JEDEC Code —	Weight(g) 0.2	Lead Material Cu Alloy
---------------------------------------	-----------------	------------------	---------------------------

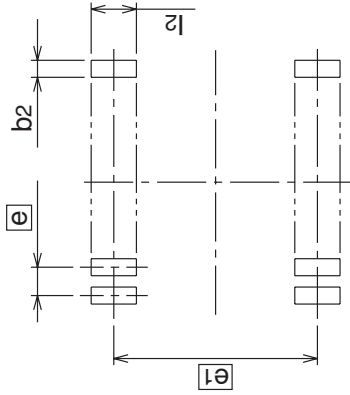
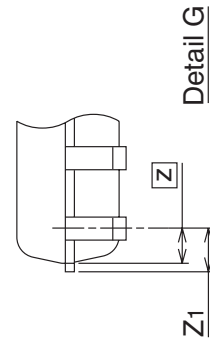
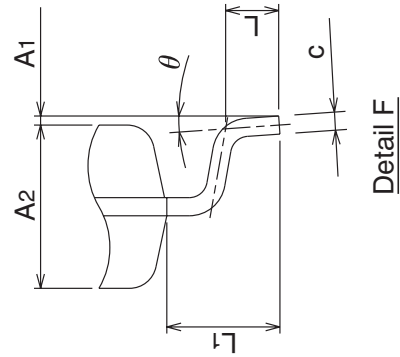
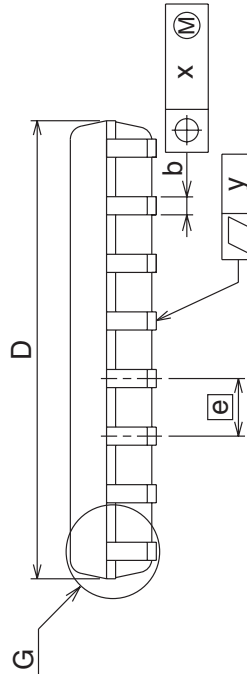
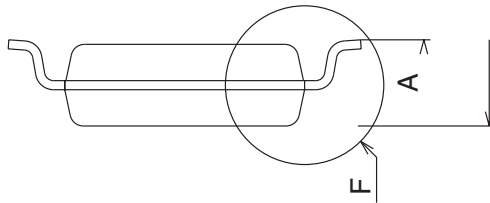
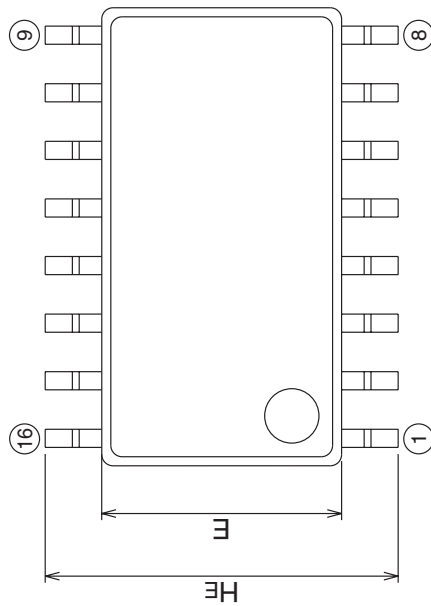

Recommended Mount Pad

Symbol	Dimension in Millimeters		
	Min	Nom	Max
A	—	—	2.1
A1	0	0.1	0.2
A2	—	1.8	—
b	0.35	0.4	0.5
c	0.18	0.2	0.25
D	10.0	10.1	10.2
E	5.2	5.3	5.4
e	—	1.27	—
HE	7.5	7.8	8.1
L	0.4	0.6	0.8
L1	—	1.25	—
Z	—	0.605	—
Z1	—	—	0.755
x	—	—	0.25
y	—	—	0.1
theta	0°	—	8°
b2	—	0.76	—
e1	—	7.62	—
l2	1.27	—	—

16P2E-A

Plastic 16pin 225mil SSOP

EIAJ Package Code SSOP16-P-225-0.65	JEDEC Code —	Weight(g) 0.06	Lead Material Alloy 42
--	-----------------	-------------------	---------------------------

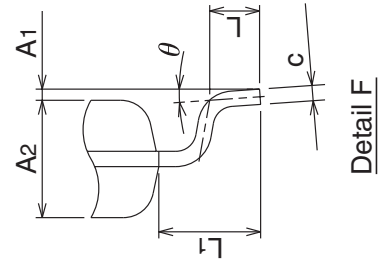
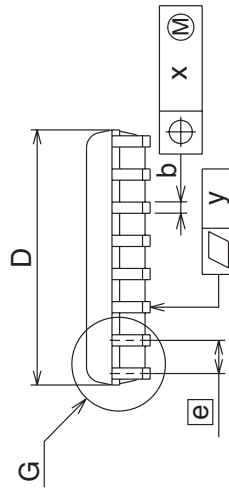
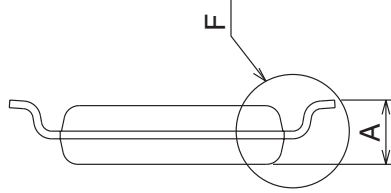
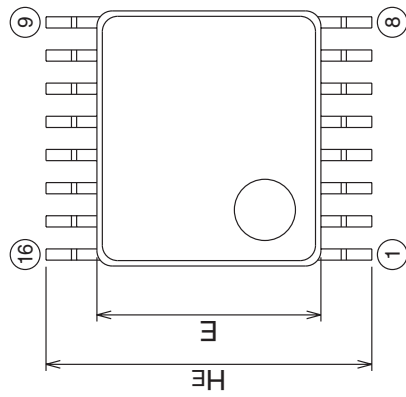

Detail G

Detail F

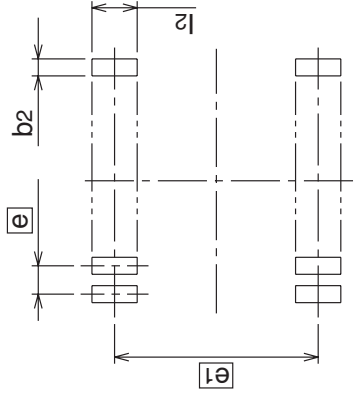

Recommended Mount Pad

Symbol	Dimension in Millimeters		
	Min	Nom	Max
A	—	—	1.45
A1	0	0.1	0.2
A2	—	1.15	—
b	0.17	0.22	0.32
c	0.13	0.15	0.2
D	4.9	5.0	5.1
E	4.3	4.4	4.5
e	—	0.65	—
HE	6.2	6.4	6.6
L	0.3	0.5	0.7
L1	—	1.0	—
z	—	0.225	—
Z1	—	—	0.375
x	—	—	0.13
y	—	—	0.1
theta	0°	—	10°
b2	—	0.35	—
e1	—	5.8	—
l2	1.0	—	—

RENESAS Technology Corp. Sales Strategic Planning Div. Nippon Bldg., 2-6-2, Ohte-machi, Chiyoda-ku, Tokyo 100-0004, Japan

Keep safety first in your circuit designs!

1. Renesas Technology Corp. puts the maximum effort into making semiconductor products better and more reliable, but there is always the possibility that trouble may occur with them. Trouble with semiconductors may lead to personal injury, fire or property damage.
Remember to give due consideration to safety when making your circuit designs, with appropriate measures such as (i) placement of substitutive, auxiliary circuits, (ii) use of nonflammable material or (iii) prevention against any malfunction or mishap.

Notes regarding these materials

1. These materials are intended as a reference to assist our customers in the selection of the Renesas Technology Corp. product best suited to the customer's application; they do not convey any license under any intellectual property rights, or any other rights, belonging to Renesas Technology Corp. or a third party.
 2. Renesas Technology Corp. assumes no responsibility for any damage, or infringement of any third-party's rights, originating in the use of any product data, diagrams, charts, programs, algorithms, or circuit application examples contained in these materials.
 3. All information contained in these materials, including product data, diagrams, charts, programs and algorithms represents information on products at the time of publication of these materials, and are subject to change by Renesas Technology Corp. without notice due to product improvements or other reasons. It is therefore recommended that customers contact Renesas Technology Corp. or an authorized Renesas Technology Corp. product distributor for the latest product information before purchasing a product listed herein.
The information described here may contain technical inaccuracies or typographical errors.
Renesas Technology Corp. assumes no responsibility for any damage, liability, or other loss rising from these inaccuracies or errors.
Please also pay attention to information published by Renesas Technology Corp. by various means, including the Renesas Technology Corp. Semiconductor home page (<http://www.renesas.com>).
 4. When using any or all of the information contained in these materials, including product data, diagrams, charts, programs, and algorithms, please be sure to evaluate all information as a total system before making a final decision on the applicability of the information and products. Renesas Technology Corp. assumes no responsibility for any damage, liability or other loss resulting from the information contained herein.
 5. Renesas Technology Corp. semiconductors are not designed or manufactured for use in a device or system that is used under circumstances in which human life is potentially at stake. Please contact Renesas Technology Corp. or an authorized Renesas Technology Corp. product distributor when considering the use of a product contained herein for any specific purposes, such as apparatus or systems for transportation, vehicular, medical, aerospace, nuclear, or undersea repeater use.
 6. The prior written approval of Renesas Technology Corp. is necessary to reprint or reproduce in whole or in part these materials.
 7. If these products or technologies are subject to the Japanese export control restrictions, they must be exported under a license from the Japanese government and cannot be imported into a country other than the approved destination.
Any diversion or reexport contrary to the export control laws and regulations of Japan and/or the country of destination is prohibited.
 8. Please contact Renesas Technology Corp. for further details on these materials or the products contained therein.
-



RENESAS SALES OFFICES

<http://www.renesas.com>

Renesas Technology America, Inc.
450 Holger Way, San Jose, CA 95134-1368, U.S.A
Tel: <1> (408) 382-7500 Fax: <1> (408) 382-7501

Renesas Technology Europe Limited.
Dukes Meadow, Millboard Road, Bourne End, Buckinghamshire, SL8 5FH, United Kingdom
Tel: <44> (1628) 585 100, Fax: <44> (1628) 585 900

Renesas Technology Europe GmbH
Dornacher Str. 3, D-85622 Feldkirchen, Germany
Tel: <49> (89) 380 70 0, Fax: <49> (89) 929 30 11

Renesas Technology Hong Kong Ltd.
7/F., North Tower, World Finance Centre, Harbour City, Canton Road, Hong Kong
Tel: <852> 2265-6688, Fax: <852> 2375-6836

Renesas Technology Taiwan Co., Ltd.
FL 10, #99, Fu-Hsing N. Rd., Taipei, Taiwan
Tel: <886> (2) 2715-2888, Fax: <886> (2) 2713-2999

Renesas Technology (Shanghai) Co., Ltd.
26/F., Ruijin Building, No.205 Maoming Road (S), Shanghai 200020, China
Tel: <86> (21) 6472-1001, Fax: <86> (21) 6415-2952

Renesas Technology Singapore Pte. Ltd.
1, Harbour Front Avenue, #06-10, Keppel Bay Tower, Singapore 098632
Tel: <65> 6213-0200, Fax: <65> 6278-8001