

Red Side-Emitting SMD LED (4 x 4 mm, 120° Viewing Angle)

OVS9RBCR8

- Compact size allows use in space conscious devices
- Thin profile offers unlimited design flexibility
- Long life span reduces maintenance cost
- Suitable for all SMT assembly methods
- Red (624 nm)

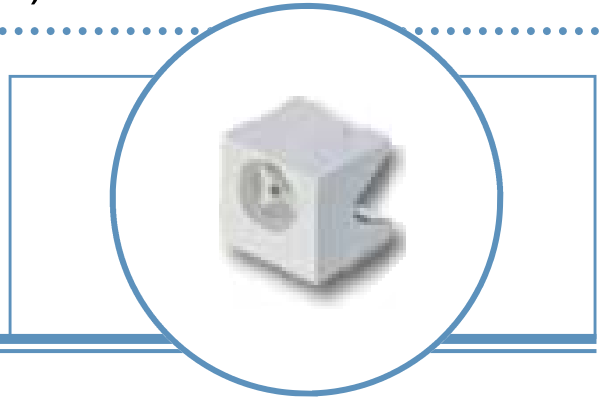

The **OVS9RBCR8** is a side-looking red 4.0 mm x 4.0 mm 120° angle surface-mounted LED that can be used as a light source in many applications. Its compact size and thin profile offer maximum design flexibility, while its long life span reduces maintenance cost.

Applications

- Optical indicators
- Coupling into light guides
- Back lights (LCD switches, keys, displays, illuminated advertising, general lighting)
- Interior automotive lighting (dashboard backlighting, etc.)
- Automotive applications
- Marker lights (e.g., steps, exit ways, etc.)
- Signal and symbol luminaire

Part Number	Material	Emitted Color	Intensity Typ. mcd	Lens Color
OVS9RBCR8	AlGaInP	Red	400	Water Clear

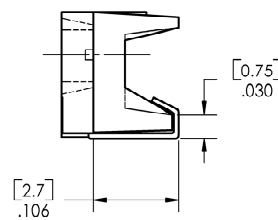
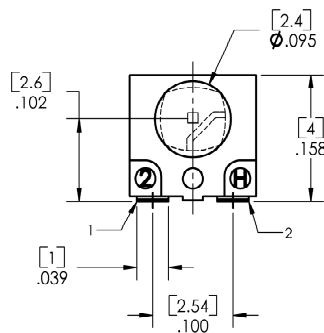
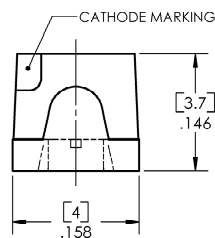

1 CATHODE 2 ANODE
DIMENSIONS ARE IN INCHES AND [MILLIMETERS].



DO NOT LOOK DIRECTLY AT LED WITH UNSHIELDED EYES OR DAMAGE TO RETINA MAY OCCUR.

OPTEK reserves the right to make changes at any time in order to improve design and to supply the best product possible.

Red Side-Emitting SMD LED

OVSR9RBCR8



Absolute Maximum Ratings

$T_A = 25^\circ\text{C}$ unless otherwise noted

Storage Temperature Range	-40 ~ +100°C
Operating Temperature Range	-40 ~ +100°C
Junction Temperature	110°C
Junction/Ambient ¹	500°C/W
Junction/Solder Point	350°C/W
Reverse Voltage	5 V
Continuous Forward Current	50 mA
Peak Forward Current (10% Duty Cycle, PW ≤ 100 μsec)	200 mA
Power Dissipation	130 mW

Note:

1. Rth test condition: Mounted on PC board FR 4 (pad size ≥ 16mm²).

Electrical Characteristics

$T_A = 25^\circ\text{C}$ unless otherwise noted

SYMBOL	PARAMETER	MIN	TYP	MAX	UNITS	CONDITIONS
I_V	Luminous Intensity	280	400	----	mcd	$I_F = 20\text{ mA}$
V_F	Forward Voltage	----	2.3	2.6	V	$I_F = 20\text{ mA}$
I_R	Reverse Current	----	----	10	μA	$V_R = 5\text{ V}$
λ_D	Dominant Wavelength	620	628	635	nm	$I_F = 20\text{ mA}$
$2\theta_{1/2}$	50% Power Angle	----	120	----	deg	$I_F = 20\text{ mA}$

Standard Bins ($I_F = 20\text{mA}$)

Lamps are sorted to luminous intensity (I_V) and dominant wavelength (λ_D) bins shown. Orders for OVSR9RBCR8 may be filled with any or all bins contained as below.

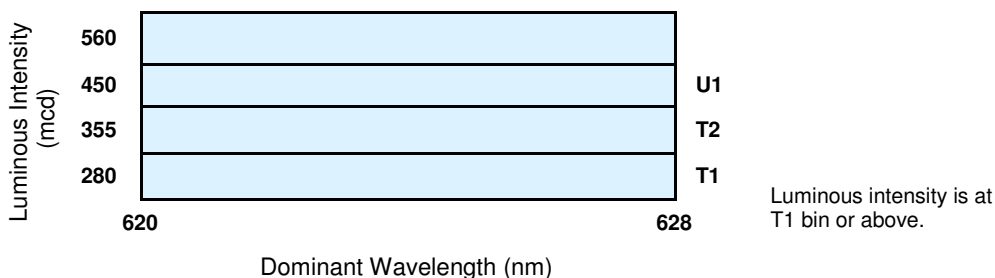

Notes:

1. All ranks will be included per delivery, rank ratio will be based on the chip distribution.
2. To designate luminous intensity ranks, please contact OPTEK.

OPTEK reserves the right to make changes at any time in order to improve design and to supply the best product possible.

Typical Electro-Optical Characteristics Curves

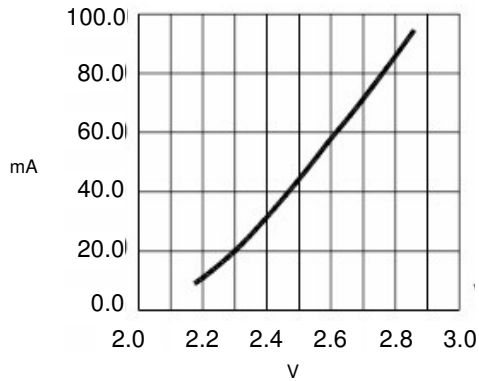

Forward Current vs Forward Voltage

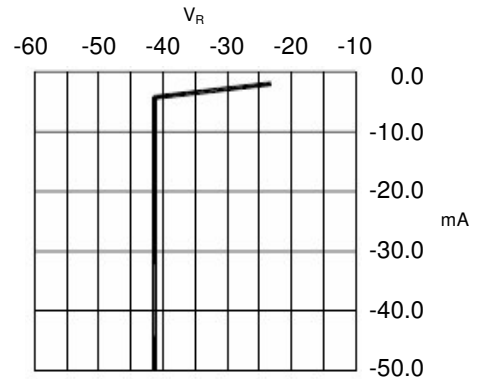

Reverse Current vs Reverse Voltage

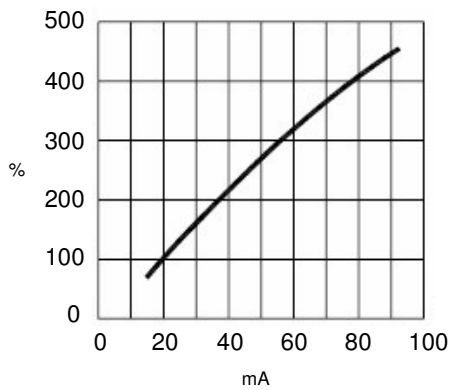

Relative Luminous Intensity vs Forward Current

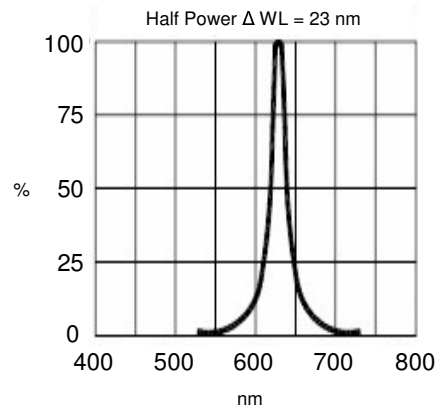

Relative Luminous Intensity vs Wavelength

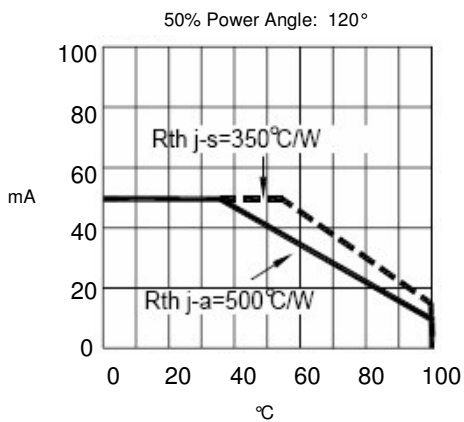

Maximum Forward Current vs Ambient Temperature

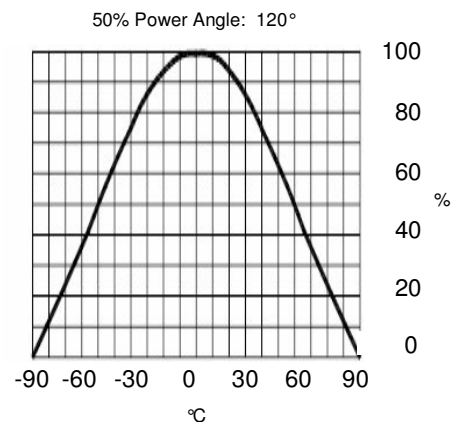

Far Field Pattern

OPTEK reserves the right to make changes at any time in order to improve design and to supply the best product possible.

Red Side-Emitting SMD LED

OVSR9RBCR8



Reel Dimensions: 7-inch reel

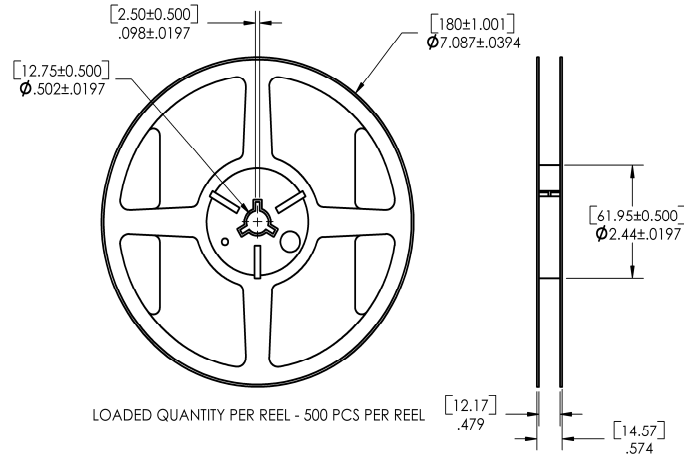

Carrier Tape Dimensions: Loaded quantity 500 pieces per reel

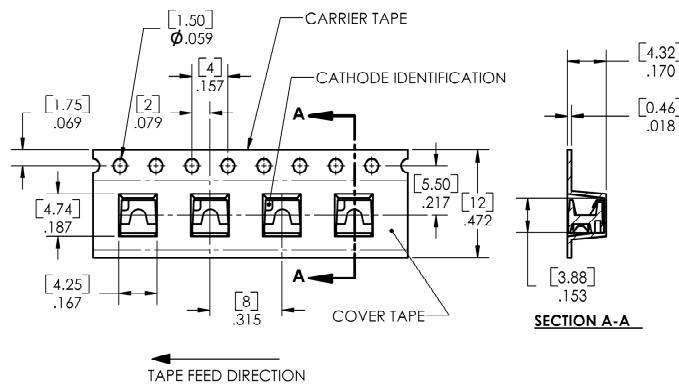

DIMENSIONS ARE IN INCHES AND [MILLIMETERS].
TOLERANCES ARE ± 0.0039 [0.1] UNLESS OTHERWISE SPECIFIED.

Moisture Resistant Packaging

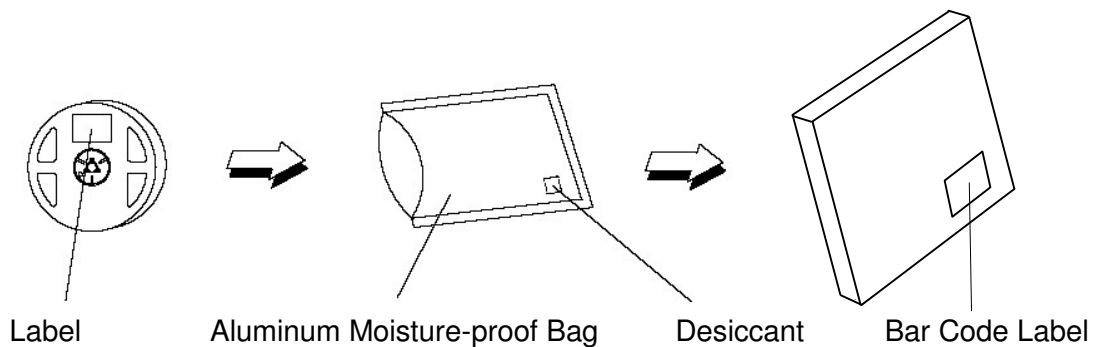

OPTEK reserves the right to make changes at any time in order to improve design and to supply the best product possible.