

***Buck chopper
MOSFET Power Module***

**$V_{DSS} = 1200V$
 $R_{DSon} = 150m\Omega \text{ max @ } T_j = 25^\circ C$
 $I_D = 60A \text{ @ } T_c = 25^\circ C$**

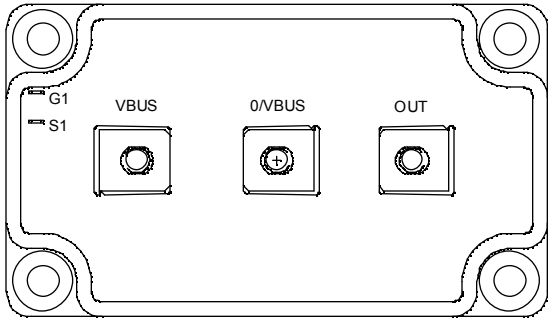
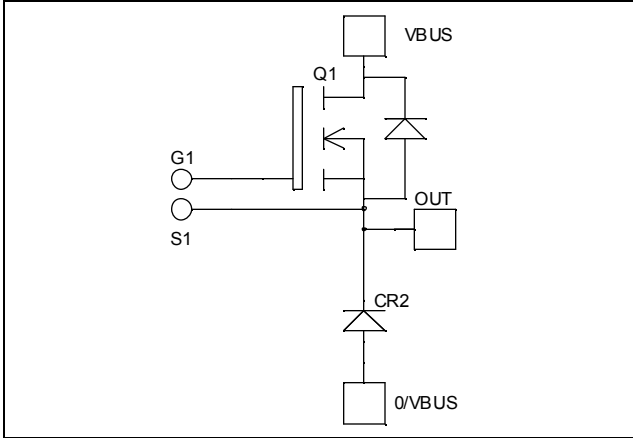

Application

- AC and DC motor control
- Switched Mode Power Supplies

Features

- Power MOS 7[®] MOSFETs
 - Low R_{DSon}
 - Low input and Miller capacitance
 - Low gate charge
 - Avalanche energy rated
 - Very rugged
- Kelvin source for easy drive
- Very low stray inductance
 - Symmetrical design
 - M5 power connectors
- High level of integration

Benefits

- Outstanding performance at high frequency operation
- Direct mounting to heatsink (isolated package)
- Low junction to case thermal resistance
- Low profile

Absolute maximum ratings

Symbol	Parameter	Max ratings	Unit
V_{DSS}	Drain - Source Breakdown Voltage	1200	V
I_D	Continuous Drain Current	$T_c = 25^\circ C$	A
		$T_c = 80^\circ C$	
I_{DM}	Pulsed Drain current	240	
V_{GS}	Gate - Source Voltage	± 30	V
R_{DSon}	Drain - Source ON Resistance	150	$m\Omega$
P_D	Maximum Power Dissipation	$T_c = 25^\circ C$	1250
I_{AR}	Avalanche current (repetitive and non repetitive)	22	A
E_{AR}	Repetitive Avalanche Energy	50	mJ
E_{AS}	Single Pulse Avalanche Energy	3000	

CAUTION: These Devices are sensitive to Electrostatic Discharge. Proper Handling Procedures Should Be Followed.

All ratings @ $T_j = 25^\circ\text{C}$ unless otherwise specified

Electrical Characteristics

Symbol	Characteristic	Test Conditions	Min	Typ	Max	Unit
BV_{DSS}	Drain - Source Breakdown Voltage	$V_{GS} = 0V, I_D = 1mA$	1200			V
I_{DSS}	Zero Gate Voltage Drain Current	$V_{GS} = 0V, V_{DS} = 1200V$ $T_j = 25^\circ\text{C}$			400	μA
		$V_{GS} = 0V, V_{DS} = 1000V$ $T_j = 125^\circ\text{C}$			2000	
$R_{DS(on)}$	Drain - Source on Resistance	$V_{GS} = 10V, I_D = 30A$			150	$\text{m}\Omega$
$V_{GS(th)}$	Gate Threshold Voltage	$V_{GS} = V_{DS}, I_D = 10mA$	3		5	V
I_{GSS}	Gate - Source Leakage Current	$V_{GS} = \pm 30V, V_{DS} = 0V$			± 250	nA

Dynamic Characteristics

Symbol	Characteristic	Test Conditions	Min	Typ	Max	Unit
C_{iss}	Input Capacitance	$V_{GS} = 0V$ $V_{DS} = 25V$ $f = 1MHz$		20.6		nF
C_{oss}	Output Capacitance			3.08		
C_{rss}	Reverse Transfer Capacitance			0.52		
Q_g	Total gate Charge	$V_{GS} = 10V$ $V_{Bus} = 600V$ $I_D = 60A$		748		nC
Q_{gs}	Gate - Source Charge			96		
Q_{gd}	Gate - Drain Charge			480		
$T_{d(on)}$	Turn-on Delay Time	Inductive switching @ 125°C $V_{GS} = 15V$ $V_{Bus} = 800V$ $I_D = 60A$ $R_G = 1.2\Omega$		20		ns
T_r	Rise Time			15		
$T_{d(off)}$	Turn-off Delay Time			160		
T_f	Fall Time			45		
E_{on}	Turn-on Switching Energy ❶	Inductive switching @ 25°C $V_{GS} = 15V, V_{Bus} = 800V$ $I_D = 60A, R_G = 1.2\Omega$		3.96		mJ
E_{off}	Turn-off Switching Energy ❷			2.74		
E_{on}	Turn-on Switching Energy ❶	Inductive switching @ 125°C $V_{GS} = 15V, V_{Bus} = 800V$ $I_D = 60A, R_G = 1.2\Omega$		6.26		mJ
E_{off}	Turn-off Switching Energy ❷			3.43		

Diode ratings and characteristics

Symbol	Characteristic	Test Conditions	Min	Typ	Max	Unit
$I_{F(AV)}$	Maximum Average Forward Current	50% duty cycle $T_c = 70^\circ\text{C}$		60		A
V_F	Diode Forward Voltage	$I_F = 60A$		2	2.5	V
		$I_F = 120A$		2.3		
		$I_F = 60A$ $T_j = 125^\circ\text{C}$		1.8		
t_{rr}	Reverse Recovery Time	$I_F = 60A$ $V_R = 800V$ $di/dt = 200A/\mu\text{s}$ $T_j = 25^\circ\text{C}$		400		ns
		$T_j = 125^\circ\text{C}$		470		
Q_{rr}	Reverse Recovery Charge	$I_F = 60A$ $V_R = 800V$ $di/dt = 200A/\mu\text{s}$ $T_j = 25^\circ\text{C}$		1200		nC
		$T_j = 125^\circ\text{C}$		4000		

❶ E_{on} includes diode reverse recovery.

❷ In accordance with JEDEC standard JESD24-1.

Typical Performance Curve

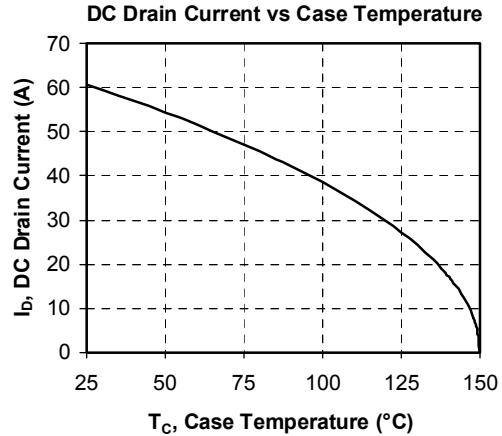
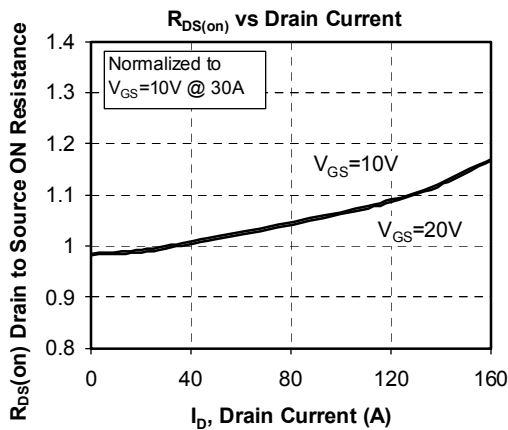
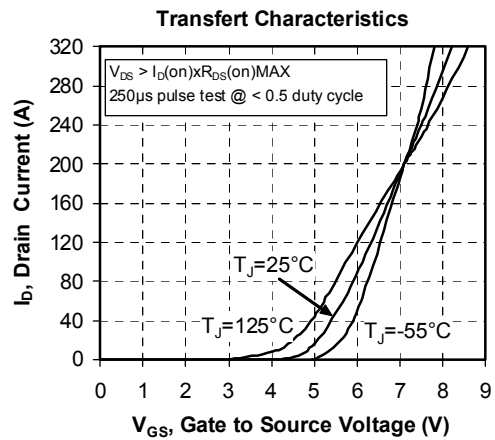
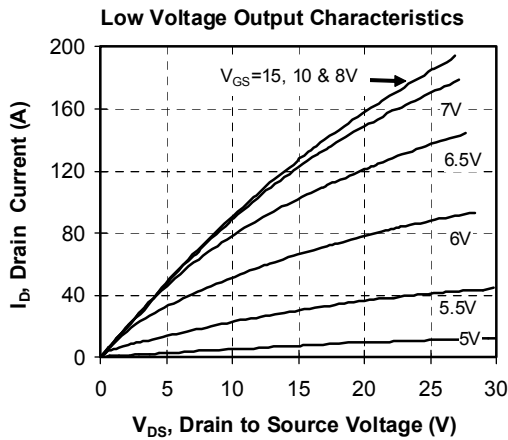
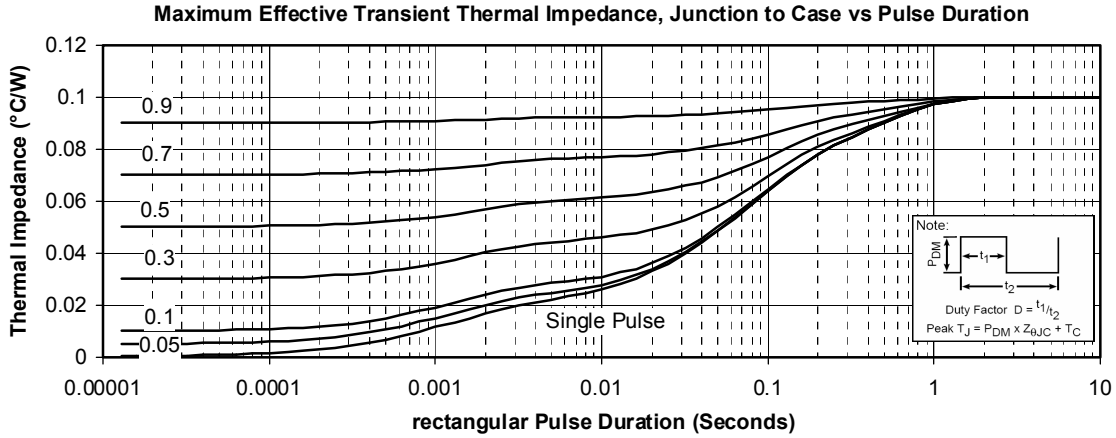

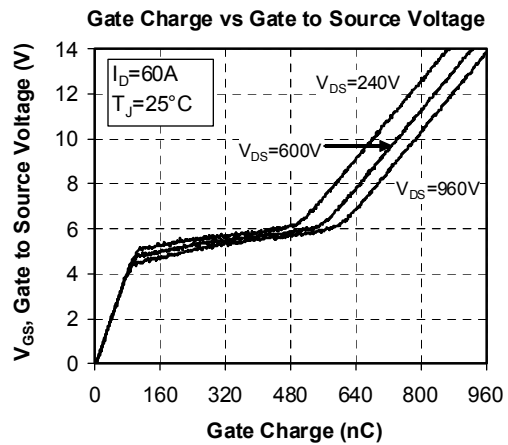
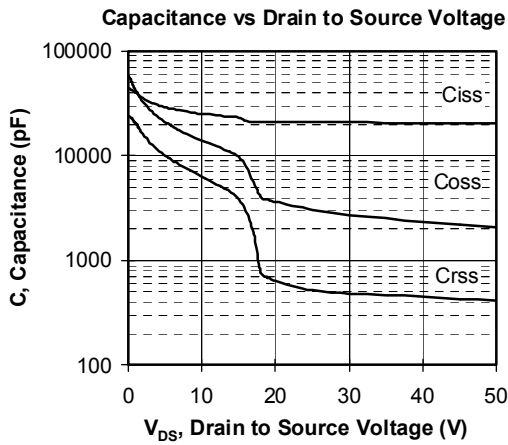
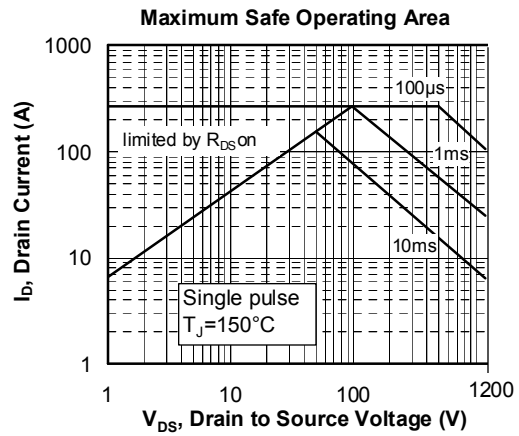
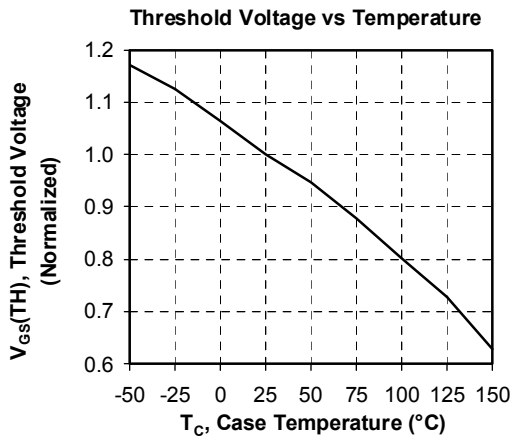
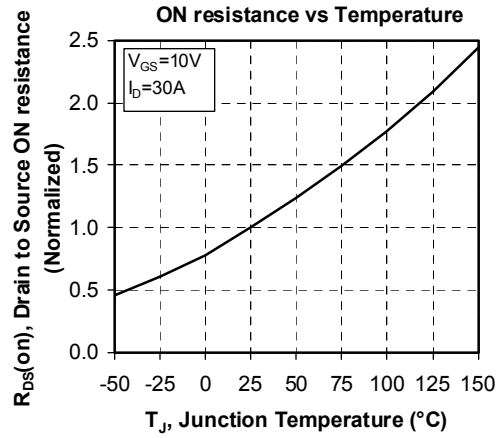
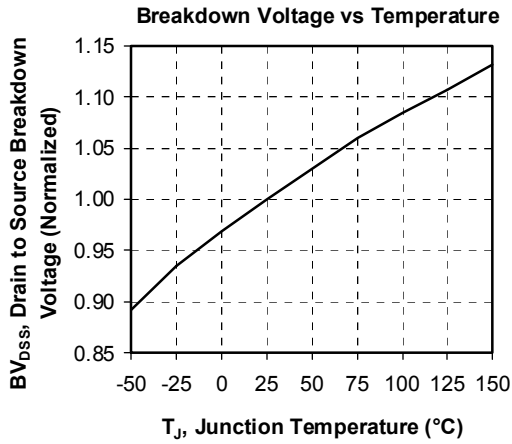

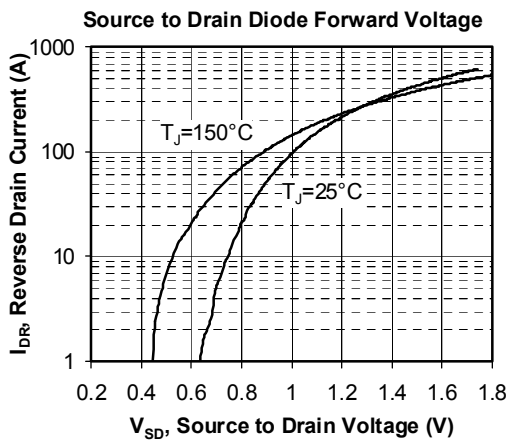
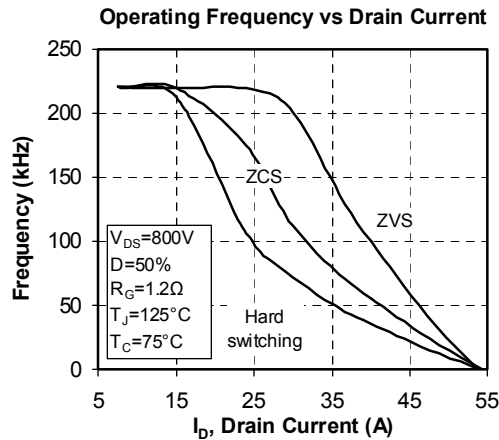
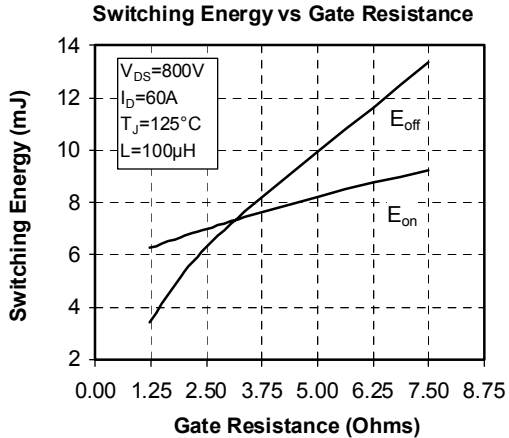
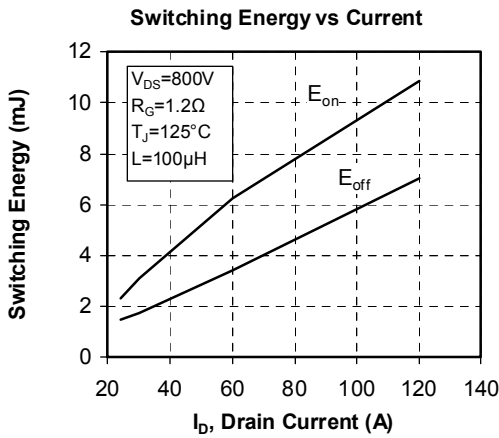
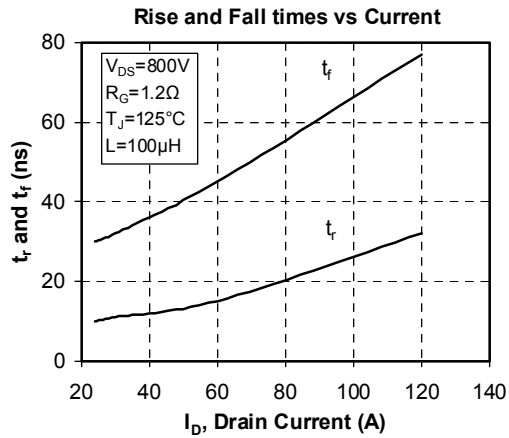
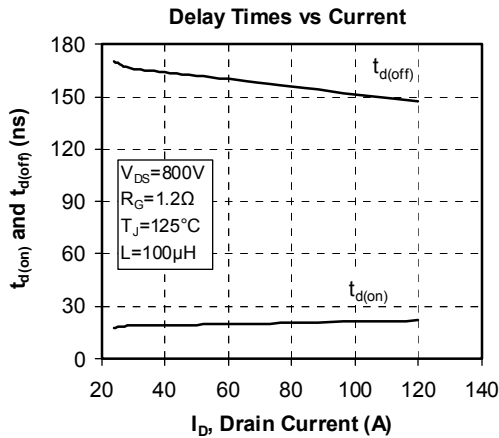

APT reserves the right to change, without notice, the specifications and information contained herein

APT's products are covered by one or more of U.S. patents 4,895,810 5,045,903 5,089,434 5,182,234 5,019,522 5,262,336 6,503,786 5,256,583 4,748,103 5,283,202 5,231,474 5,434,095 5,528,058 and foreign patents. U.S. and Foreign patents pending. All Rights Reserved.