

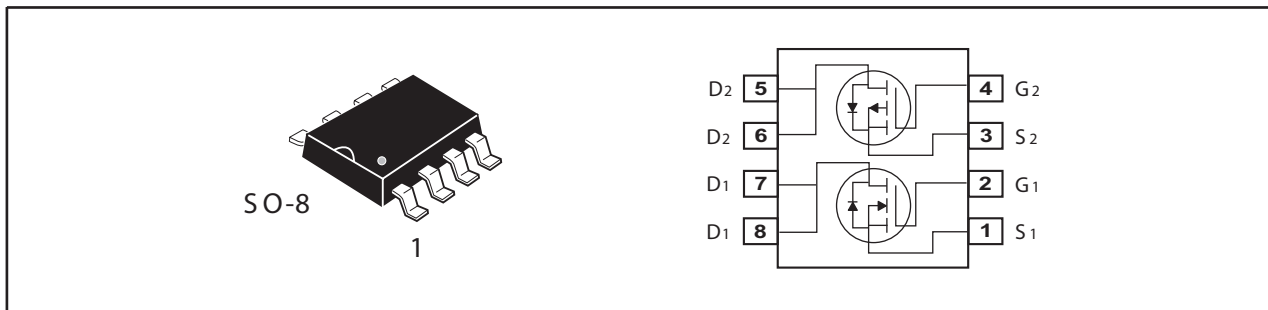

## Dual Enhancement Mode Field Effect Transistor ( N and P Channel )

PRODUCT SUMMARY (N-Channel)		
V <sub>DSS</sub>	I <sub>D</sub>	R <sub>DS(ON)</sub> (mΩ) Max
40V	6.2A	33 @ V <sub>GS</sub> =10V
		45 @ V <sub>GS</sub> =4.5V

PRODUCT SUMMARY (P-Channel)		
V <sub>DSS</sub>	I <sub>D</sub>	R <sub>DS(ON)</sub> (mΩ) Max
-40V	-5.3A	45 @ V <sub>GS</sub> =-10V
		70 @ V <sub>GS</sub> =-4.5V



### ABSOLUTE MAXIMUM RATINGS (T<sub>A</sub>=25°C unless otherwise noted)

Symbol	Parameter	N-Channel	P-Channel	Units	
V <sub>DS</sub>	Drain-Source Voltage	40	-40	V	
V <sub>GS</sub>	Gate-Source Voltage	±20	±20	V	
I <sub>D</sub>	Drain Current-Continuous <sup>a</sup>	T <sub>A</sub> =25°C	6.2	-5.3	A
		T <sub>A</sub> =70°C	4.9	-4.2	A
I <sub>DM</sub>	-Pulsed <sup>b</sup>	25	-22	A	
E <sub>AS</sub>	Single Pulse Avalanche Energy <sup>d</sup>	9	16	mJ	
P <sub>D</sub>	Maximum Power Dissipation <sup>a</sup>	T <sub>A</sub> =25°C	2	W	
		T <sub>A</sub> =70°C	1.28		
T <sub>J</sub> , T <sub>STG</sub>	Operating Junction and Storage Temperature Range	-55 to 150		°C	

### THERMAL CHARACTERISTICS

R <sub>θJA</sub>	Thermal Resistance, Junction-to-Ambient <sup>a</sup>	62.5	°C/W
------------------	--	------	------

# STM8456

Ver 1.0

## N-Channel ELECTRICAL CHARACTERISTICS (TA=25°C unless otherwise noted)

Symbol	Parameter	Conditions	Min	Typ	Max	Units
<b>OFF CHARACTERISTICS</b>						
BV <sub>DSS</sub>	Drain-Source Breakdown Voltage	V <sub>GS</sub> =0V, I <sub>D</sub> =250μA	40			V
I <sub>DSS</sub>	Zero Gate Voltage Drain Current	V <sub>DS</sub> =32V, V <sub>GS</sub> =0V			1	μA
I <sub>GSS</sub>	Gate-Body Leakage Current	V <sub>GS</sub> = ±20V, V <sub>DS</sub> =0V			±100	nA
<b>ON CHARACTERISTICS</b> <sup>a</sup>						
V <sub>GS(th)</sub>	Gate Threshold Voltage	V <sub>DS</sub> =V <sub>GS</sub> , I <sub>D</sub> =250μA	1	1.5	3	V
R <sub>DS(ON)</sub>	Drain-Source On-State Resistance	V <sub>GS</sub> =10V, I <sub>D</sub> =6.2A		26	33	m ohm
		V <sub>GS</sub> =4.5V, I <sub>D</sub> =5.3A		33	45	m ohm
g <sub>FS</sub>	Forward Transconductance	V <sub>DS</sub> =10V, I <sub>D</sub> =6.2A		13.8		S
<b>DYNAMIC CHARACTERISTICS</b> <sup>c</sup>						
C <sub>ISS</sub>	Input Capacitance	V <sub>DS</sub> =20V, V <sub>GS</sub> =0V f=1.0MHz		580		pF
C <sub>OSS</sub>	Output Capacitance			82		pF
C <sub>RSS</sub>	Reverse Transfer Capacitance			50		pF
<b>SWITCHING CHARACTERISTICS</b> <sup>c</sup>						
t <sub>D(ON)</sub>	Turn-On Delay Time	V <sub>DD</sub> =20V I <sub>D</sub> =1A V <sub>GS</sub> =10V R <sub>GEN</sub> =3.3 ohm		11		ns
t <sub>r</sub>	Rise Time			10.2		ns
t <sub>D(OFF)</sub>	Turn-Off Delay Time			17.3		ns
t <sub>f</sub>	Fall Time			20		ns
Q <sub>g</sub>	Total Gate Charge	V <sub>DS</sub> =20V, I <sub>D</sub> =6.2A, V <sub>GS</sub> =10V		11.3		nC
		V <sub>DS</sub> =20V, I <sub>D</sub> =5.3A, V <sub>GS</sub> =4.5V		5.8		nC
Q <sub>gs</sub>	Gate-Source Charge	V <sub>DS</sub> =20V, I <sub>D</sub> =6.2A, V <sub>GS</sub> =10V		1.2		nC
Q <sub>gd</sub>	Gate-Drain Charge			2.9		nC
<b>DRAIN-SOURCE DIODE CHARACTERISTICS</b>						
V <sub>SD</sub>	Diode Forward Voltage <sup>b</sup>	V <sub>GS</sub> =0V, I <sub>S</sub> =1.3A		0.79	1.2	V

May,29,2008

# STM8456

Ver 1.0

## P-Channel ELECTRICAL CHARACTERISTICS (TA=25°C unless otherwise noted)

Symbol	Parameter	Conditions	Min	Typ	Max	Units
<b>OFF CHARACTERISTICS</b>						
BV <sub>DSS</sub>	Drain-Source Breakdown Voltage	V <sub>GS</sub> =0V, I <sub>D</sub> =-250uA	-40			V
I <sub>DSS</sub>	Zero Gate Voltage Drain Current	V <sub>DS</sub> =-32V, V <sub>GS</sub> =0V			-1	uA
I <sub>GSS</sub>	Gate-Body Leakage Current	V <sub>GS</sub> = ±20V, V <sub>DS</sub> =0V			±100	nA
<b>ON CHARACTERISTICS</b>						
V <sub>GS(th)</sub>	Gate Threshold Voltage	V <sub>DS</sub> =V <sub>GS</sub> , I <sub>D</sub> =-250uA	-1	-1.7	-3	V
R <sub>DS(ON)</sub>	Drain-Source On-State Resistance	V <sub>GS</sub> =-10V, I <sub>D</sub> =-5.3A		36	45	m ohm
		V <sub>GS</sub> =-4.5V, I <sub>D</sub> =-4.3A		52	70	m ohm
g <sub>FS</sub>	Forward Transconductance	V <sub>DS</sub> =-10V, I <sub>D</sub> =-5.3A		12		S
<b>DYNAMIC CHARACTERISTICS °</b>						
C <sub>ISS</sub>	Input Capacitance	V <sub>DS</sub> =-20V, V <sub>GS</sub> =0V f=1.0MHz		980		pF
C <sub>OSS</sub>	Output Capacitance			135		pF
C <sub>RSS</sub>	Reverse Transfer Capacitance			90		pF
<b>SWITCHING CHARACTERISTICS °</b>						
t <sub>D(ON)</sub>	Turn-On Delay Time	V <sub>DD</sub> =-20V I <sub>D</sub> =-1A V <sub>GS</sub> =-10V R <sub>GEN</sub> =3.3 ohm		12		ns
t <sub>r</sub>	Rise Time			17		ns
t <sub>D(OFF)</sub>	Turn-Off Delay Time			82		ns
t <sub>f</sub>	Fall Time			35		ns
Q <sub>g</sub>	Total Gate Charge	V <sub>DS</sub> =-20V, I <sub>D</sub> =-5.3A, V <sub>GS</sub> =-10V		20.7		nC
		V <sub>DS</sub> =-20V, I <sub>D</sub> =-4.3A, V <sub>GS</sub> =-4.5V		11		nC
Q <sub>gs</sub>	Gate-Source Charge	V <sub>DS</sub> =-20V, I <sub>D</sub> =-5.3A,		1.5		nC
Q <sub>gd</sub>	Gate-Drain Charge	V <sub>GS</sub> =-10V		6.2		nC
<b>DRAIN-SOURCE DIODE CHARACTERISTICS</b>						
V <sub>SD</sub>	Diode Forward Voltage <sup>b</sup>	V <sub>GS</sub> =0V, I <sub>S</sub> =-1.3A		-0.78	-1.2	V

### Notes

- Surface Mounted on FR4 Board, t ≤ 10sec.
- Pulse Test: Pulse Width ≤ 300us, Duty Cycle ≤ 2%.
- Guaranteed by design, not subject to production testing.
- Starting T<sub>J</sub>=25°C, V<sub>DD</sub> = 20V, V<sub>GS</sub>=10V, L=0.5mH.

May,29,2008

## N-Channel

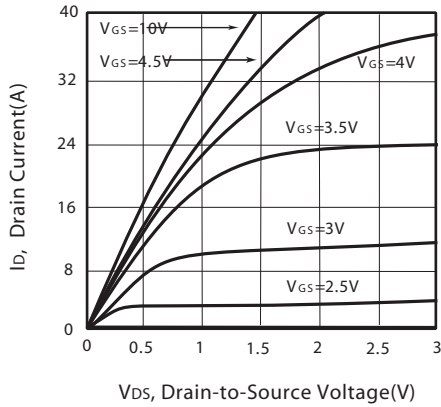

Figure 1. Output Characteristics

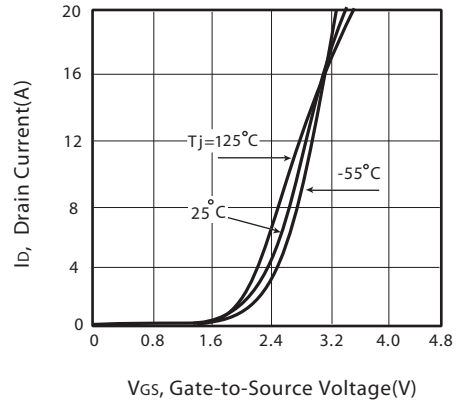

Figure 2. Transfer Characteristics

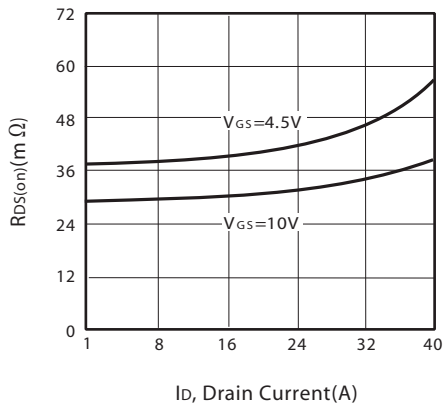

Figure 3. On-Resistance vs. Drain Current and Gate Voltage

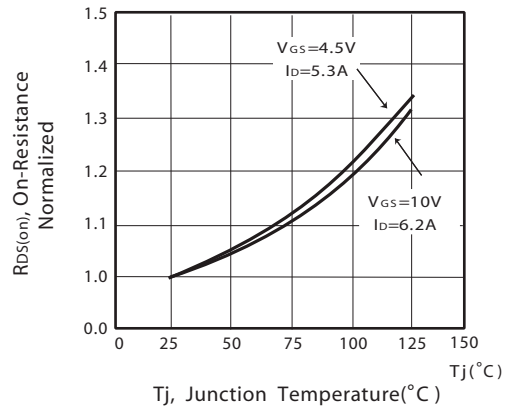

Figure 4. On-Resistance Variation with Drain Current and Temperature

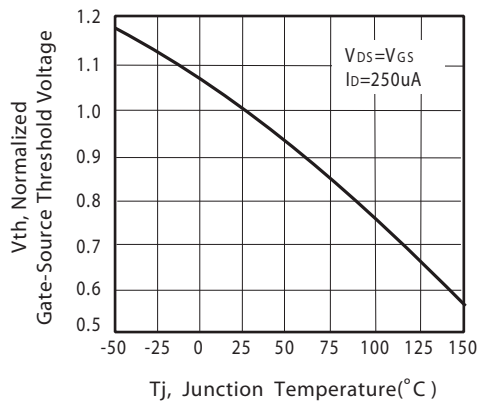

Figure 5. Gate Threshold Variation with Temperature

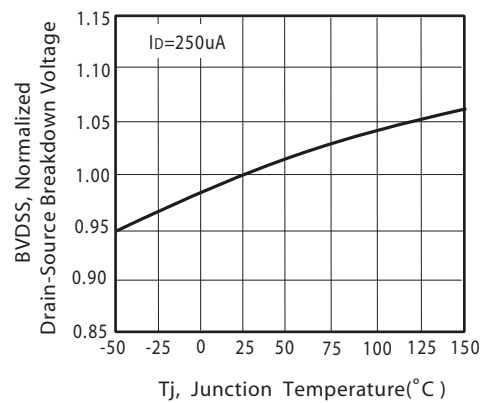

Figure 6. Breakdown Voltage Variation with Temperature

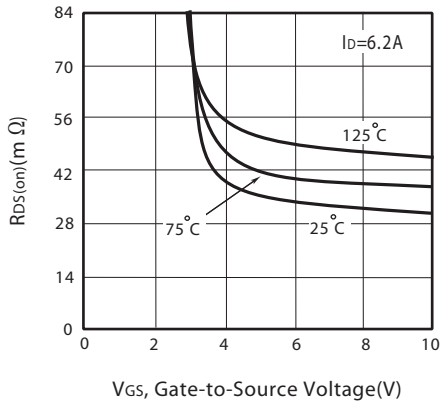

Figure 7. On-Resistance vs. Gate-Source Voltage

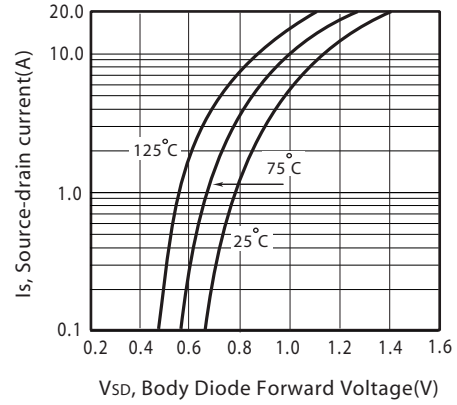

Figure 8. Body Diode Forward Voltage Variation with Source Current

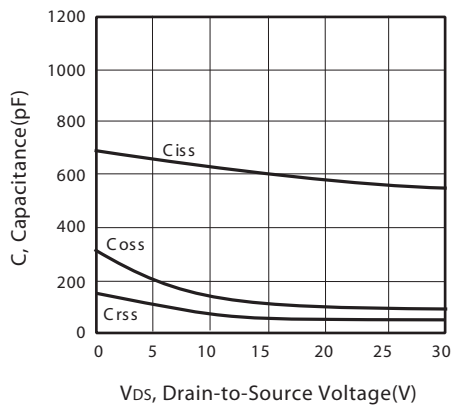

Figure 9. Capacitance

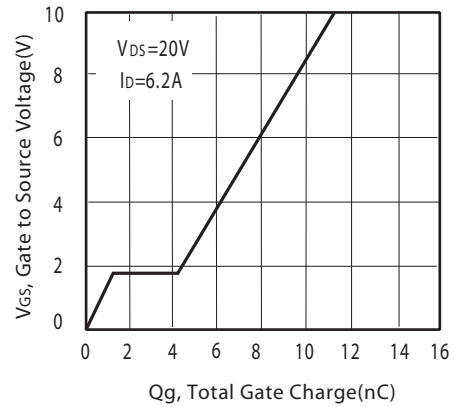

Figure 10. Gate Charge

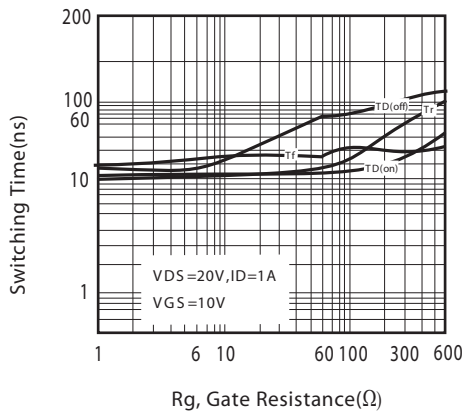

Figure 11. switching characteristics

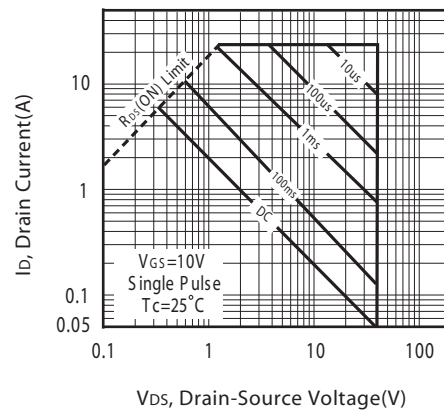
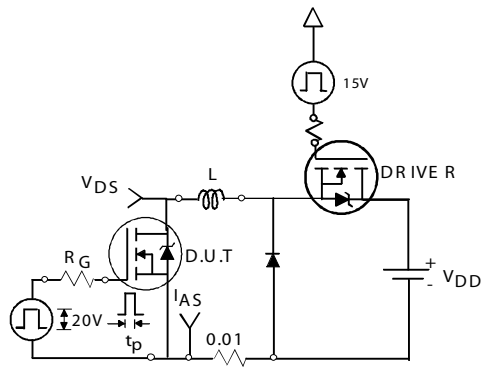
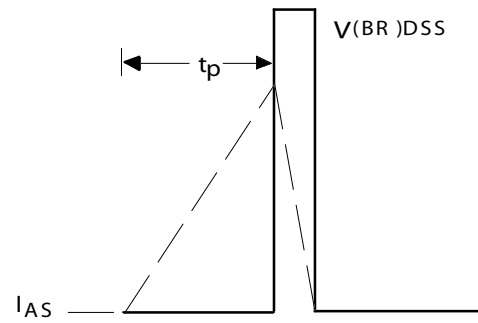

Figure 12. Maximum Safe Operating Area



Unclamped Inductive Test Circuit

Figure 13a.



Unclamped Inductive Waveforms

Figure 13b.

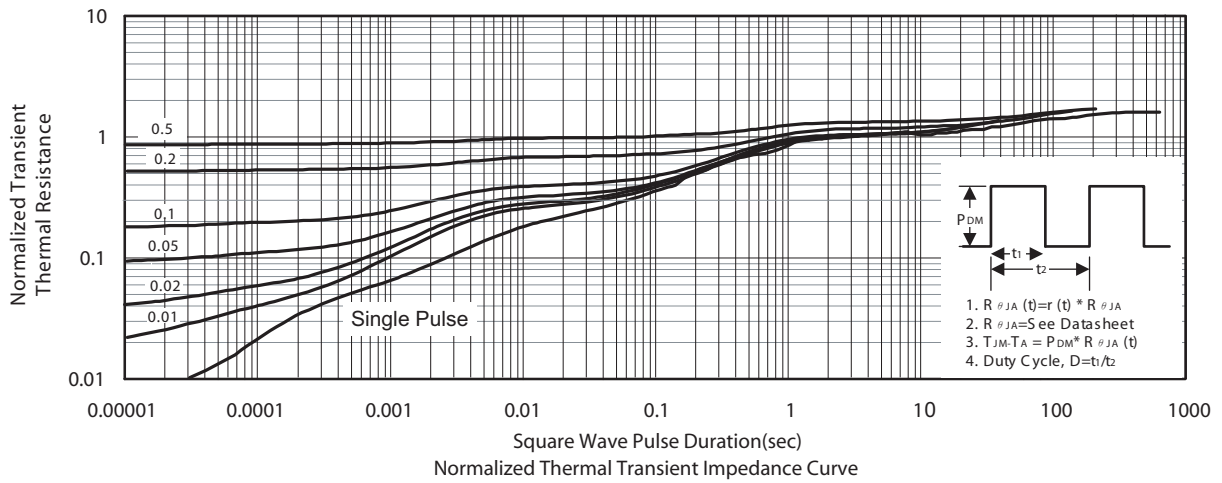

P-Channel

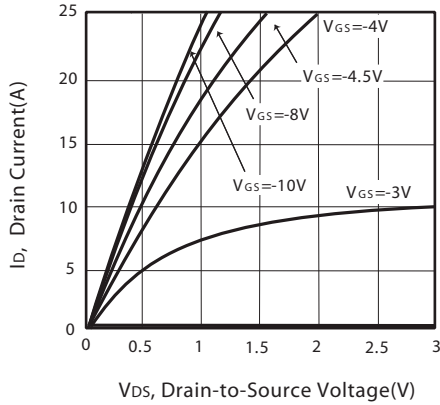

Figure 1. Output Characteristics

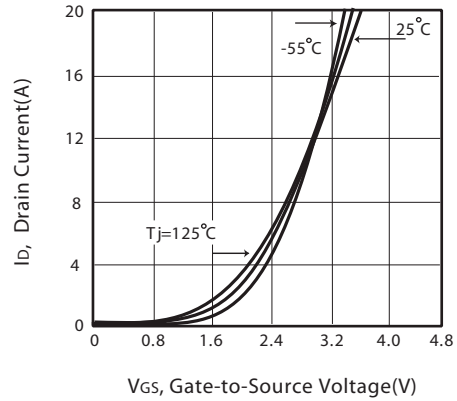

Figure 2. Transfer Characteristics

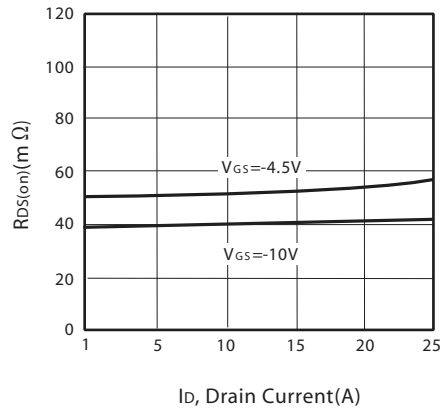

Figure 3. On-Resistance vs. Drain Current and Gate Voltage

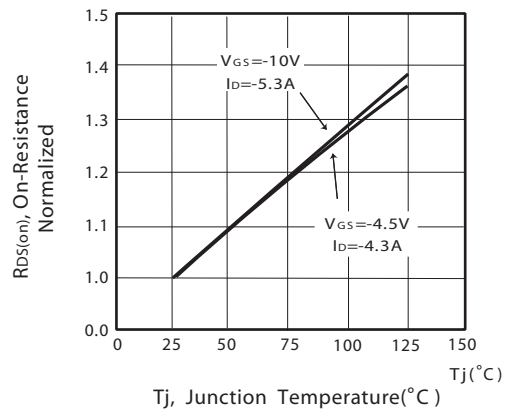

Figure 4. On-Resistance Variation with Drain Current and Temperature

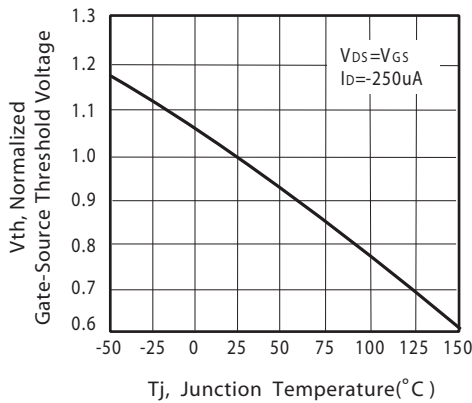

Figure 5. Gate Threshold Variation with Temperature

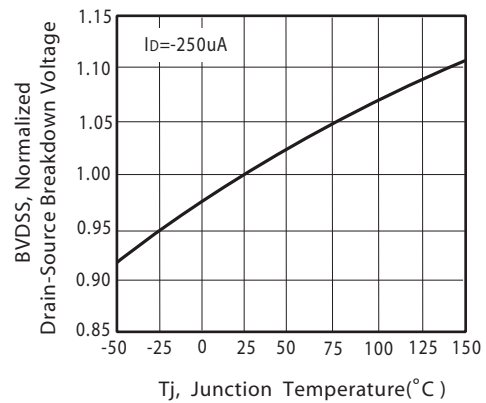

Figure 6. Breakdown Voltage Variation with Temperature

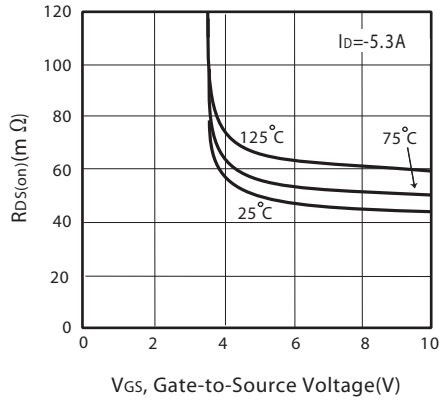

Figure 7. On-Resistance vs. Gate-Source Voltage

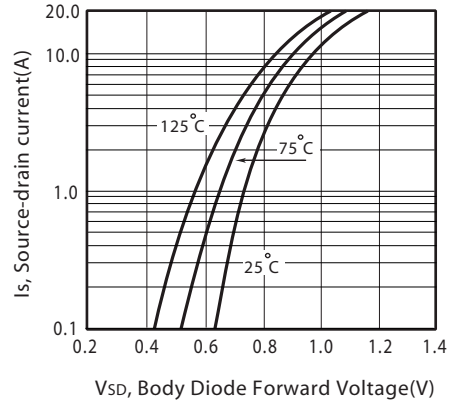

Figure 8. Body Diode Forward Voltage Variation with Source Current

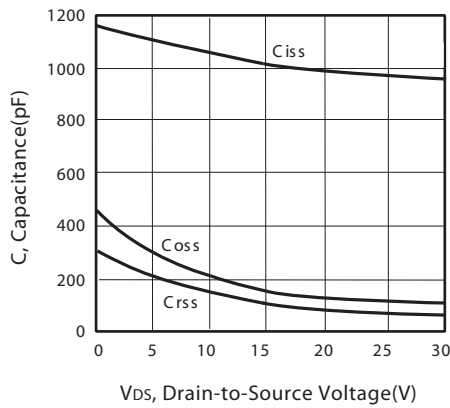

Figure 9. Capacitance

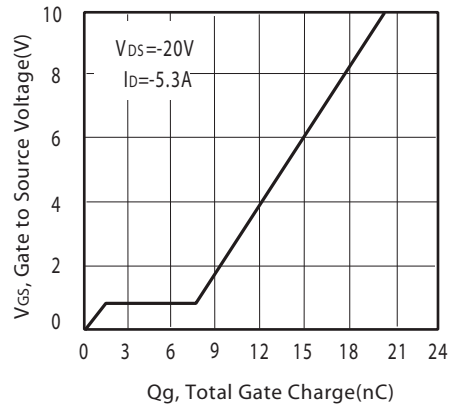

Figure 10. Gate Charge

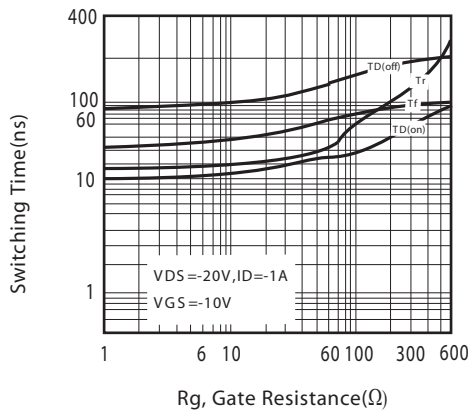

Figure 11. switching characteristics

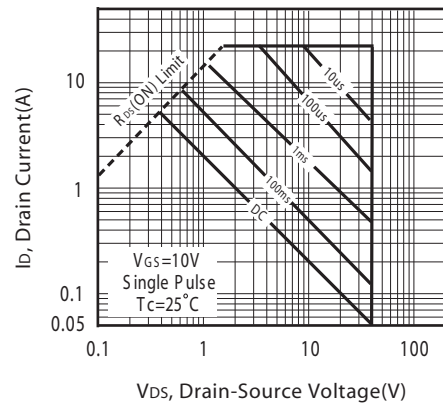
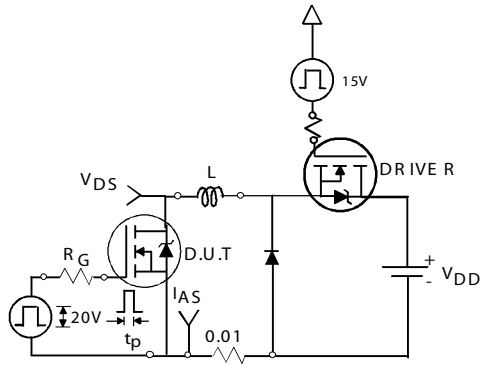

Figure 12. Maximum Safe Operating Area





Unclamped Inductive Test Circuit

Figure 13a.

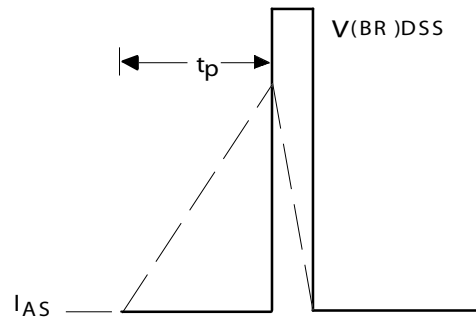

Unclamped Inductive Waveforms

Figure 13b.

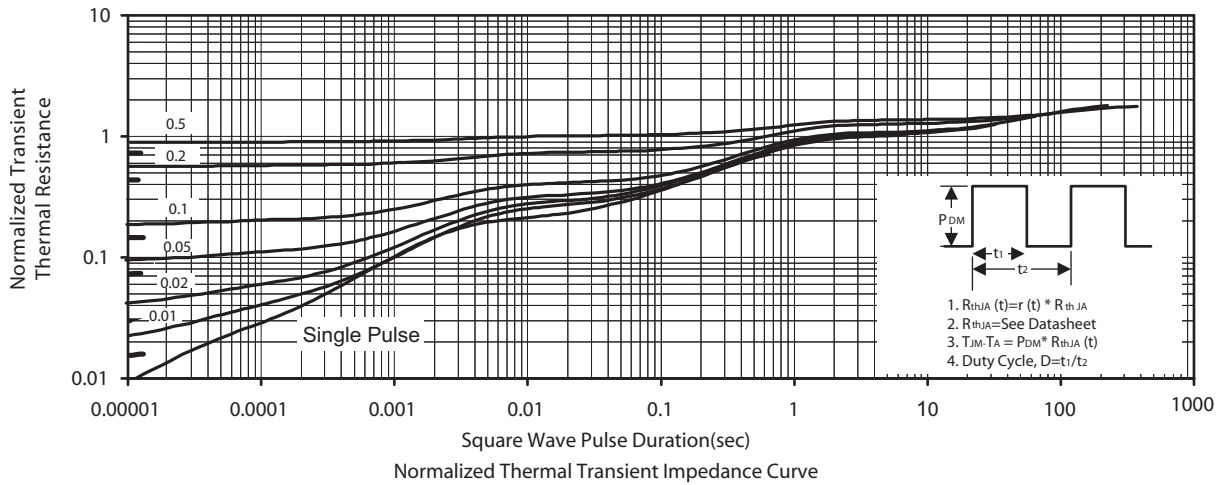

## PACKAGE OUTLINE DIMENSIONS

SO-8

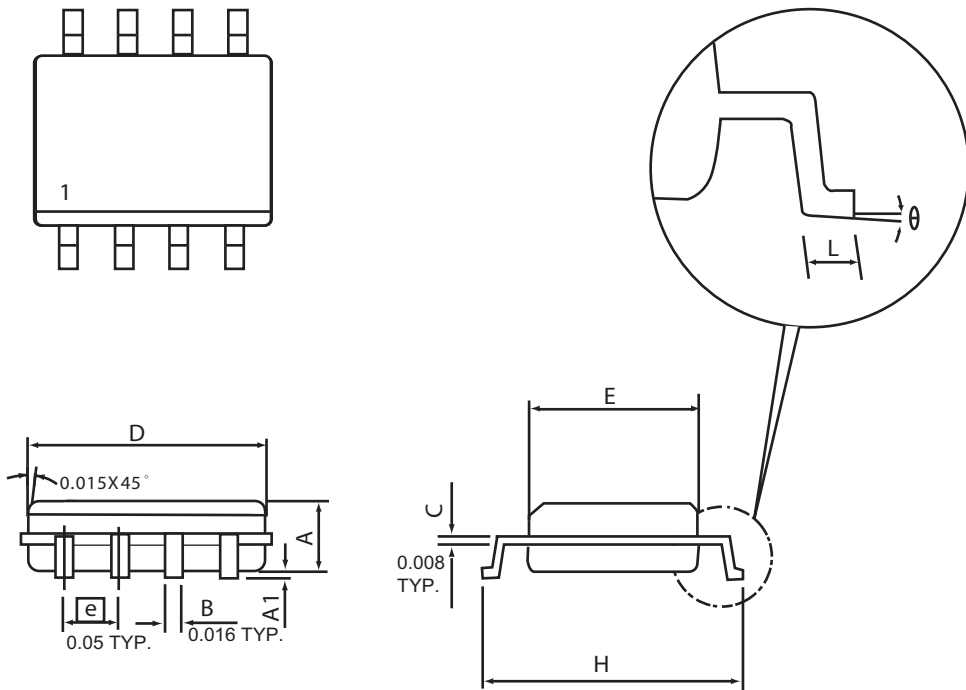

SYMBOLS	MILLIMETERS		INCHES	
	MIN	MAX	MIN	MAX
A	1.35	1.75	0.053	0.069
A1	0.10	0.25	0.004	0.010
D	4.80	4.98	0.189	0.196
E	3.81	3.99	0.150	0.157
H	5.79	6.20	0.228	0.244
L	0.41	1.27	0.016	0.050
θ	0°	8°	0°	8°

## SO-8 Tape and Reel Data

### SO-8 Carrier Tape

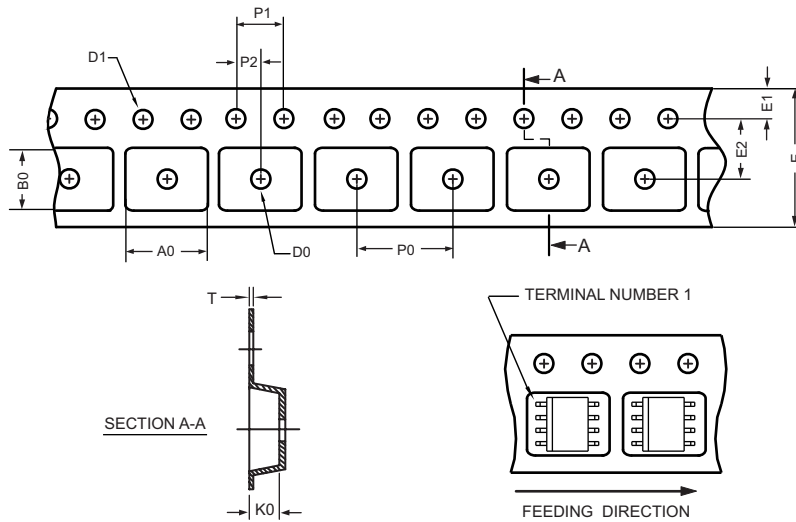

unit:mm

PACKAGE	A0	B0	K0	D0	D1	E	E1	E2	P0	P1	P2	T
SOP 8N 150mil	6.50 ±0.15	5.25 ±0.10	2.10 ±0.10	φ 1.5 (MIN)	φ 1.55 ±0.10	12.0 +0.3 - 0.1	1.75 ±0.10	5.5 ±0.10	8.0 ±0.10	4.0 ±0.10	2.0 ±0.10	0.30 ±0.013

### SO-8 Reel

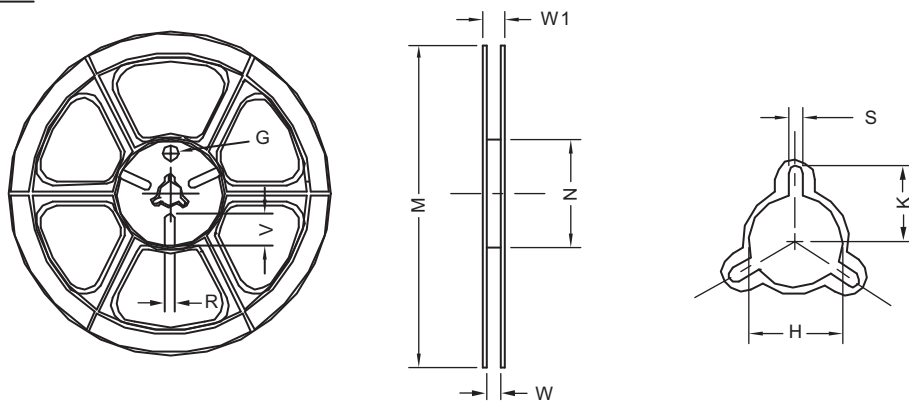

UNIT:mm

TAPE SIZE	REEL SIZE	M	N	W	W1	H	K	S	G	R	V
12 mm	φ 330	330 ± 1	62 ±1.5	12.4 + 0.2	16.8 - 0.4	φ 12.75 + 0.15	---	2.0 ±0.15	---	---	---