

THE DRAWINGS AND INFORMATION CONTAINED HEREIN ARE THE EXCLUSIVE PROPERTY OF ACTEL.
 THE INFORMATION, DRAWINGS AND DESIGN CONCEPTS CONTAINED HEREIN ARE CONFIDENTIAL/PROPRIETARY, SHALL
 BE MAINTAINED IN STRICT CONFIDENCE, AND SHALL NOT BE RELEASED TO ANY THIRD PARTY WITHOUT THE EXPRESS
 WRITTEN PERMISSION OF ACTEL.

ECN NO.	REV.	DESCRIPTION OF CHANGE	EFFECTIVE DATE	ORIGINATOR
2007409	0	initial	06/15/2007	Lijie Zhao

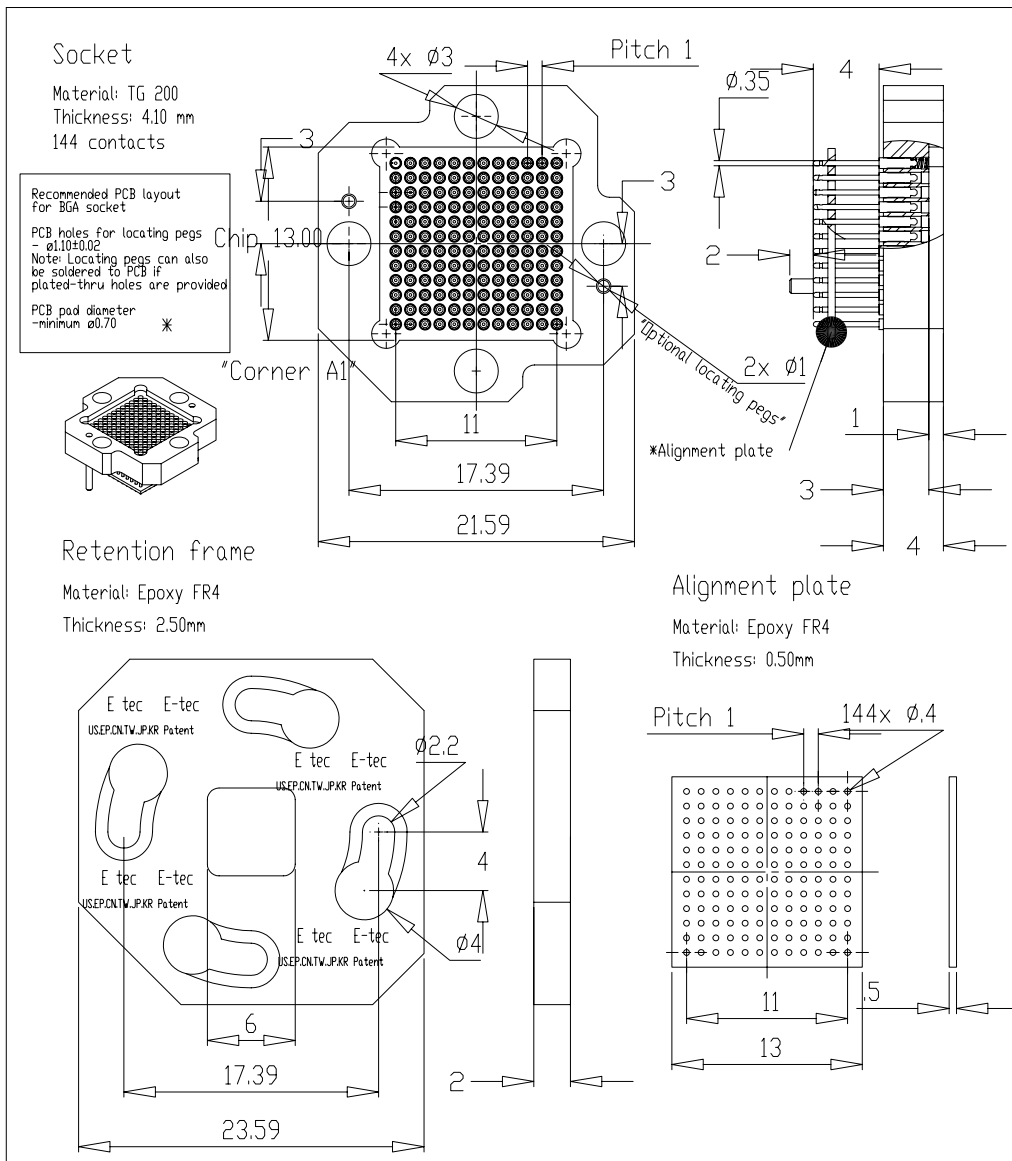

ASSEMBLY FLOW
 ↓
 Retention Frame
 ↓
 BGA PACKAGE
 ↓
 BGA SOCKET
 ↓
 Surface Mount
 to PCB

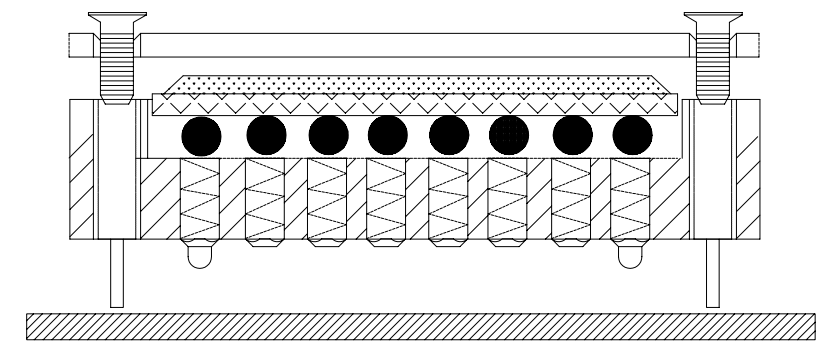

Torque Limiting Screw Driver

- Note: 1. Refer E-Tec document for more information.
 2. Must use torque limiting screw driver to tighten screws (refer Mountz minimaster 020074 gold, preset 7cN.m/10ozf.in). Under torque limit tighten could fail continuity and over torque limit tighten could crack package.
 3. Alignment pins are removable.

Rev.2	Ajout alignment plate+ Ø0.37 au lieu de Ø0.35+changement PCB Layout		L.G 08.09.06
<small>UNLESS OTHERWISE SPECIFIED, DIMENSIONS ARE IN MILLIMETERS. SURFACE FINISH: GENERAL TOLERANCES: ±0.10. LINEAR ANGULAR: "top view drawing"</small>			
Remark:	BGA socket, 729 pins, Pitch 1.27mm, matrix 27x27 Retention frame, Basic system 28x28 *replace version 1		
www.e-tec.com	#/o locating pegs "E-tec code"	BPW144-1028-12AA95	A4V
Scale: 2.8:1	#/o locating pegs "Production code"	BPW0144-10-09345-12AAA	
MATERIAL:	with locating pegs "E-tec code"	BPW144-1028-12AA95L	2
WEIGHT:	with locating pegs "Production code"	BPW0144-10-09345-12AAA-L	REVISION

UNLESS OTHERWISE SPECIFIED DIMENSIONS ARE IN MILLIMETERS DECIMAL X.X ±0.10 X.XX ±0.05 X.XXX ±0.03		ANGULAR ±1°					ACTEL CORPORATION 2061 Stierlin Court Mountain View, CA 94043-4655	
APPROVALS		DATE		TITLE				
DRAWN Lijie Zhao		06/15/2007		SE-FGG144-H, E-Tec lead free prototype socket (raised height) drawing for FG144 and FGG144 packages				
MATERIAL SEE NOTES		CHECKED		VENDOR NAME: E-tec		ACTEL DWG. NUMBER 1-07-11079		REV 0
FINISH SEE NOTES		ENG'R		SIZE B		VENDOR SID(PART) NUMBER BPW144-1028-12AA95L		REV
DO NOT SCALE DRAWING		RELEASED		Actel Part#: SE-FGG144-H		SCALE: NONE		SHEET 1 OF 1

E-TEC PATENTS PENDING

Ball / Land Grid Array Sockets Twist Lock Type



E-tec is now the leading BGA socket manufacturer.

EP patents 0829188, 0897655 US patents 6190181, 6249440 Patented in other countries.

Twist lock sockets are available for any chip size and grid pattern. The SMT socket is simply placed and reflowed onto the PCB in the same way as the chip and occupies only a small amount of additional board space. The 1.27mm pitch screw lock socket extends ≈ 6,00 mm beyond the outer ball row with no fixing holes.

We aim to solve your requirements - many different terminals and configurations are available. Your custom sets our standards!

Please note, we will always request the chip data to ensure we offer a compatible socket.

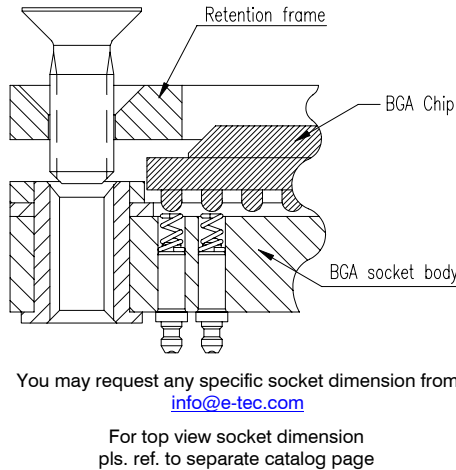
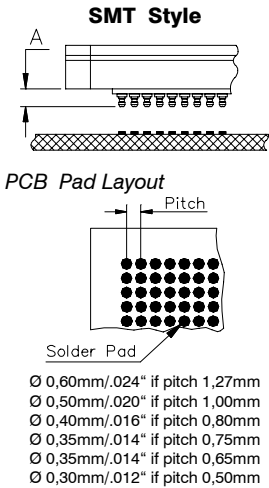
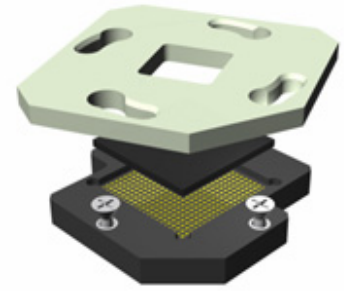

Important Note:

Please check the ball diameters & heights of your chip prior to ordering the standard E-tec BGA (BPW, BCW) sockets. Any deviation has to be communicated to E-tec in order to check compatibility with the standard socket design and if necessary to obtain a special order code adapted to your chip dimensions.

The standard solderball diameters & heights are the following:

Pitch	ball diameters	ball height
	min/max	min/max
0.50mm	0.25mm / 0.35mm	0.15mm / 0.30mm
0.65mm	0.25mm / 0.45mm	0.15mm / 0.30mm
0.75mm	0.25mm / 0.45mm	0.15mm / 0.40mm
0.80mm	0.40mm / 0.55mm	0.25mm / 0.45mm
1.00mm	0.50mm / 0.70mm	0.30mm / 0.50mm

1.27mm & 1.50mm

- a) plastic chips (BPW) 0.60mm / 1.00mm 0.50mm / 0.70mm
- b) ceramic chips (BCW) 0.60mm / 1.00mm 0.80mm / 1.00mm

If the minimum ball diameter of a given chip falls below the above indications, then a BUW socket will generally be proposed.

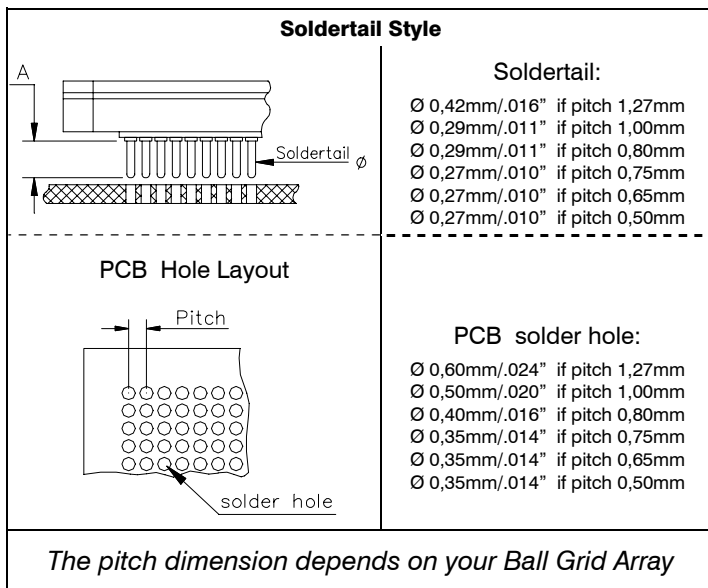

Mechanical data

- Contact life
- Retention System life
- Solderability
- Individual contact force
- Max. torque for retention screws

Specifications

- 10.000 cycles min.
- 1.000 cycles min.
- exceeds MIL-STD-202 Method 208
- 40 grams max.
- up to 800 pins = 7cNm or 10 oz-inch
- as of 800 pins = 7cNm to 10cNm or 10 oz to 14 oz-inch

Material

- Insulator (RoHS compliant)
- Terminal (RoHS compliant)
- Contact (RoHS compliant)

- High temp plastic or epoxy FR4
- Brass
- BeCu

Electrical data

- Contact resistance
- Current rating
- Insulation resistance at 500V DC
- Breakdown voltage at 60 Hz
- Capacitance
- Inductance

- < 100 mΩ
- 500 mA max.
- 100 MΩ if 0.50 to 0.80mm pitch
- 500 MΩ 1.00mm pitch upwards
- 500V min.
- < 1 pF
- < 2 nH

Operating temperature

- 55°C to +125°C ; 260°C for 60 sec.

Recommendations

- Torque limiting screw driver
- Solder paste
- Solder profile

- Refer to page "Tools" of this catalog
- Please use a solder paste w/o any silver!
- Please refer to our website www.e-tec.com

How to order

X X W x x x x - x x x x - x x X X 95 L ← optional for locating pegs

Device Type

B = Ball Grid

L = Land Grid

C = Column Grid

Device Material

C = std. socket for ceramic device

P = std. socket for plastic device

U = socket adapted to small diameter solderballs

Pitch

05 = 0,50mm	10 = 1,00mm
06 = 0,65mm	12 = 1,27mm
07 = 0,75mm	15 = 1,50mm
08 = 0,80mm	others on request

Grid Code | **Config Code**

will be given by the factory after receipt of the chip datasheet

Plating

95 = tin/gold (tin leadfree)

Nbr of contacts

depends on ballcount of chip

Contact Type

30 = standard SMT... („A“ = 1,20mm if 1,27mm pitch; 0,80mm if 1,00mm pitch, 0,60 if 0,80mm pitch; 0,40mm if <0.80mm pitch)
29 = raised SMT.. („A“ = 5,00mm if 1,27mm pitch; 3,20mm if 1,00mm pitch; 2,80mm if 0,80mm pitch, 2,30mm if <0.80mm pitch)
28 = special raised SMT - only for 1.00 & 0.80mm pitch..... („A“ = 4,50mm)
70 = standard solder tail..... („A“ = 3.30 if 1.27mm pitch, 2.80 if 1.00mm or 0.80mm pitch, 2,30mm if <0.80mm pitch)



Socket Mounting Recommendations and Reflow Profile

Purpose

This document is meant to serve as a guide for mounting E-tec surface mount device (SMD) sockets to the printed circuit board (PCB). The recommendations described here are guidelines only, and modifications may be needed for your particular socket, PCB, and process.

Application

The sockets this document applies to are as follows: Clam Shell, Knob Lock, Screw Lock, Twist Lock, Quick Lock and Lever Lock in SMD style. These sockets utilize the E-tec patented spring-pin technology. This technology allows the pins to be soldered to the PCB while still providing compliance to the device under test (DUT) via springs located at the other end of the pin. The pins themselves do not have solder pre-forms as a BGA would with its solder balls. However, the sockets are designed to mount to the same PCB footprint and pads as required by the BGA, or any other IC package the socket was designed for (except if locating pegs are used; see 'Locating Pegs' section of this document). When compared to mounting a BGA, an extra volume of solder paste is required to mount the sockets to the PCB. To effect this, a properly dimensioned stencil is required. Once the paste has been applied, a standard reflow process is then used to solder the socket to the PCB. After the socket is verified to have proper electrical connection to the PCB, the system is then ready to be used.

Locating Pegs

Although designed to mount to the same footprint as the IC, with just a small amount of additional keep-out area, E-tec sockets can also be offered with locating pegs. The sockets are typically mounted with two locating pegs, which require two thru-holes drilled into the PCB. These pegs help to align the socket on the PCB, and hence align the socket's pins to the PCB's pads, during the soldering process. Furthermore, plating the thru-holes allows the locating pegs to be soldered to the PCB for better mechanical stability during everyday use and handling of the socket. If the PCB design permits, E-tec recommends the use of these locating pegs. For fine-pitch, low pin-count sockets without locating pegs, the mechanical strength of the solder joints may be insufficient. In these cases, it is recommended to epoxy the socket body to the PCB. 3M Scotch-Weld 2216 B/A is a suitable epoxy. In any case, the proper volume of solder paste is required to ensure mechanical and electrical integrity. Recommended stencil dimensions are given in the next section of this document.



Socket Mounting Recommendations and Reflow Profile

Stencil

Table 1 shows the recommended stencil dimensions. A laser-cut, electro-polished and Ni-plated stainless steel stencil is recommended to give the most consistent paste release. The apertures can be made round except for smaller pitches, where square apertures are recommended.

Remember to keep the stencil small enough to fit within the keep-out area of the socket, but yet have provisions to remove it from the PCB once the paste has been applied.

Table 1: Recommended stencil dimensions.

Device Pitch (mm)	PCB Pad Diameter (mm / in)	Stencil Thickness (mm/in)	Stencil Aperture (mm/in)
1.27	min. 0.60 / 0.023	0.15 / 0.006	round 0.66 / 0.026
1.00	min. 0.50 / 0.019	0.15 / 0.006	round 0.55 / 0.022
0.80	min. 0.40 / 0.016	0.13 / 0.005	round 0.44 / 0.017
0.75	min. 0.35 / 0.014	0.13 / 0.005	square 0.39 / 0.015
0.65	min. 0.35 / 0.014	0.13 / 0.005	square 0.39 / 0.015
0.50	min. 0.30 / 0.012	0.13 / 0.005	square 0.33 / 0.013

Solder Paste

E-tec recommends using solder paste without (or <0.5%) silver (Ag) to reduce the solder's wetting ability and prevent the paste from running up the pins, thus maximizing the volume of solder left on the pads. Brands such as Qualitek (www.qualitek.com) or Alpha Metals (www.alphametals.com) produce such solder paste on customer request. For Sn/Pb solder paste we recommend Ecorel 803S offered by Avantec (www.avantec.dehon.com).

Reflow Profile

Both standard Sn-Pb eutectic and Pb-free reflow profiles are shown below.

Table 4-1 SnPb Eutectic Process – Package Peak Reflow Temperatures

Package Thickness	Volume mm ³ <350	Volume mm ³ ≥ 350
<2.5 mm	240 +0/-5 °C	225 +0/-5 °C
≥ 2.5 mm	225 +0/-5 °C	225 +0/-5 °C

Table 4-2 Pb-free Process – Package Classification Reflow Temperatures

Package Thickness	Volume mm ³ <350	Volume mm ³ 350 - 2000	Volume mm ³ >2000
<1.6 mm	260 +0 °C *	260 +0 °C *	260 +0 °C *
1.6 mm - 2.5 mm	260 +0 °C *	250 +0 °C *	245 +0 °C *
≥2.5 mm	250 +0 °C *	245 +0 °C *	245 +0 °C *

* Tolerance: The device manufacturer/supplier shall assure process compatibility up to and including the stated classification temperature (this means Peak reflow temperature +0 °C. For example 260 °C+0°C) at the rated MSL level.

Note 1: The profiling tolerance is + 0 °C, -X °C (based on machine variation capability) whatever is required to control the profile process but at no time will it exceed - 5 °C. The producer assures process compatibility at the peak reflow profile temperatures defined in Table 4.2.

Note 2: Package volume excludes external terminals (balls, bumps, lands, leads) and/or nonintegral heat sinks.

Note 3: The maximum component temperature reached during reflow depends on package thickness and volume. The use of convection reflow processes reduces the thermal gradients between packages. However, thermal gradients due to differences in thermal mass of SMD packages may still exist.

Note 4: Components intended for use in a "lead-free" assembly process shall be evaluated using the "lead free" classification temperatures and profiles defined in Tables 4-1, 4.2 and 5-2 whether or not lead free.

E-tec Interconnect Ltd, Industrial Zone C, CH-1072 Forel (Lavaux), Switzerland

Phone +41-21-781 08 10 · www.e-tec.com · info@e-tec.com

Socket Mounting Recommendations and Reflow Profile

Table 5-2 Classification Reflow Profiles

Profile Feature	Sn-Pb Eutectic Assembly	Pb-Free Assembly
Average Ramp-Up Rate ($T_{S_{max}}$ to T_p)	3 °C/second max.	3° C/second max.
Preheat – Temperature Min ($T_{S_{min}}$) – Temperature Max ($T_{S_{max}}$) – Time ($t_{S_{min}}$ to $t_{S_{max}}$)	100 °C 150 °C 60-120 seconds	150 °C 200 °C 60-180 seconds
Time maintained above: – Temperature (T_L) – Time (t_L)	183 °C 60-150 seconds	217 °C 60-150 seconds
Peak/Classification Temperature (T_p)	See Table 4.1	See Table 4.2
Time within 5 °C of actual Peak Temperature (t_p)	10-30 seconds	20-40 seconds
Ramp-Down Rate	6 °C/second max.	6 °C/second max.
Time 25 °C to Peak Temperature	6 minutes max.	8 minutes max.

Note 1: All temperatures refer to topside of the package, measured on the package body surface.

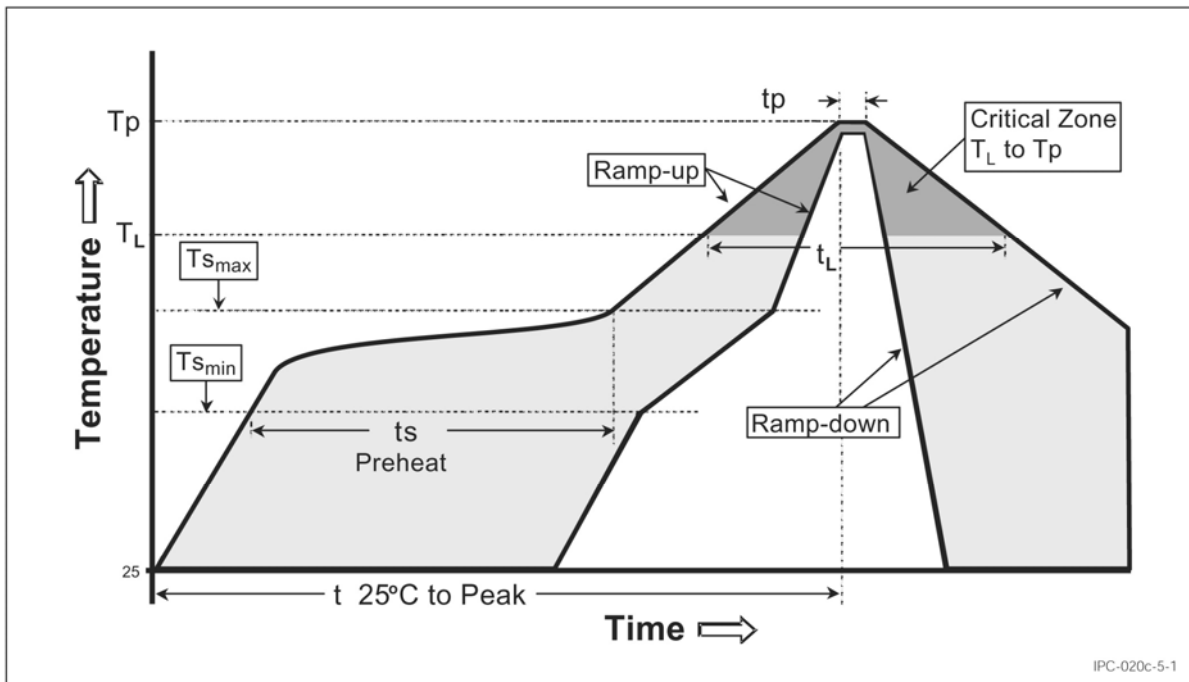

Figure 5-1 Classification Reflow Profile



Socket Mounting Recommendations and Reflow Profile

Verifying the Assembly

After the socket has been reflowed to the PCB, open and short testing should be partaken to ensure proper assembly. The assembly house typically performs x-ray inspection to verify non-shortening of pins. However, as this is only a visual inspection, we recommend using a continuity tester or ohmmeter and simply sweeping random rows and columns of pins to ensure no shorting of pins. No damage to the springs will occur if very slight pressure from the meter's tips is applied (just touch the probes to the springs). For fine pitch sockets, a microscope would be helpful in placing the meter's tips appropriately.

After verifying the absence of shorts, open testing should be performed. The most direct, yet tedious, method is to use the continuity tester to directly probe each pin to a breakout or test point on the board. Again no damage will occur if the probes are touched to the springs. If heavy pressure is required to push the socket body towards the PCB to achieve continuity, this means a poor solder joint. If no such test points exist, then the BGA's via field on the backside of the PCB should be kept solder-mask free to allow for such probing. If the via field is kept open, a simpler open testing method can be performed. Simply use a wet sponge (or some other conductive material) and hold it onto the via field. This shorts all the pins together on the PCB. Insert one probe of the continuity tester into the sponge. Now sweep the pins of the socket with the other probe and check for continuity.

If the above procedures show any shorts or opens, then it is advisable to have the assembly house re-evaluate the assembly method used. An incorrect stencil can lead to too much or too little solder paste, easily leading short or open conditions and a solder paste with Ag contents ($\geq 0.5\%$) may also result in solder joint failures. These are the primary reasons for socket mounting failures.

Important Notes:

a) Screw/Twist Lock Socket

When tightening the lid of a Screw or Twist Lock socket, it is imperative to not over-tighten the retention screws, otherwise irreparable damage may occur. Such damage is not covered by warranty and will be solely the end user's responsibility. The maximum allowed torque on these retention screws is 7cN-m (10oz-in) for sockets up to 800 pins and for sockets as of 800 pins the torque value needs to be increased but should not exceed a maximum of 10cN-m (14oz-in). E-tec sells the torque screwdriver TOL-7CN-TORQUE which is preset to 7cN-m, but which can be adjusted to higher torque values for the high pin count sockets.



Socket Mounting Recommendations and Reflow Profile

b) Knob Lock / Quick Lock / Clamshell Socket

It is recommended to remove the Knob Lock, Quick Lock and Clamshell retainer from the socket base prior to soldering the sockets to the PCB. This will avoid socket displacement during the soldering process due to the weight of these retainers. User instructions on how to remove and reassemble the Clamshell retainer from the socket base can be obtained from E-tec.

c) Pick & Place Pads

Pick & place pad options can be obtained on request for all SMT sockets. If required, please contact E-tec prior to placing a purchase order, since such pick & place pad options may require special fixtures on the socket base which are not included in the standard socket design.

TLS

Torque Screwdrivers Limiting, Internally Adjustable

Designed and manufactured to meet or exceed the accuracy and repeatability requirements of ISO 6789:1992.

Various models that range from 0.7 ozf.in to 120 lbf.in.

Precision radial ball clutch "slips-free" when the preset torque is reached preventing overtorquing.

Thrust bearings insure that the torque setting is independent of any end load applied by the operator.

Tamper-proof internal adjustment.

All models provide bi-directional operation. Available with a one-way clutch system so the screwdriver will operate in one direction but lock solid in the opposite direction for easy screw removal.

Can be clean room modified upon request.

Four different colored lightweight aluminum handles allow color coding of specific torque values in production areas.



Model	1/4" MALE SQUARE DRIVES		1/4" FEMALE HEX DRIVES		Presettable Torque Ranges			Weight	
	Item#	Color	Item#	Color	American	S.I.	Metric	oz.	g.
Micro Minimaster	-	-	020083	Red	3 - 32 ozf.in	2 - 22 cN.m	216 - 2300 gf.cm	1.8	50
Minimaster	-	-	020074	Gold	0.7 - 32 ozf.in	0.5 - 22 cN.m	50 - 2306.2 gf.cm	2.5	72
Minor	020062	Blue	020066	Blue	3 ozf.in - 12 lbf.in	2 - 135 cN.m	200 gf.cm - 14 kgf.cm	7.4	210
	020063	Gold	020067	Gold					
	020064	Green	020068	Green					
	020065	Red	020069	Red					
Standard	020075	Blue	020079	Blue	8 ozf.in - 36 lbf.in	6 - 406 cN.m	600 gf.cm - 40 kgf.cm	9.9	280
	020076	Gold	020080	Gold					
	020077	Green	020081	Green					
	020078	Red	020082	Red					
TLS 1360	020060	Black	020061	Black	10 - 120 lbf.in	113 - 1360 cN.m	11 - 138 kgf.cm	11.5	325