

AK7844**Stereo Audio Class-D Amp with Power Booster for Piezo Speakers****GENERAL DESCRIPTION**

THE AK7844 is Stereo Class-D amplifier for driving Piezo-Electric Speakers. Built-in Boost DCDC converter generates adequate high voltage for driving Piezo Speakers from Li-Ion battery.

AKM state-of-the-art filter-less solution eliminates LC-filters, which are normally required at Class-D outputs. That contributes to total space saving.

Class-D operation ensures higher power efficiency, and couple with Piezo Speaker that is low-power-consumption and low-profile figure. The AK7844 is very applicable for cellular phones with piezo speakers.

FEATURES**□ Class-D Amplifier :**

- Piezo-Electric Speaker Driver
- Single-ended analog Input
- BTL output
- Output voltage = 8Vrms @VDD1=8.75V
- Filter-less solution
- Stereo mode
- Pop noise suppressor
- Output short protection

□ Boost DCDC Converter :

- Input voltage (Battery) = 2.7V ~ 4.5V → Boosted voltage will be 8.75V
- Over-current protection
- Over-voltage protection

□ Control function :

- Pre-gain amplifier -6dB ~ +15dB, 3dB step * Adjustable by Pin (PG0, PG1 and PG2) control
- Built-in Second order lowpass filter at Input.
- Cutoff Frequency (4kHz, 8kHz, 16kHz) * Adjustable by Pin (PG0, PG1 and PG2) control
- Power-on/off control
- Over-temperature protection

□ Operational voltage : VBAT=2.7V ~ 4.5V、DVDDI=1.65V ~ 4.5V

□ Operational temperature : -30°C ~ 85°C

□ Package : 31pin WL-CSP (3.0mm × 3.0mm, 0.5mm pitch)

BLOCK DIAGRAM

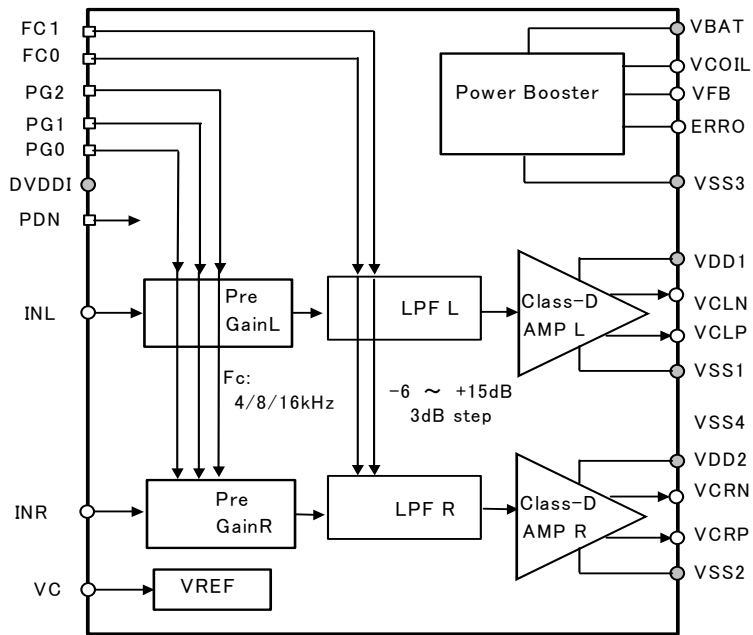
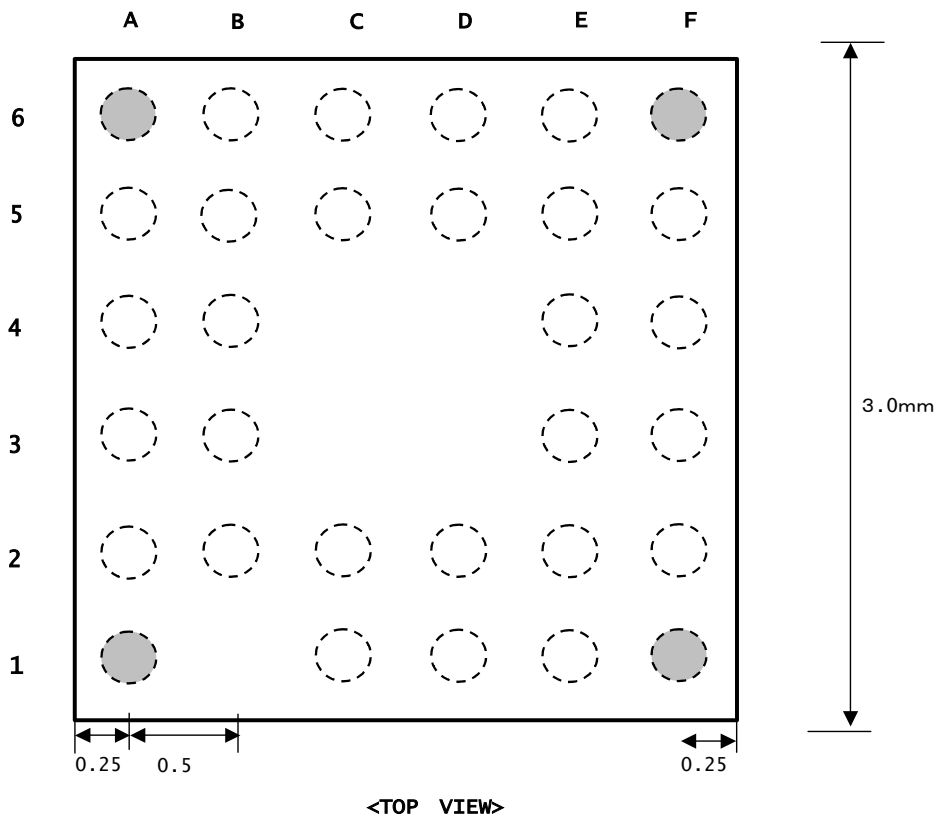

Figure 1. BLOCK DIAGRAM

PIN ASSIGNMENT



-	A	B	C	D	E	F
6	NC	VDD2	VFB	NC	VDD1	NC
5	VCRP	VCRN	NC	NC	VCLN	VCLP
4	ERRO	VSS2	—	—	VSS1	INL
3	PG2	VSS4	—	—	VBAT	INR
2	VCOIL	VSS3	PG1	FC1	FC0	VC
1	NC	<Index>	PG0	DVDDI	PDN	NC

Figure 2. Pin Assignment

Pin / FUNCTION

No.	Pin Name	I/O	Function
A1	NC	—	No Connection pin. Connect to ground.
A2	VCOIL	—	Inductor pin for Boost DCDC.
A3	PG2	I	Pre Gain setting pin2 (available when I2CEN="L")
A4	ERRO		Phase compensation capacitor connection pin for Boost DCDC. Connect a 0.1 μ F capacitor between VC pin and ground.
A5	VCRP	O	Right channel Class D amp plus output (+)
A6	NC		No Connection pin. Connect to ground.
B1	—	—	<Index>
B2	VSS3	—	Power Booster ground pin : VSS3=0V
B3	VSS4		Internal analog circuit ground pin : VSS4=0V
B4	VSS2	I	Right channel Class D amp ground pin : VSS2=0V
B5	VCRN	O	Right channel Class D amp minus output (-)
B6	VDD2		Right channel Class D amp power supply : VDD2=8.75V(typ.)
C1	PG0	I	Pre Gain setting pin0
C2	PG1	I	Pre Gain setting pin1
C3	—	—	—
C4	—	—	—
C5	NC		No Connection pin. Connect to ground.
C6	VFB		Boosted voltage feedback pin.
D1	DVDDI		Digital interface power : DVDDI=1.65V~4.5V
D2	FC1	I	SCF cutoff frequency setting pin1
D3	—	—	—
D4	—	—	—
D5	NC		No Connection pin. Connect to ground.
D6	NC		No Connection pin. Connect to ground.
E1	PDN	I	Power down control : schmitt trigger input "High" : power up, "Low" : power down
E2	FC0	I	SCF cutoff frequency setting pin2
E3	VBAT	—	Battery voltage input : VBAT=2.7V~4.5V
E4	VSS1	—	Left channel Class D amp ground pin : VSS1=0V
E5	VCLN	O	Left channel Class D amp minus output (-)
E6	VDD1		Left channel Class D amp power supply : VDD1=8.75V(typ.)
F1	NC		No Connection pin. Connect to ground.
F2	VC		Voltage reference output. Connect a 0.01 μ F capacitor between VC pin and ground.
F3	INR	I	Right channel analog signal input
F4	INL	I	Left channel analog signal input
F5	VCLP	O	Left channel Class D amp plus output (+)
F6	NC		No Connection pin. Connect to ground.

Note 1. Digital input pins (PDN, PG2, PG1, PG0, FC1, FC0) must not be open.

■ Unused Pins

Unused pins should be configured as below.

Category	Pin Name	Configuration
NoConnection	NC	GND

ABSOLUTE MAXIMUM RATINGS

(VSS1, VSS2, VSS3, VSS4=0V; Note 3)

Parameter	Symbol	min	max	Units	
Power Supplies: (Note.4)	Battery	VBAT	-0.3	6.5	V
	Digital I/F	DVDDI	-0.3	6.5	V
	Class-D Amp	VDD1,2	-0.3	15	V
Input Current, Any Pin Except Supplies	IIN	-10	+10	mA	
Analog Input Voltage (Note 4) (Note 6)	VINA	-0.3	VBAT+0.3	V	
Digital Input Voltage (Note 5) (Note 6)	VIND	-0.3	DVDDI+0.3	V	
Ambient Temperature (powered applied)	Ta	-30	85	°C	
Storage Temperature	Tstg	-65	150	°C	

Note 2. All voltages are with respect to ground.

Note 3. VSS1, VSS2, VSS3, VSS4 pin must be connected to the same analog ground plane.

Note 4. INL, INR pin

Note 5. PDN, PG2, PG1, PG0, FC1, FC0 pin

Note 6. Maximum value must not exceed 6.5V even if VBAT or DVDDI is more than 6.2V.

WARNING: Operation at or beyond these limits may result in permanent damage to the device.
Normal operation is not guaranteed at these extremes.

RECOMMENDED OPERATING CONDITIONS

(VSS1, VSS2, VSS3, VSS4=0V; Note 2)

Parameter	Symbol	min	typ	max	Units	
Power Supplies	Battery (Note 7)	VBAT	2.7	3.6	4.5	V
	VDD (Note 8)	VDDx	TBD	8.75	TBD	V
	Digital I/F (Note 7)	DVDDI	1.65	2.8	4.5	V

Note 2. All voltages are with respect to ground.

Note 7. Should sustain "VBAT ≥ DVDDI" condition

Note 8. Supply with boosted voltage (typ. 8.75V) by the Power Booster.

* AKM assumes no responsibility for usage beyond the conditions in this datasheet.

DC CHARACTERISTICS

(Ta=25°C; VBAT=2.7 ~ 4.5V, DVDDI = 1.65~4.5V, VSS1=VSS2=VSS3=VSS4=0V)

Parameter	Symbol	min	typ	max	Units
High-Level Input Voltage1 (Note 9)	VIH1	70%DVDDI	-	-	V
Low-Level Input Voltage1 (Note 9)	VIL1	-	-	30%DVDDI	V
High-Level Input Voltage2 (Note 10)	VIH2	80%DVDDI	-	-	V
Low-Level Input Voltage2 (Note 10)	VIL2	-	-	20%DVDDI	V
Input Leakage Current				±10	μA

Note 9. Applied to PG0, PG1, PG2.

Note 10. Applied to PDN, FC1, FC2 (Summit trigger input).

ANALOG CHARACTERISTICS

(Unless otherwise noted, Ta=25°C, VBAT=3.6V, DVDDI=2.8V, VSS1,2,3,4=0V, Input Signal Frequency =1kHz, Measurement Band Width =20~20kHz, PreGain=0dB, Fc= 16kHz Class-D ampu Output Load Impedance Z_L=1.0uF)

Parameter	Condition	min	typ	max	Units
I _{dd}	No input signal. With output Load		T.B.D		mA
ShutdownCurrent	PDN pin = "Low"		1.0	10	μA
Input Impedance	INL	25	50	75	kΩ
	INR	25	50	75	kΩ
PreGain Control Range		-6		+15	dB
PreGain Step Size (Note 11)	PG2="Low",PG1=" Low",PG0=" Low"	-7	-6	-5	dB
	PG2="Low",PG1=" Low",PG0=" High"	-4	-3	-2	dB
	PG2="Low",PG1=" High",PG0=" Low"	-1	0	+1	dB
	PG2="Low",PG1=" High",PG0=" High"	+2	+3	+4	dB
	PG2=" High",PG1=" Low",PG0=" Low"	+5	+6	+7	dB
	PG2=" High",PG1=" Low",PG0=" High"	+8	+9	+10	dB
	PG2=" High",PG1=" High",PG0=" Low"	+11	+12	+13	dB
	PG2=" High",PG1=" High",PG0=" High"	+14	+15	+16	dB
Output Voltage	VCL(R)P/VCL(R)N Input Signal=0.7Vrms	TBD	5.0	TBD	Vrms
Output Offset Voltage	VCL(R)P/VCL(R)N No input signal	-	-	T.B.D.	mV
THD+N	VCL(R)P/VCL(R)N (Note 12) Input Signal=0.5Vrms	-	-	-30	dB
SNR	VCL(R)P/VCL(R)N (Note 12) Input Signal=0.7Vrms using an A wating filter.	70	80	-	dB
PSRR (Note 13)	VCL(R)P/VCL(R)N (Note 12) Vripple=200mVpp@1kHz sinwave		50		
Cross Talk	INL : NoInput、INR=2Vpp Lch: OutputPin monitoring.		70		dB
	INR : NoInput、INL=2Vpp Rch: OutputPin monitoring.		70		dB
Switching Frequency	Class-D Amp	225	250	275	kHz
	PowerBooster	900	1000	1100	
Startup Time (Note 14)	C3=0.01uF, C5=C6= 0.1uF(Note 15) VBAT=2.7V		28		ms

Note 11. Setting accuracy of each setting is within ±1dB. Monotony is guaranteed.

Note 12. Measure signals between VCL(R)N and VC L(R)P through Low-Pass-Filter (fc=20kHz).

Note 13. 200mVpp@1kHz superimposed signal at VBAT pin, .and measured output.

Note 14. Time period from "PDN" turns "High" to stability operation.

Note 15. Refer to section "TYPICAL APPLICATION CIRCUIT".

OPERATION OVERVIEW

■ Power Control

Once PDN pin is set to “Low”, all circuit will stop and AK7844 will shut down. It resumes and outputs stable signal in (TBD)ms after PDN is set to “High”.

Power-Up Sequence

VBAT and DVDDI must be turned on as (1) or (2) below.

(1) VBAT=DVDDI=“ON” at the same time.

(2) VBAT=“ON” first, then DVDDI=“ON”.

Set PDN pin to “High” when power-on. Then, PDN must be delayed at least 1us after DVDDI is set to High. Do not do them simultaneously.

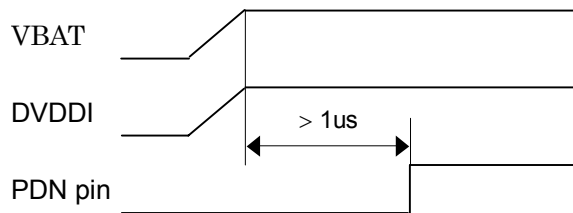

Figure 3. Power-Up Sequence (1) Timing Diagram

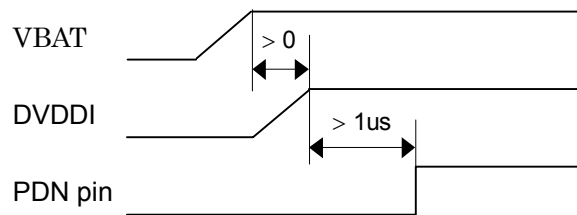

Figure 4. Power-Up Sequence (2) Timing Diagram

Attention: The performance of the device will not be guaranteed after the below sequence.

(3) DVDDI=“ON” first, then VBAT=“ON”.

Power-Down Sequence

VBAT and DVDDI must be turned off as (4) or (5) below.

- (4) VBAT=DVDDI="OFF" at the same time.
- (5) DVDDI="OFF" first, then VBAT="OFF".

Set PDN pin to "Low" when shutdown. Then, 1μs wait is necessary before stopping power supply, DVDDI and VBAT. Do not do them simultaneously.

Note: When PDN pin is "High" and VBAT/DVDDI supply is suddenly cut off due to unexpected event, pop noise may be detected while sound signal is being amplified. Under such cases LSI will not be harmed.

Power supply (VBAT, DVDDI) sequences are as follows.

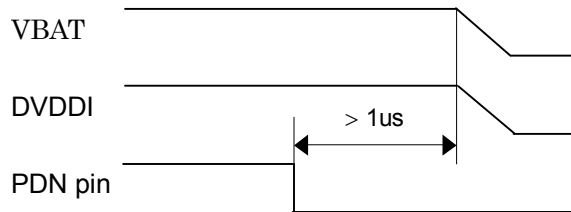

Figure 5. Power-Down Sequence (4) Timing Diagram

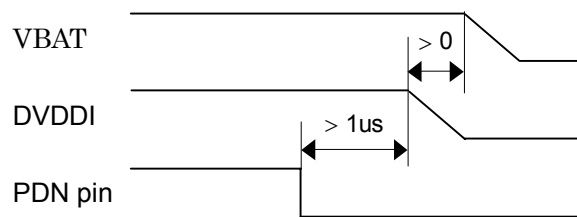

Figure 6. Power-Down Sequence (5) Timing Diagram

Attention: The performance of the device will not be guaranteed after the below sequence.

- (6) VBAT="OFF" first, then DVDDI="OFF"

■ Analog inputs

AC-coupling capacitor is required at analog inputs. Recommended capacitance is 0.1 μ F. This AC-coupling capacitance configures High-Pass-Filter, and used to configuration of POP NOISE SUPPRESSOR as well. Therefore, any variation of this capacitance affects both HPF cut-off frequency and POP NOISE SUPPRESSOR operation.

Additional input filter is applicable. When using filter at analog input, place it before AC-coupling capacitors.

Note 16. Cut off frequency (fc) of the High-pass filter, used as decoupling before input, is calculated by an equation, $1 / (2 \times \pi \times R \times C)$. For example, when Input impedance of INN and INP pins are 50k Ω (typ.) and AC coupling capacitors are 0.1 μ F, then the cut off frequency will be 31.8Hz.

■ Pre AMP

THE AK7844 has internal Pre-Amplifier, which supports from -6dB to +15dB(3dB/step) gain range. Pre-Amplifier gain is adjusted by PG0,PG1 and PG2 like as shown below.

PG2	PG1	PG0	Pre Gain Setting Value
"Low"	"Low"	"Low"	-6dB
"Low"	"Low"	"High"	-3dB
"Low"	"High"	"Low"	0dB
"Low"	"High"	"High"	+3dB
"High"	"Low"	"Low"	+6dB
"High"	"Low"	"High"	+9dB
"High"	"High"	"Low"	+12dB
"High"	"High"	"High"	+15dB

Table. 1 Pre Gain Setting

■ Class-D AMP

Class-D architecture features higher efficiency and low power consumption operation. AKM filter-less solution offers Class-AB performance with Class-D efficiency and minimal board space.

■ Pop Noise Suppressor

The AK7844 features extensive pop noise suppression circuitry.

■ Power Booster

Built-in BOOST DCDC CONVERTER generates adequate high voltage for Piezo-Speaker. Input voltage range corresponds with Li-Ion battery voltage range (2.7V ~ 4.5V), and output voltage is 8.75V. Normally, output connected to and supply VDD1 and VDD2 for Class-D operation.

■ Lowpass Filter

The AK7844 has a built-in Lowpass Filter at the input side. Cutoff frequency can be adjusted by FC0 and FC1 as follows. FC0 and FC1 must be connected to either ground (VSS4) or DVDDI.

FC1	FC0	CurOff Frequency
"Low"	"Low"	16kHz
"Low"	"High"	8kHz
"High"	"Low"	4kHz
"High"	"High"	4kHz

Table. 2 Adjustable Cutoff Frequency of Lowpass filter

■ Protection

The AK7844 supports following protection circuits for protecting against any damages.

Output Short-Circuit Protection

In case of detecting VCL(R)P and VCL(R)N short, the AK7844 clamps peak current of Class-D output circuit without shutting down the outputs.

Over-Temperature Protection

The AK7844 is designed to shutdown at +150°C of inside temperature so that it can be protected from heat damage. Note that the AK7844 DOES NOT support resume function from Over-Temperature Protection. Once it is activated, the AK7844 does not back in normal operation unless "PDN" is toggled ("L" → "H").

Over-Current Protection

Class-D amplifiers' current-limiting protection clamps the output current without shutting down the outputs.

Over-Voltage Protection

Boost DCDC Converter has the voltage-limiting function to avoid destroying itself.

Performance characteristics

※ The following various characteristics are typical characteristic data in the typical condition. It is not the one necessarily to secure the characteristic of the description.

Sinwave Single Input, Total Gain=16.9dB, Measurement Band Frequency=20~20kHz,
Cutoff Frequency=16kHz, unless otherwise specified.

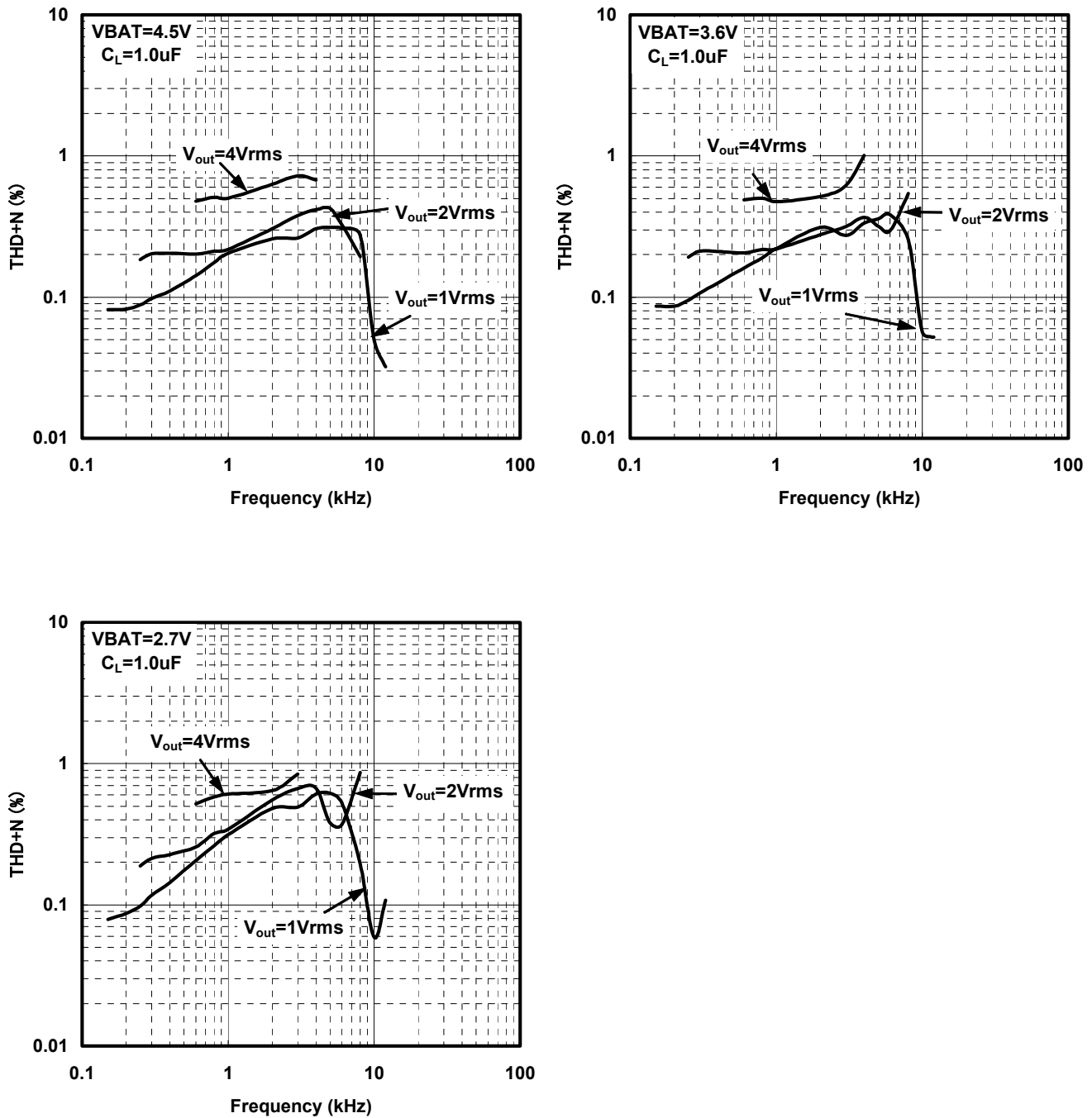

Figure 7. Total Harmonic Distortion Plus Noise vs. Frequency

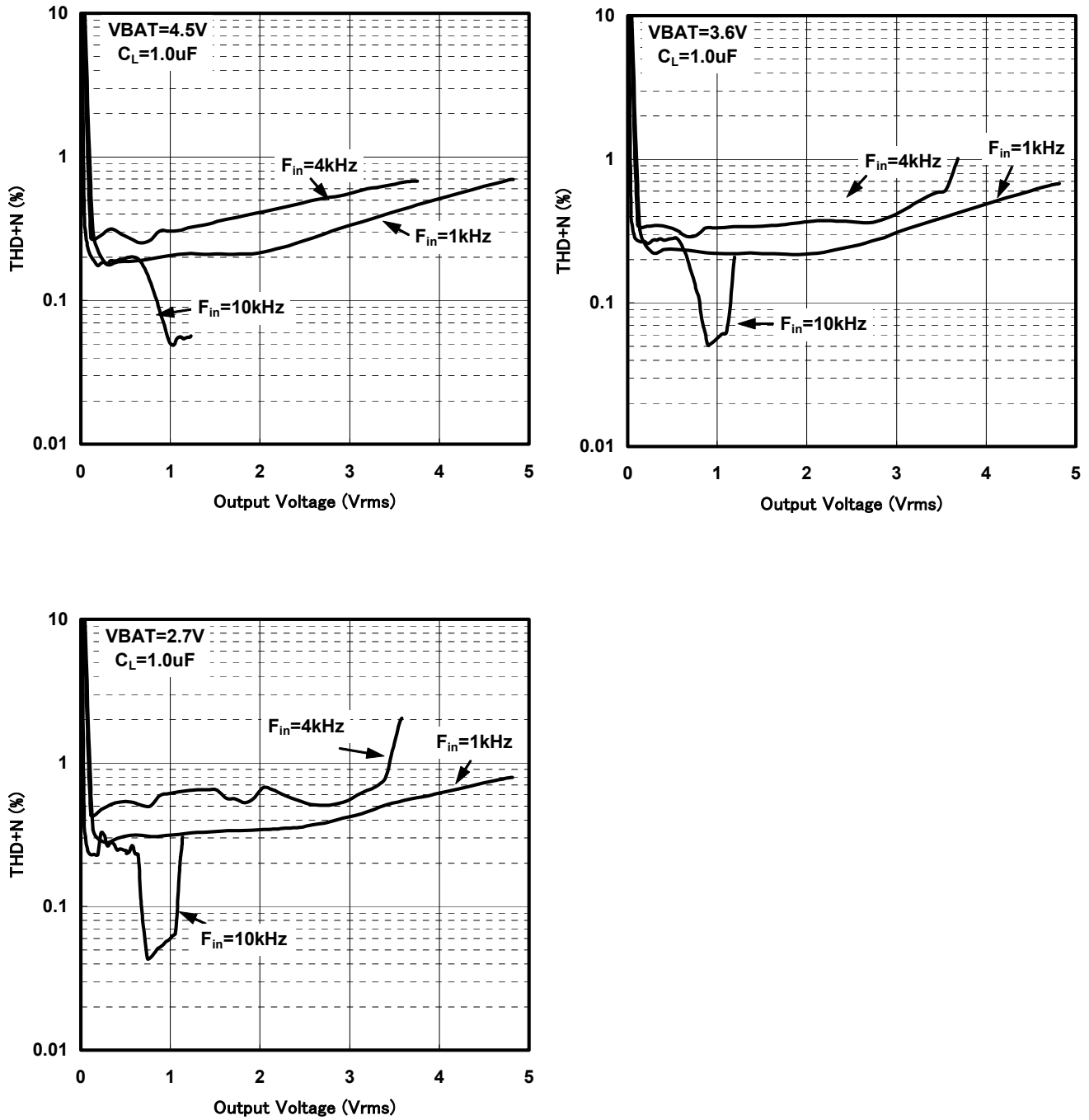

Figure 8. Total Harmonic Distortion Plus Noise vs. Output Voltage

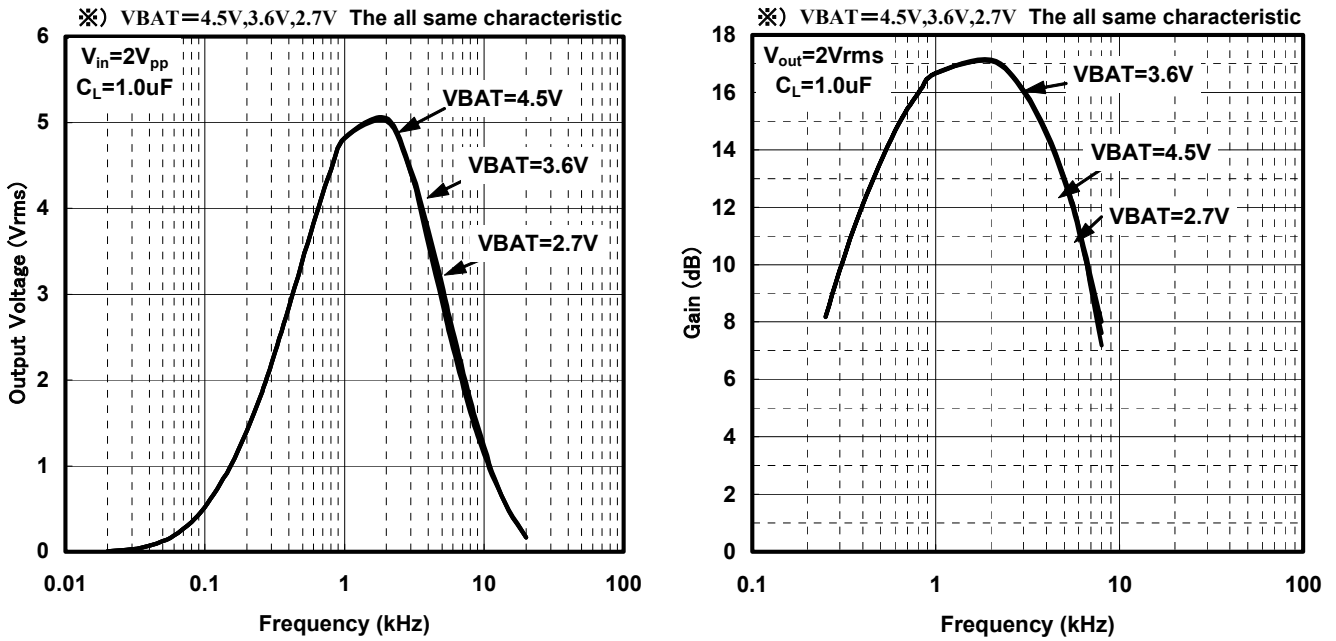

Figure 9. " Output Amplitude vs. Frequency " & " Frequency Response "

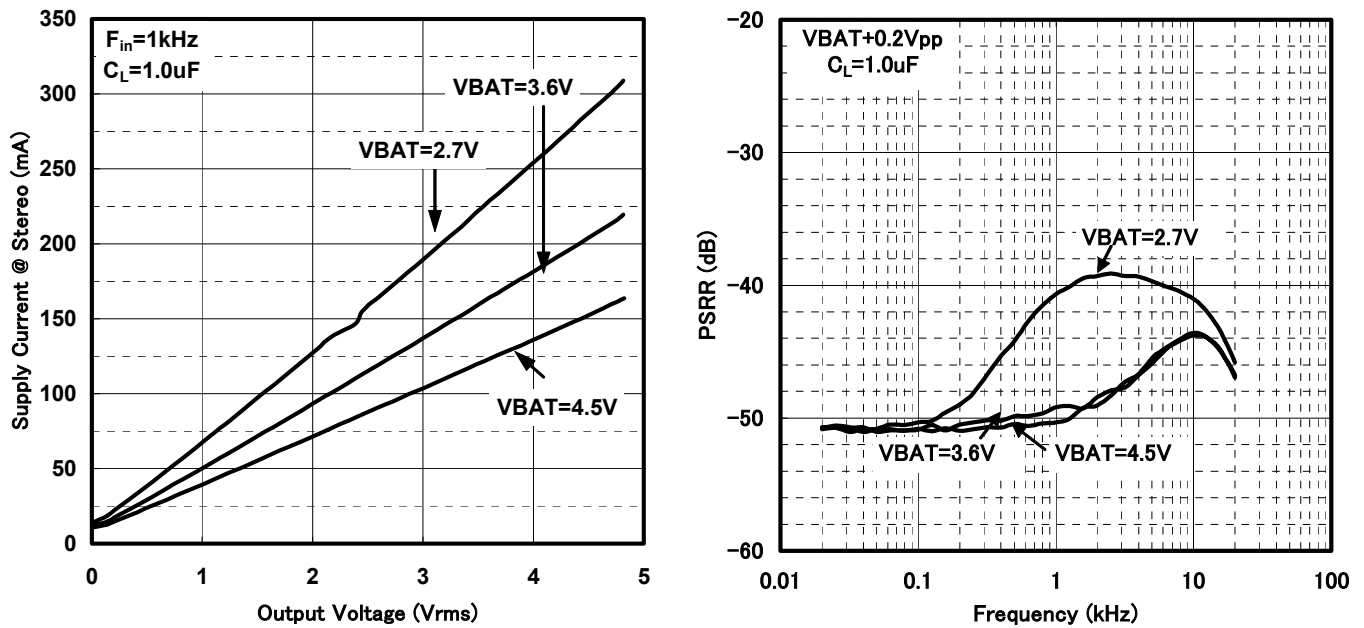

Figure 10. " Supply Current vs. Output Voltage " & " Supply Ripple Rejection Ratio vs Frequency "

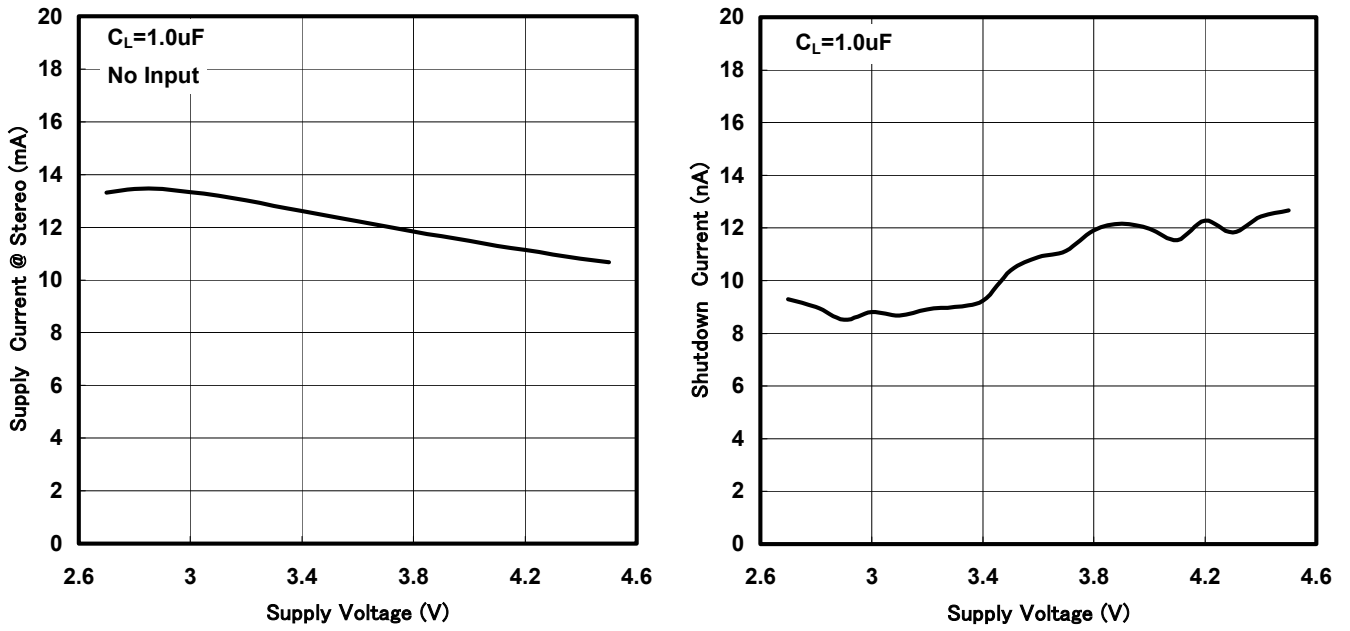

Figure 11. "Supply Current vs. Supply Voltage" & "Shutdown Current vs. Supply Voltage"

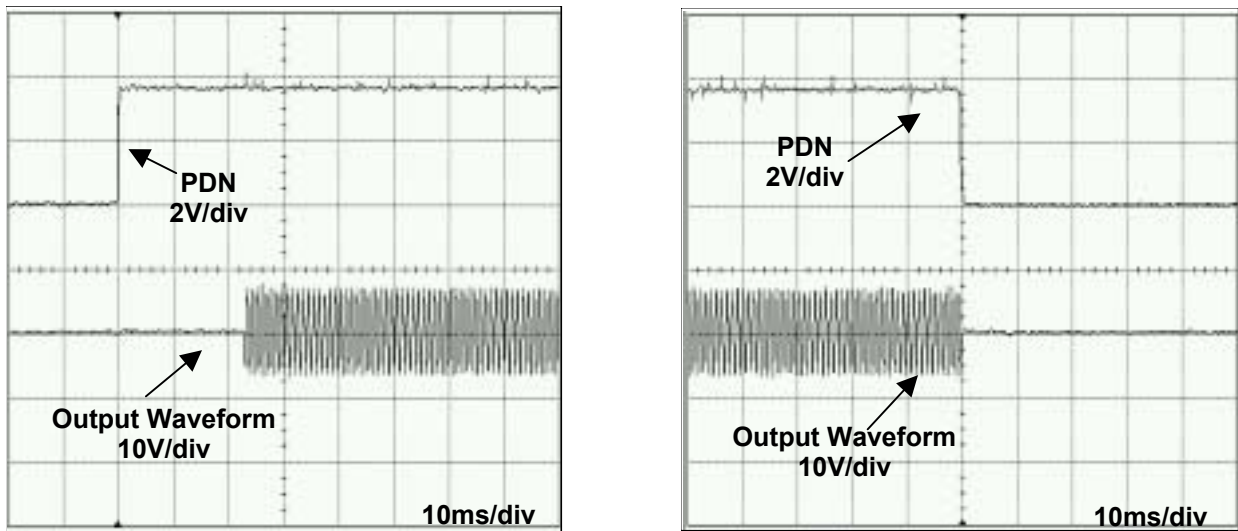

Figure 12. "Startup Waveform" & "Shutdown Waveform"

Power Supply Input : 217Hz Duty 12%
Input pin : AC open
C_L=1.0uF

Power Supply Input : 217Hz Duty 12%
Input pin : AC open
C_L=1.0uF

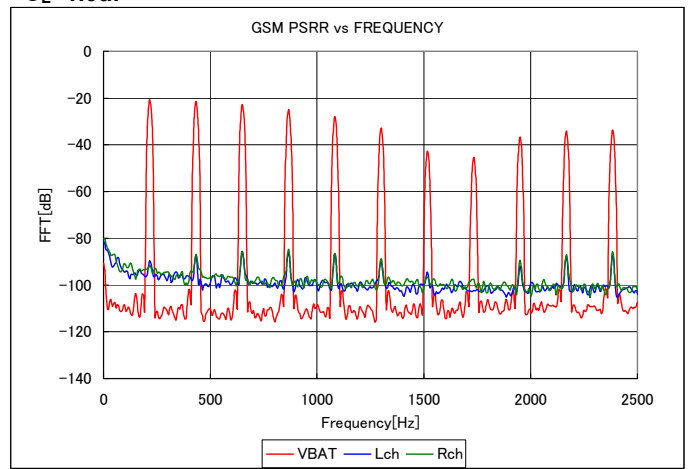
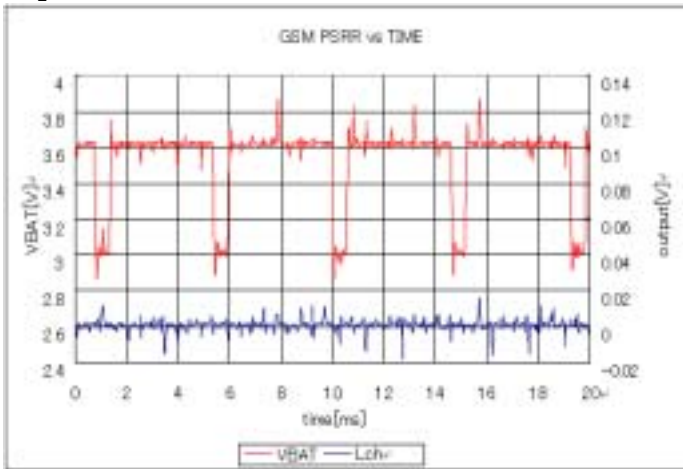

Figure 13. "GSM PSRR vs TIME" & "GSM PSRR vs Frequency"

LEVEL DIAGRAM

The gain of AK7844 are determined by Pre-Amplifier, LPF and Class-D Amp, Total gain will be +16.9dB while Pre-Amplifier is default setting (PG=0). LPF gain and Class-D Amp gain are not changeable. Figure 14 shows level diagram of two example, PG=0dB and PG=+15dB.

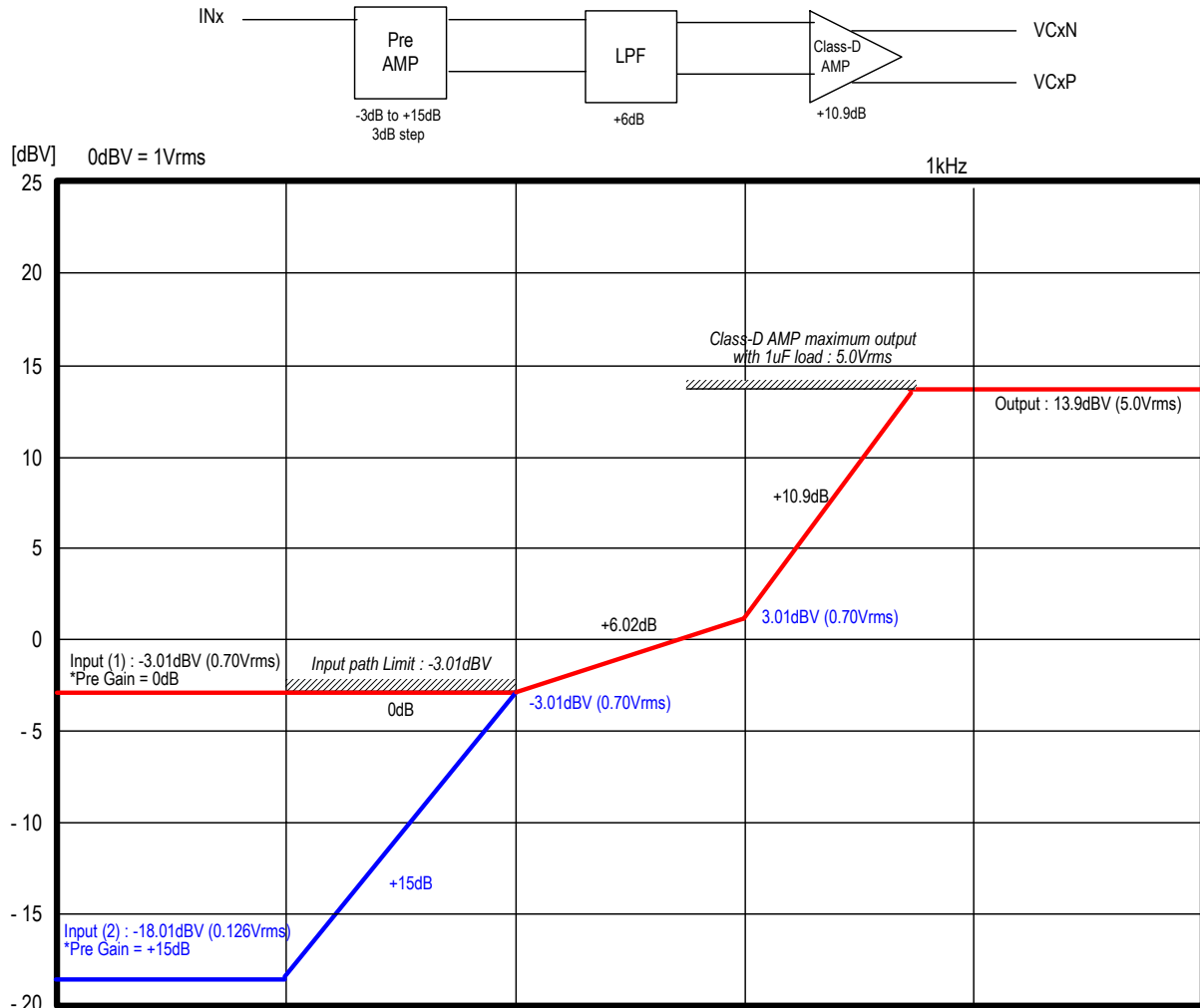

Figure 14. Level Diagram

*1Vrms=0dBV=2.83Vpp (sin wave)

TYPICAL APPLICATION CIRCUIT

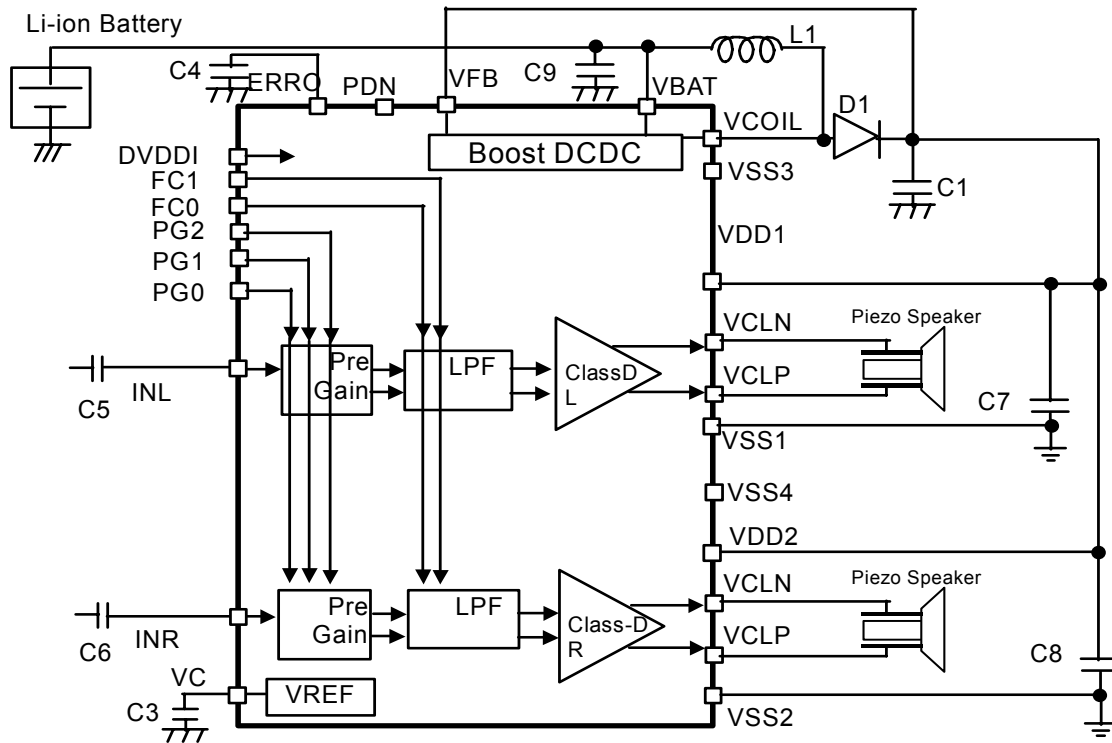

Figure 15 AK7844 Application Schematic

Recommended external components are shown in Table. 3.

Reference	Type	Value	Manufacturer	Part No.	Size (mm)
L1	Inductor ※	1.0uF	CoilCraft	LPS3010-102ML	2.95 × 2.95 × 0.9
			TDK	TFC252008MC-1R0	2.5 × 2.0 × 0.8
D1	Diode / Schottky	(30V, 1A)	SANYO	SS1003EJ	1.6 × 0.8 × 0.6
C1	Capacitor / Ceramic	10μF / 25V	Murata	GRM319B31C106K	3.2 × 1.6 × 0.85
C3	Capacitor / Ceramic	0.01μF / 16V	Murata	GRM155B11E103KA01D	1005 × 0.50
C4, C5, C6, C7, C8	Capacitor / Ceramic	0.1μF / 16V	Murata	GRM155B11A104KA01D	1005 × 0.50
C9	Capacitor / Ceramic	0.1μF / 25V	Murata	GRM188B31A225KE33D	1608 × 0.80

Table. 3 External Recommendation Parts

※Chose one of inductors in Table. 3

Selection of L1, C1 and D1 are very important because they affect DCDC converter performance directly. For stability operation, AKM recommends them described in Table. 3

1. Grounding and Power Supply Decoupling

The AK7844 requires careful attention to power supply and grounding arrangements. VBAT is usually supplied from Li-Ion battery in the system. VDD1 and VDD2 are supplied from smoothed boosted voltage. VSS1, VSS2, VSS3 and VSS4 must be connected to analog ground plane. Analog and digital ground in the system should be connected together near where the supplies are brought onto the printed circuit board. Decoupling capacitors with the small value ceramic (C7,C8) should be as close to the AK7844 as possible.

2. Voltage Reference

VC is a signal ground of this device. A 0.01 μ F ceramic capacitor (C3) between VC and VSS4 pin eliminates the effects of high frequency noise. This capacitor should be as close to the VC pin as possible. Do not take out load current from the VC pin. All signals, especially clocks should be kept away from the VC pin in order to avoid unwanted coupling.

3. Class-D analog Inputs

AC-coupling capacitors are necessary in series to INL and INR respectively.

4. Class-D Outputs

The Class-D outputs are in BTL signal format. Locate the outputs close to the speaker to minimize interconnect resistance and capacitance to suppress noise. Match the length and pattern of the plus and minus output interconnect. Keep AK7844 or Class-D outputs away as far away as possible from the devices such as antennas that are sensitive to high frequency noise.

5. Effect on RF bands

Power Booster or Class-D Outputs may affect high frequency signal outside the AK7844. Apply previous section (4. Class-D Outputs) in PCB layout.

6. Drivable Piezo Speakers

The AK7844 is designed to drive typical piezo speakers but in some cases electric characteristics of the speakers differ by manufacturers. Feel free to ask us whether your speakers can be driven or not before using them.

7. Boost DCDC Converter

Ceramic capacitor (C1, C9), Inductance (L1) and Schottky Diode (D1) should be located as close to the AK7844 as possible.

PACKAGE

■ MARKING



XXXX : Date code (4 digit)

■ 31pin WL-CSP Package Outline (Unit : mm)

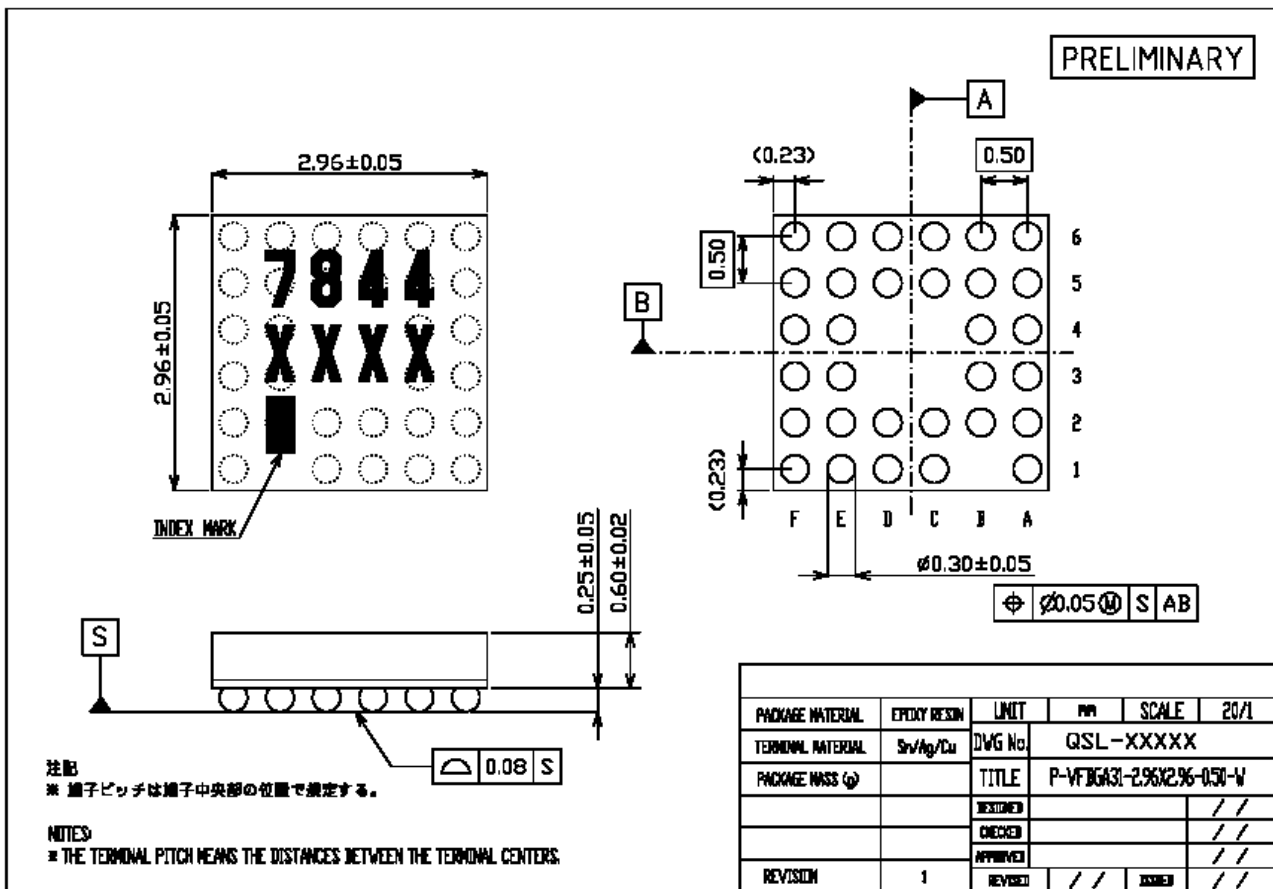

IMPORTANT NOTICE

These products and their specifications are subject to change without notice. Before considering any use or application, consult the Asahi Kasei Microsystems Co., Ltd. (AKM) sales office or authorized distributor concerning their current status.

AKM assumes no liability for infringement of any patent, intellectual property, or other right in the application or use of any information contained herein.

Any export of these products, or devices or systems containing them, may require an export license or other official approval under the law and regulations of the country of export pertaining to customs and tariffs, currency exchange, or strategic materials.

AKM products are neither intended nor authorized for use as critical components in any safety, life support, or other hazard related device or system, and AKM assumes no responsibility relating to any such use, except with the express written consent of the Representative Director of AKM. As used here:

A hazard related device or system is one designed or intended for life support or maintenance of safety or for applications in medicine, aerospace, nuclear energy, or other fields, in which its failure to function or perform may reasonably be expected to result in loss of life or in significant injury or damage to person or property.

A critical component is one whose failure to function or perform may reasonably be expected to result, whether directly or indirectly, in the loss of the safety or effectiveness of the device or system containing it, and which must therefore meet very high standards of performance and reliability.

It is the responsibility of the buyer or distributor of an AKM product who distributes, disposes of, or otherwise places the product with a third party to notify that party in advance of the above content and conditions, and the buyer or distributor agrees to assume any and all responsibility and liability for and hold AKM harmless from any and all claims arising from the use of said product in the absence of such notification.

Revision History

Date (YY/MM/DD)	Revision	Reason	Page	Contents
07/08/07	00	-		First edition in English
07/09/13	01	addition	11-15	TYPICAL CHARACTERISTICS