

Silicon NPN Power Transistors

2SC3152

DESCRIPTION

- With TO-3PN package
- High breakdown voltage ( $V_{CBO} = 900V$ )
- Fast switching speed
- Wide ASO ( Safe Operating Area )

APPLICATIONS

- 800V/3A Switching Regulator Applications

PINNING

PIN	DESCRIPTION
1	Base
2	Collector;connected to mounting base
3	Emitter

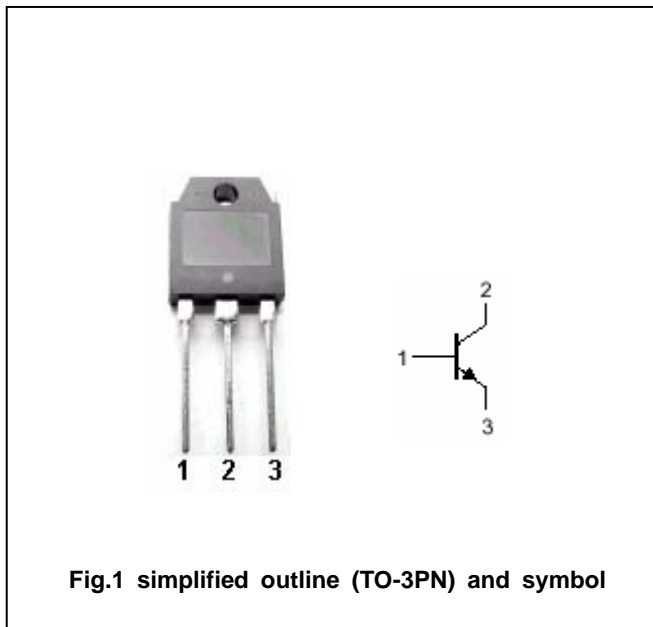

Fig.1 simplified outline (TO-3PN) and symbol

Absolute maximum ratings ( $T_a=25^\circ C$  )

SYMBOL	PARAMETER	CONDITIONS	VALUE	UNIT
$V_{CBO}$	Collector-base voltage	Open emitter	900	V
$V_{CEO}$	Collector-emitter voltage	Open base	800	V
$V_{EBO}$	Emitter-base voltage	Open collector	7	V
$I_C$	Collector current		3	A
$I_{CM}$	Collector current-peak		10	A
$I_B$	Base current		1.5	A
$P_C$	Collector power dissipation	$T_C=25$	80	W
$T_j$	Junction temperature		150	
$T_{stg}$	Storage temperature		-55~150	

## Silicon NPN Power Transistors

## 2SC3152

## CHARACTERISTICS

T<sub>j</sub>=25 unless otherwise specified

SYMBOL	PARAMETER	CONDITIONS	MIN	TYP.	MAX	UNIT
V <sub>(BR)CEO</sub>	Collector-emitter breakdown voltage	I <sub>C</sub> =5mA ; R <sub>BE</sub> =	800			V
V <sub>(BR)CBO</sub>	Collector-base breakdown voltage	I <sub>C</sub> =1mA ; I <sub>E</sub> =0	900			V
V <sub>(BR)EBO</sub>	Emitter-base breakdown voltage	I <sub>E</sub> =1mA ; I <sub>C</sub> =0	7			V
V <sub>CEsat</sub>	Collector-emitter saturation voltage	I <sub>C</sub> =1.5A ; I <sub>B</sub> =0.3A			2.0	V
V <sub>BEsat</sub>	Base-emitter saturation voltage	I <sub>C</sub> =1.5A ; I <sub>B</sub> =0.3A			1.5	V
I <sub>CBO</sub>	Collector cut-off current	V <sub>CB</sub> =800V ; I <sub>E</sub> =0			10	μA
I <sub>EBO</sub>	Emitter cut-off current	V <sub>EB</sub> =5V ; I <sub>C</sub> =0			10	μA
h <sub>FE-1</sub>	DC current gain	I <sub>C</sub> =0.2A ; V <sub>CE</sub> =5V	10		40	
h <sub>FE-2</sub>	DC current gain	I <sub>C</sub> =1A ; V <sub>CE</sub> =5V	8			
C <sub>OB</sub>	Output capacitance	I <sub>E</sub> =0 ; V <sub>CB</sub> =10V ; f=1MHz		60		pF
f <sub>T</sub>	Transition frequency	I <sub>C</sub> =0.2A ; V <sub>CE</sub> =10V		15		MHz

## Switching times

t <sub>on</sub>	Turn-on time	I <sub>C</sub> =2A ; I <sub>B1</sub> =0.4A ; I <sub>B2</sub> =-0.8A R <sub>L</sub> =20 Ω , V <sub>CC</sub> =400V			1.0	μs
t <sub>s</sub>	Storage time				3.0	μs
t <sub>f</sub>	Fall time				0.7	μs

◆ h<sub>FE-1</sub> classifications

K	L	M
10-20	15-30	20-40

Silicon NPN Power Transistors

2SC3152

PACKAGE OUTLINE

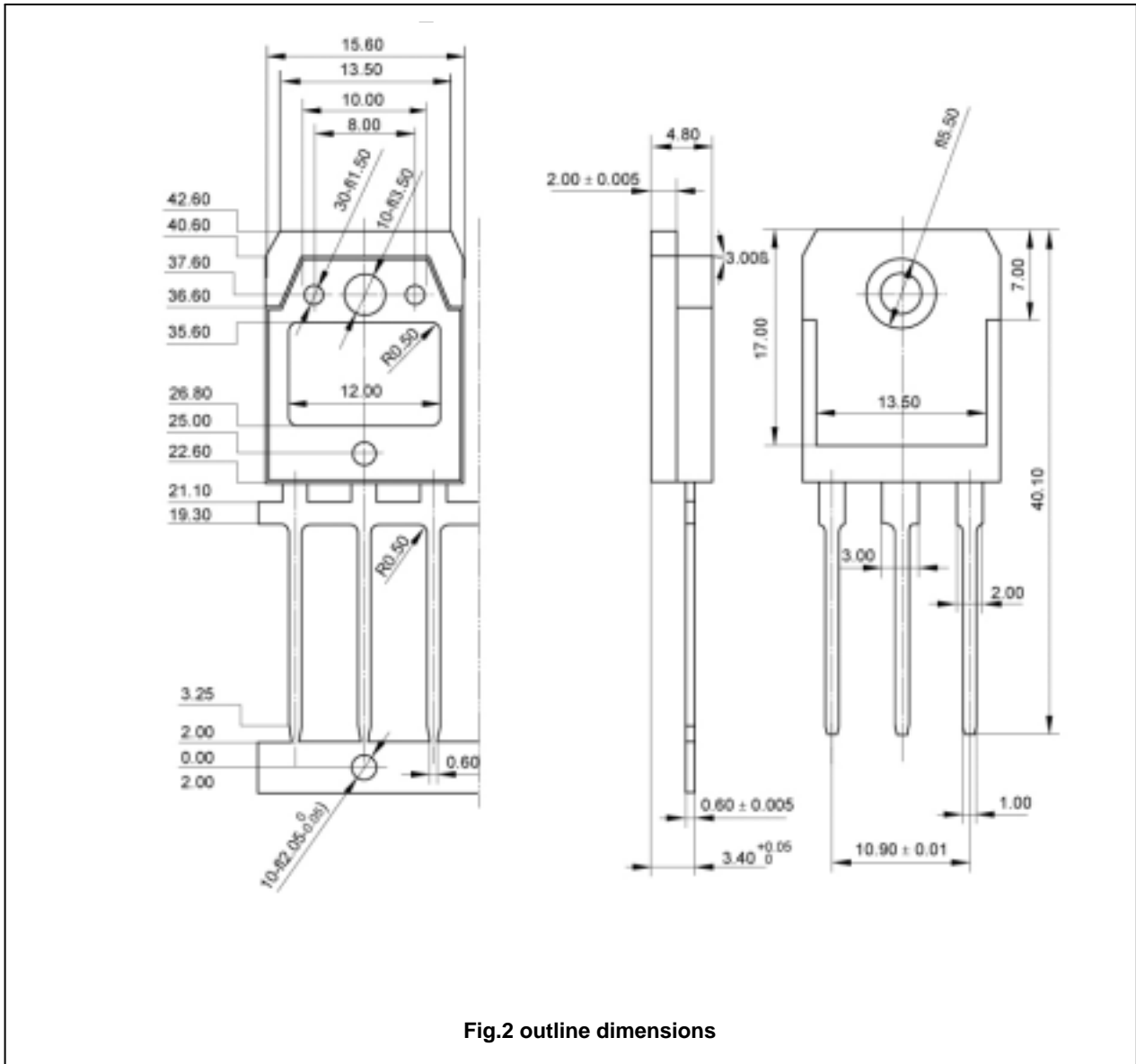

Fig.2 outline dimensions

Silicon NPN Power Transistors

2SC3152

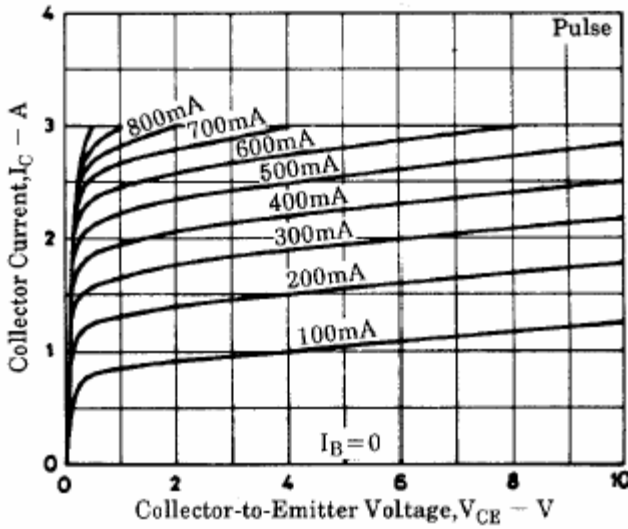

Fig.3 Static Characteristic

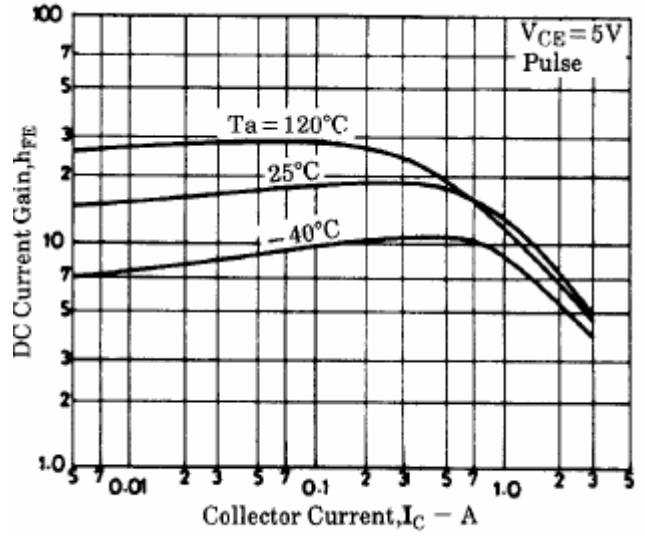

Fig.4 DC current Gain

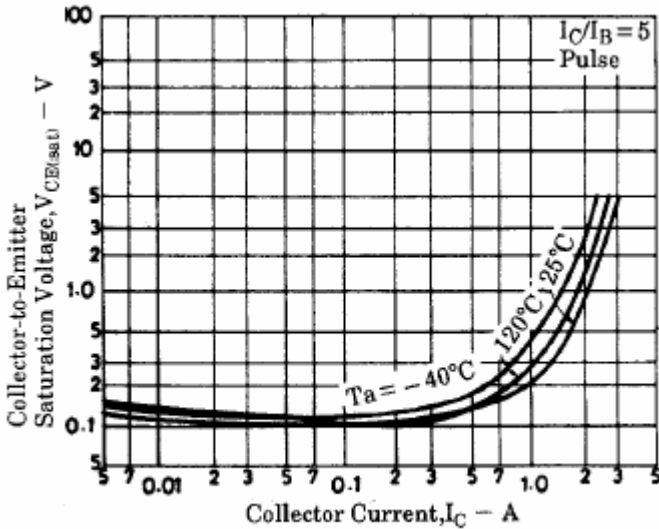

Fig.5 Collector-Emmitter Saturation Voltage

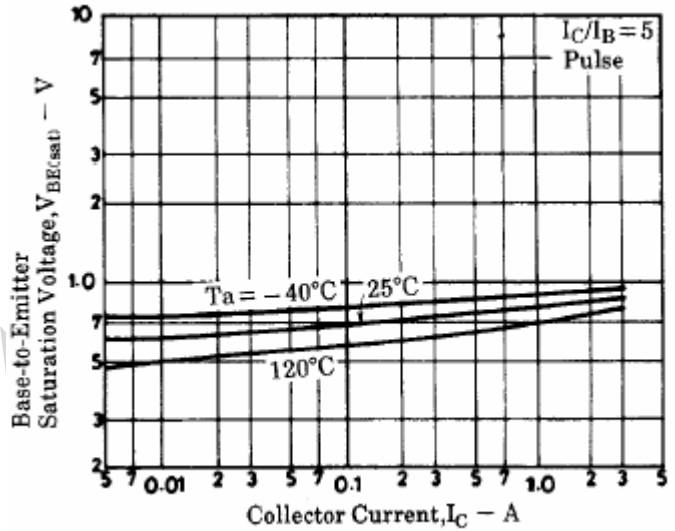

Fig.6 Base-Emmitter Saturation Voltage

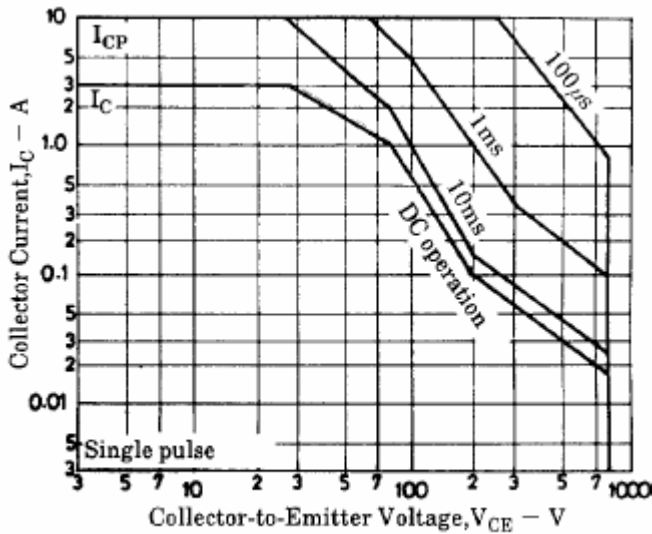

Fig.7 Safe Operating Area