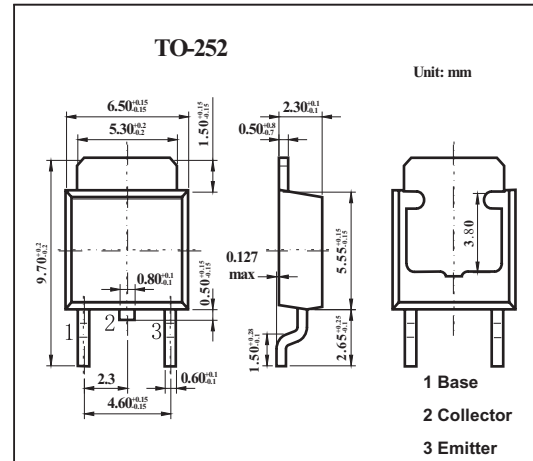

Silicon PNP Epitaxial Planar Type

2SB934

■ Features

- Low collector-emitter saturation voltage $V_{CE(sat)}$.
- Satisfactory linearity of forward current transfer ratio h_{FE} .
- Large collector current I_c .

■ Absolute Maximum Ratings $T_a = 25^\circ\text{C}$

Parameter	Symbol	Rating	Unit
Collector-base voltage	V_{CBO}	-130	V
Collector-emitter voltage	V_{CEO}	-80	V
Emitter-base voltage	V_{EBO}	-7	V
Collector current	I_c	-7	A
Peak collector current	I_{CP}	-15	A
Collector power dissipation	P_C	1.3	W
Junction temperature	T_j	150	$^\circ\text{C}$
Storage temperature	T_{stg}	-55 to +150	$^\circ\text{C}$

■ Electrical Characteristics $T_a = 25^\circ\text{C}$

Parameter	Symbol	Testconditions	Min	Typ	Max	Unit
Collector-emitter voltage	V_{CEO}	$I_c = -10\text{mA}, I_B = 0$	-80			V
Collector-base cutoff current	I_{CBO}	$V_{CB} = -100\text{V}, I_E = 0$			-10	μA
Emitter-base cutoff current	I_{EBO}	$V_{EB} = -5\text{V}, I_C = 0$			-50	μA
Forward current transfer ratio	h_{FE}	$V_{CE} = -2\text{V}, I_c = -3\text{A}$	90		260	V
		$V_{CE} = -2\text{V}, I_c = -0.1\text{A}$	45			
Base-emitter saturation voltage	$V_{BE(sat)}$	$I_c = -5\text{A}, I_B = -0.25\text{A}$			-1.5	V
Collector-emitter saturation voltage	$V_{CE(sat)}$	$I_c = -5\text{A}, I_B = -0.25\text{A}$			-0.5	V
Transition frequency	f_T	$V_{CE} = -10\text{V}, I_c = -0.5\text{A}, f = 10\text{MHz}$		30		MHz
Turn-on time	t_{on}	$I_c = -3\text{A}, I_{B1} = -0.3\text{A}, I_{B2} = 0.3\text{A}, V_{CC} = -50\text{V}$		0.5		μs
Storage time	t_{stg}			1.5		μs
Fall time	t_f			0.1		μs

■ h_{FE} Classification

Rank	Q	P
h_{FE}	90~180	130~260