

PRELIMINARY SPEC

Features

- SUBMINIATURE PACKAGE.
- WIDE VIEWING ANGLE.
- YOKE LEAD.
- LONG LIFE-SOLID STATE RELIABILITY.
- LOW PACKAGE PROFILE.
- PACKAGE : 1000PCS / REEL.
- MOISTURE SENSITIVITY LEVEL : LEVEL 3.
- RoHS COMPLIANT.



Notes:

1. All dimensions are in millimeters (inches).
2. Tolerance is $\pm 0.25(0.01")$ unless otherwise noted.
- 3.Specifications are subject to change without notice.

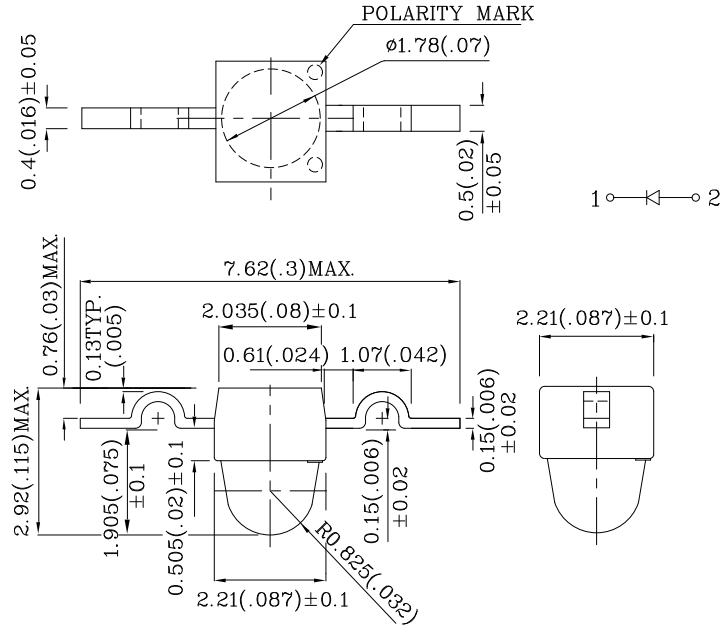

Absolute Maximum Ratings ($T_A=25^\circ\text{C}$)		M2CY (AllInGaP)	Unit
Reverse Voltage	V_R	5	V
Forward Current	I_F	30	mA
Forward Current (Peak) 1/10 Duty Cycle 0.1ms Pulse Width	i_{FS}	140	mA
Power Dissipation	P_T	84	mW
Operating Temperature	T_A	-40 ~ +85	°C
Storage Temperature	T_{stg}	-40 ~ +85	

Operating Characteristics ($T_A=25^\circ\text{C}$)		M2CY (AllInGaP)	Unit
Forward Voltage (Typ.) ($I_F=20\text{mA}$)	V_F	2.3	V
Forward Voltage (Max.) ($I_F=20\text{mA}$)	V_F	2.8	V
Reverse Current (Max.) ($V_R=5\text{V}$)	I_R	10	μA
Wavelength Of Peak Emission (Typ.) ($I_F=20\text{mA}$)	λ_P	590	nm
Wavelength Of Dominant Emission (Typ.) ($I_F=20\text{mA}$)	λ_D	589	nm
Spectral Line Full Width At Half-Maximum (Typ.) ($I_F=20\text{mA}$)	$\Delta\lambda$	20	nm
Capacitance (Typ.) ($V_F=0\text{V}$, $f=1\text{MHz}$)	C	45	pF

Part Number	Emitting Color	Emitting Material	Lens-color	Luminous Intensity ($I_F=20\text{mA}$) mcd		Wavelength nm λ_P	Viewing Angle $2\theta_{1/2}$
				min.	typ.		
ZM2CY64W-8	Yellow	AllInGaP	Water Clear	1200	2990	590	20°

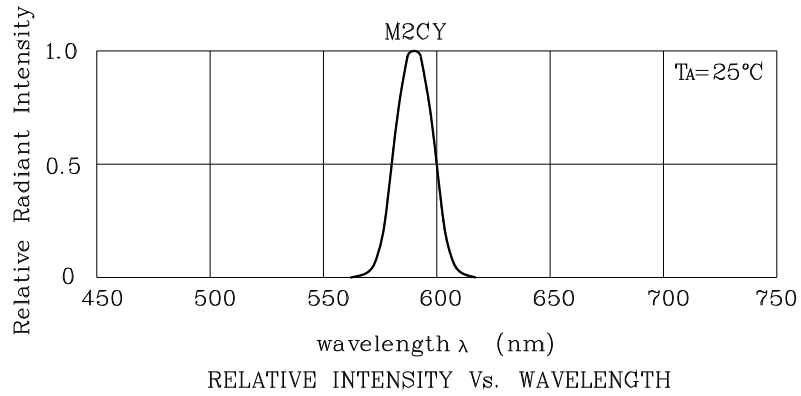

❖ M2CY

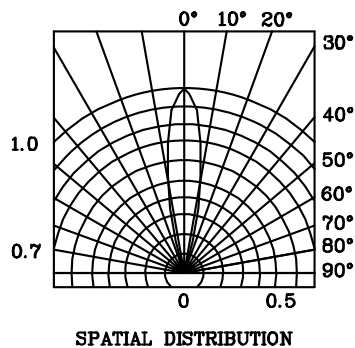
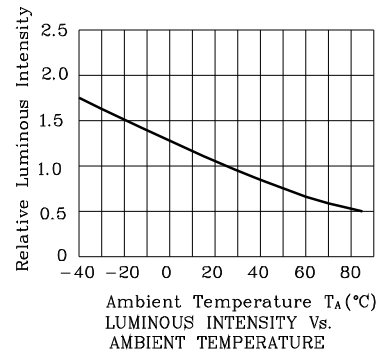
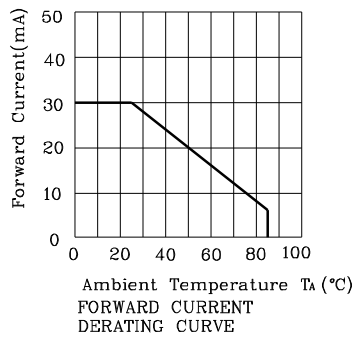
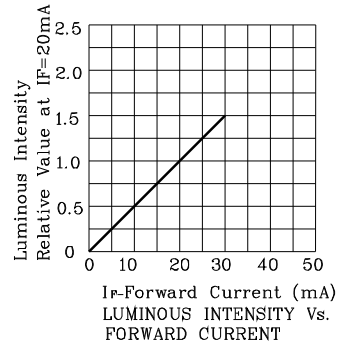
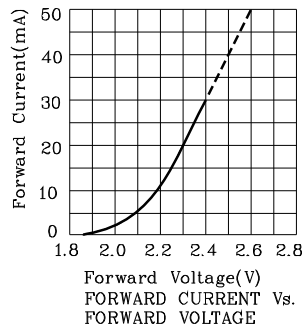

Reflow Soldering Profile For Lead-free SMT Process.

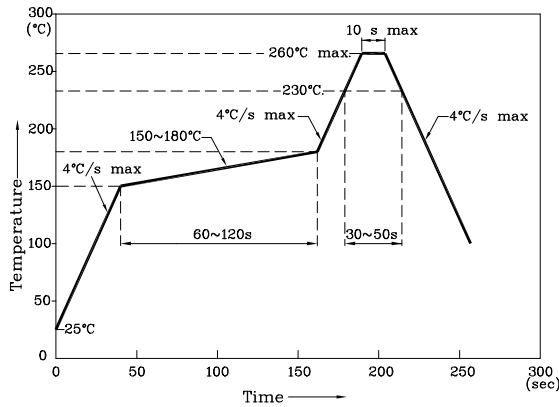

NOTES:

1. Maximum soldering temperature should not exceed 260°C.
2. Recommended reflow temperature: 145°C-260°C.
3. Do not put stress to the epoxy resin during high temperatures conditions.

❖ Recommended Soldering Pattern
(Units : mm; Tolerance:± 0.1)

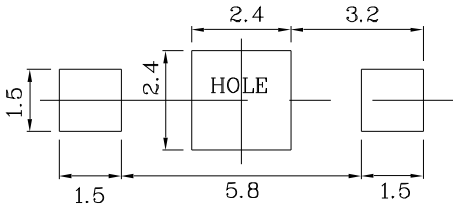

❖ The device has a single mounting surface. The device must be mounted according to the specifications.

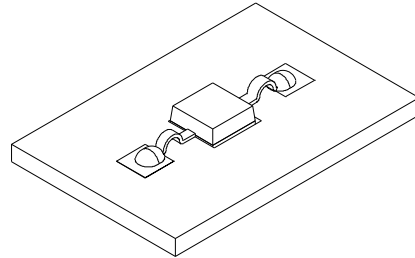

❖ Tape Specification (Units : mm)

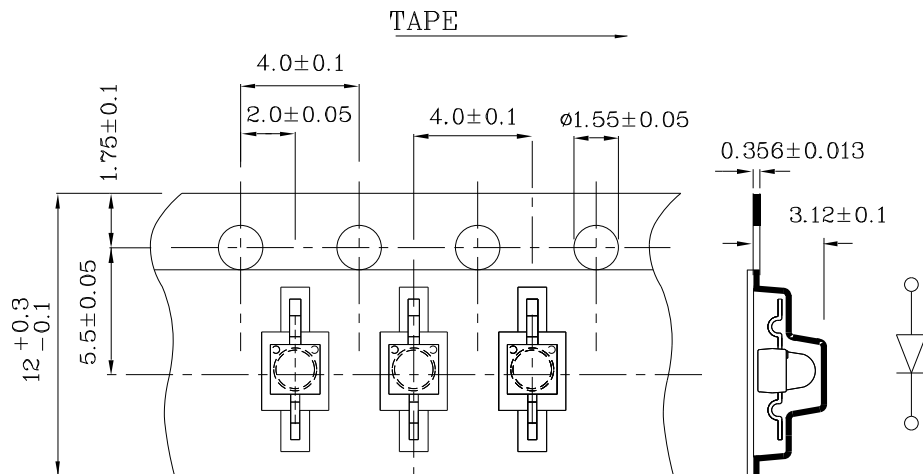

Remarks:



If special sorting is required (e.g. binning based on forward voltage, Luminous intensity / luminous flux, or wavelength), the typical accuracy of the sorting process is as follows:

1. Wavelength: +/-1nm
2. Luminous intensity / luminous flux: +/-15%
3. Forward Voltage: +/-0.1V

Note: Accuracy may depend on the sorting parameters.

PACKING & LABEL SPECIFICATIONS

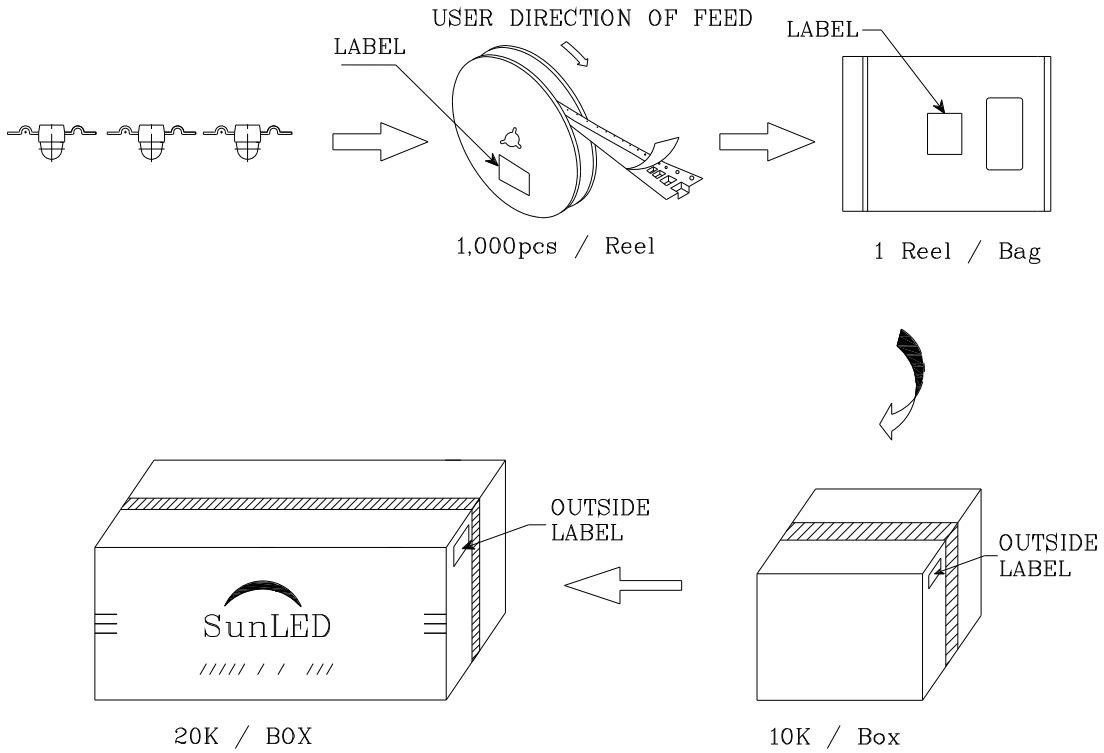
ZM2CY64W-8

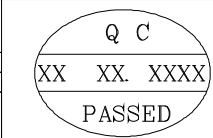
P/NO : Zxx64x-8	
QTY : 1,000 pcs	CODE: XXX
S/N : XX	
LOT NO:	
 XXXXXXXXXXXXXXXXXXXXXXXX	
RoHS Compliant	