

FEATURES

- Industry Standard 12.7x12.7mm SMT Footprint
- +5Vdc Supply Voltage
- -40°C to +85°C Temp. Range
- Low Phase Noise
- Tape & Reel Packaging
- Fully compliant to RoHS Directive 2002/95/EC

DESCRIPTION

The CTS VCO3035A is a single band high performance SMT VCO. Its low phase noise makes it the ideal choice for any wireless telecommunications system.

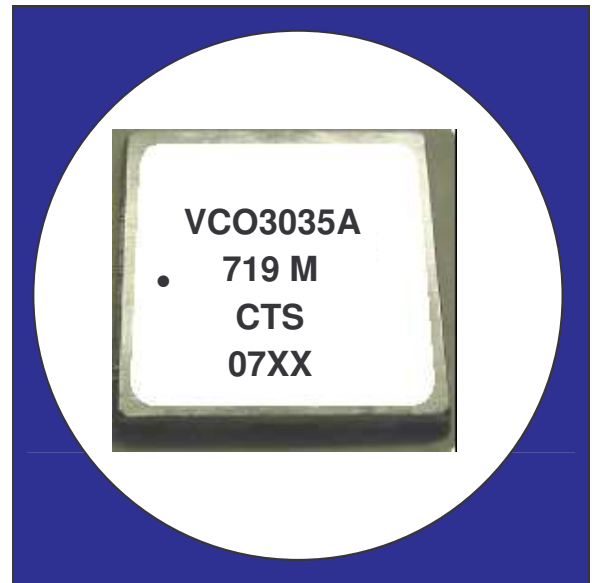

- See WWW.CTSCORP.COM for product patent status.

ELECTRICAL SPECIFICATIONS

Parameter	Conditions & Remarks	Min	Typical	Max	Unit
Operating Frequency	F _{OUT}	719	-	754	MHz
Supply Voltage	V _{CC}	4.75	5.0	5.25	Vdc
Supply Current	I _{CC}	-	-	21	mA
Operating Temperature Range	T _{OP}	-40	-	+85	°C
Tuning Voltage Range	V _T	0.5	-	4.5	Vdc
Tuning Sensitivity		-	15	18	MHz/V
Power Output	(RF Amplitude)	-3	0	-	dBm
Pushing	(5V +/- .3V)	-5	-	5	MHz/V
Pulling	(VSWR = 1.67:1)	-5	-	5	MHz
Harmonics		-	-	-8	dBc
Spurious Response		-	-	-85	dBc
Phase Noise	1KHz	-	-	-73	dBc/Hz
	10kHz	-	-100	-98	dBc/Hz
	100kHz	-	-	-122	dBc/Hz
	1MHz	-	-144	-142	dBc/Hz

MECHANICAL SPECIFICATIONS:

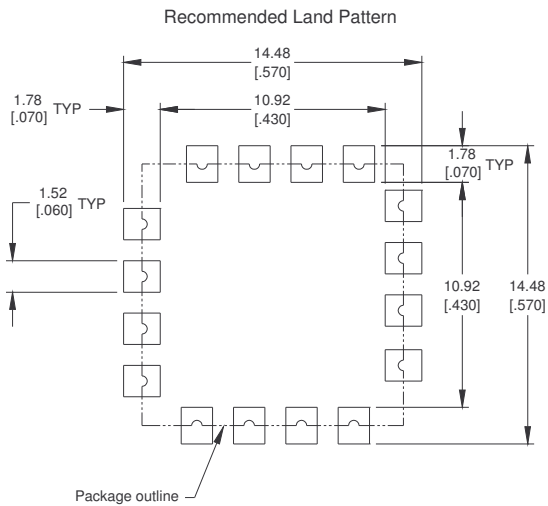
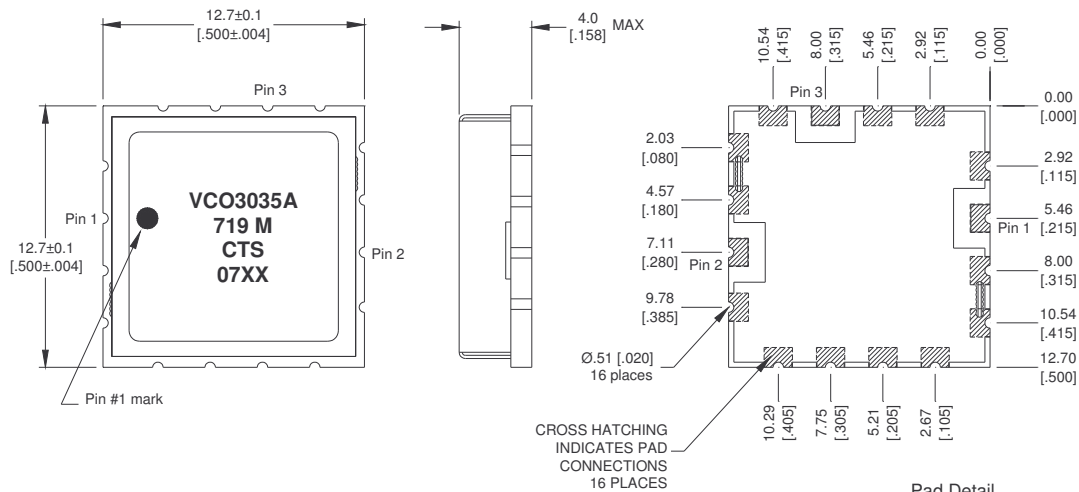

Function table

Pin	Function
1	Vt
2	RF Output
3	Vcc
4-16	GND

Note: The Lid/Sheild is grounded.

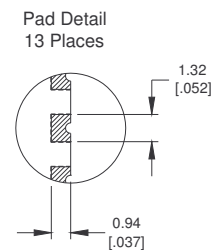
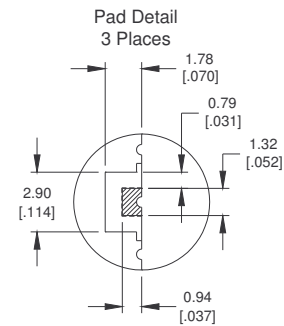
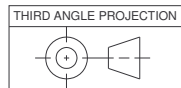

All dimensions are in MM [Inches].
 All dimensions are nominal unless otherwise specified.
 Lead Termination Finish: Gold Flash, <10 micro inch, over Ni plated Cu.

Tape & Reel Information:

Tape width 24 mm, pitch 16 mm, as per EIA 481-2, 1000 units max per 330 mm reel.

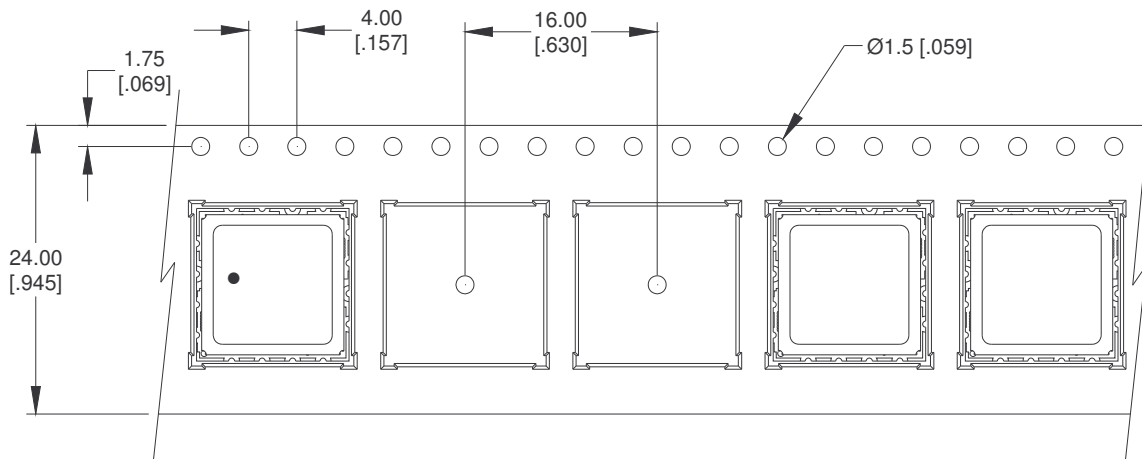

All dimensions are in MM [INCHES].

All dimensions are Nominal

STANDARD ENVIRONMENTAL LIMITS:

This product is capable of operating within the following environmental conditions:

Operating Temperature: -40 to +85 °C.

Humidity: 85% Relative humidity max @ 50°C.

Solder Reflow Conditions: Device is capable of withstanding reflow of 260 degrees C for 10 seconds maximum.

Atmospheric Pressure: 730 to 780 mm Hg.

Moisture Sensitivity: MSL 1

RoHS: This device is fully compliant to RoHS Directive 2002/95/EC