

Rail-to-rail 1.8V high-speed comparator

Features

- Propagation delay: 33ns
- Low current consumption: 64µA
- Rail-to-rail inputs
- Push-pull outputs
- Supply operation from 1.8V to 5V
- Wide temperature range: -40°C to +125°C
- ESD tolerance: 2kV HBM / 200V MM
- Latch-up immunity: 200mA
- SMD packages

Applications

- Telecom
- Instrumentation
- Signal conditioning
- High-speed sampling systems
- Portable communication systems

Description

The TS3021 and TS3022 single and dual comparators feature high-speed response time with rail-to-rail inputs. Specified from 2V to 5V supply voltage, these comparators can operate over a wide temperature range: -40°C to +125°C.

The TS3021 and TS3022 comparators offer micropower consumption as low as a few tens of microamperes thus providing an excellent ratio of power consumption current versus response time.

The TS3021 and TS3022 include push-pull outputs and are available in small packages (SMD).

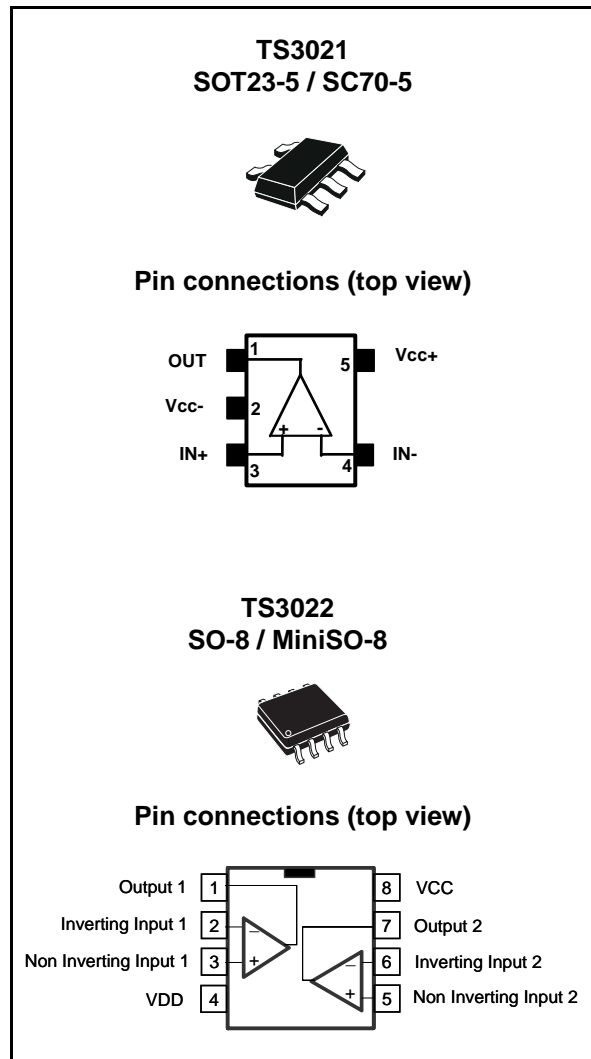

1 Absolute maximum ratings and operating conditions

Table 1. Absolute maximum ratings

Symbol	Parameter	Value	Unit
V _{CC}	Supply voltage ⁽¹⁾	5.5	V
V _{ID}	Differential input voltage ⁽²⁾	±5	V
V _{IN}	Input voltage range	V _{DD} -0.3 to V _{CC} +0.3	V
R _{thja}	Thermal resistance junction to ambient ⁽³⁾		°C/W
	SC70-5	205	
	SOT23-5	250	
	SO-8 MiniSO-8	125 190	
R _{thjc}	Thermal resistance junction to case ⁽³⁾		°C/W
	SC70-5	172	
	SOT23-5	81	
	SO-8 MiniSO-8	40 39	
P _D	Power dissipation ⁽⁴⁾		mW
	SC70-5	600	
	SOT23-5	500	
	SO-8 MiniSO-8	1000 650	
T _{stg}	Storage temperature	-65 to +150	°C
T _j	Junction temperature	150	°C
T _{LEAD}	Lead temperature (soldering 10 seconds)	260	°C
ESD	Human body model (HBM) ⁽⁵⁾	2000	V
	Machine model (MM) ⁽⁶⁾	200	
	Latch-up immunity	200	mA

1. All voltage values, except differential voltage, are referenced to V_{DD}.
2. The magnitude of input and output voltages must never exceed the supply rail ±0.3V.
3. Short-circuits can cause excessive heating. These values are typical.
4. P_D is calculated with T_{amb}=+25°C, T_j=+150°C and corresponding R_{thja}.
5. Human body model: A 100pF capacitor is charged to the specified voltage, then discharged through a 1.5kΩ resistor between two pins of the device. This is done for all couples of connected pin combinations while the other pins are floating.
6. Machine model: A 200pF capacitor is charged to the specified voltage, then discharged directly between two pins of the device with no external series resistor (internal resistor < 5Ω). This is done for all couples of connected pin combinations while the other pins are floating.

Table 2. Operating conditions

Symbol	Parameter	Value	Unit
T_{oper}	Operating temperature range	-40 to +125	°C
V_{CC}	Supply voltage $0^{\circ}\text{C} < T_{amb} < +125^{\circ}\text{C}$ $-40^{\circ}\text{C} < T_{amb} < +125^{\circ}\text{C}$	1.8 to 5 2 to 5	V
V_{icm}	Common mode input voltage range $-40^{\circ}\text{C} < T_{amb} < +85^{\circ}\text{C}$ $+85^{\circ}\text{C} < T_{amb} < +125^{\circ}\text{C}$	$V_{DD}-0.2$ to $V_{CC}+0.2$ V_{DD} to V_{CC}	V

2 Electrical characteristics

Table 3. $V_{CC}=+2V$, $T_{amb} = +25^{\circ}C$, full V_{icm} range (unless otherwise specified)⁽¹⁾

Symbol	Parameter	Test conditions	Min.	Typ.	Max.	Unit
V_{IO}	Input offset voltage	$-40^{\circ}C < T_{amb} < +125^{\circ}C$	-	0.5	8 10	mV
ΔV_{IO}	Input offset voltage drift	$-40^{\circ}C < T_{amb} < +125^{\circ}C$	-	3	20	$\mu V/^{\circ}C$
I_{IO}	Input offset current ⁽²⁾	$-40^{\circ}C < T_{amb} < +125^{\circ}C$	-	1	20 100	nA
I_{IB}	Input bias current ⁽²⁾	$-40^{\circ}C < T_{amb} < +125^{\circ}C$	-	80	160 300	nA
I_{CC}	Supply current	No load, output low, $V_{icm}=0V$ $-40^{\circ}C < T_{amb} < +125^{\circ}C$ No load, output high, $V_{icm}=0V$ $-40^{\circ}C < T_{amb} < +125^{\circ}C$	-	75 64	105 115 90 125	μA
I_{SC}	Short-circuit current	Source Sink	-	12 13	-	mA
V_{OH}	Output voltage high	$I_{source}=1mA$ $-40^{\circ}C < T_{amb} < +125^{\circ}C$	1.88 1.80	1.94	-	V
V_{OL}	Output voltage low	$I_{source}=1mA$ $-40^{\circ}C < T_{amb} < +125^{\circ}C$	-	50	100 150	mV
CMRR	Common mode rejection ratio	$0 < V_{icm} < 2V$	-	67	-	dB
SVR	Supply voltage rejection	$\Delta V_{CC}= 2$ to $5V$	58	69	-	dB
TP_{LH}	Propagation delay Low to high output level	$V_{icm}= 0V$, $f=10kHz$, $C_L=50pF$, Overdrive = 20mV Overdrive = 100mV	-	39 33	75 60	ns
TP_{HL}	Propagation delay High to low output level	$V_{icm}= 0V$, $f=10kHz$, $C_L=50pF$, Overdrive = 20mV Overdrive = 100mV	-	39 33	75 60	ns
T_F	Fall time	$f=10kHz$, $C_L=50pF$, $R_L=10k\Omega$, Overdrive = 100mV	-	8	-	ns
T_R	Rise time	$f=10kHz$, $C_L=50pF$, $R_L=10k\Omega$, Overdrive = 100mV	-	9	-	ns

1. All values over the temperature range are guaranteed through correlation and simulation. No production test is performed at the temperature range limits.

2. Maximum values include unavoidable inaccuracies of the industrial tests.

Table 4. $V_{CC}=+3.3V$, $T_{amb} = +25^{\circ}C$, full V_{icm} range (unless otherwise specified)⁽¹⁾

Symbol	Parameter	Test conditions	Min.	Typ.	Max.	Unit
V_{IO}	Input offset voltage	$-40^{\circ}C < T_{amb} < +125^{\circ}C$	-	0.5	8 10	mV
ΔV_{IO}	Input offset voltage drift	$-40^{\circ}C < T_{amb} < +125^{\circ}C$	-	3	20	$\mu V/^{\circ}C$
I_{IO}	Input offset current ⁽²⁾	$-40^{\circ}C < T_{amb} < +125^{\circ}C$	-	1	20 100	nA
I_{IB}	Input bias current ⁽²⁾	$-40^{\circ}C < T_{amb} < +125^{\circ}C$	-	80	160 300	nA
I_{CC}	Supply current	No load, output low, $V_{icm}=0V$ $-40^{\circ}C < T_{amb} < +125^{\circ}C$ No load, output high, $V_{icm}=0V$ $-40^{\circ}C < T_{amb} < +125^{\circ}C$	-	77 65	110 120 90 125	μA
I_{SC}	Short circuit current	Source Sink	-	33 28	-	mA
V_{OH}	Output voltage high	$I_{source}=1mA$ $-40^{\circ}C < T_{amb} < +125^{\circ}C$	3.20 3.10	3.26	-	V
V_{OL}	Output voltage low	$I_{source}=1mA$ $-40^{\circ}C < T_{amb} < +125^{\circ}C$	-	30	80 150	mV
CMRR	Common mode rejection ratio	$0 < V_{icm} < 3.3V$	-	71	-	dB
SVR	Supply voltage rejection	$\Delta V_{CC}= 2$ to $5V$	58	69	-	dB
TP_{LH}	Propagation delay Low to high output level	$V_{icm}= 0V$, $f=10kHz$, $C_L=50pF$, Overdrive = 20mV Overdrive = 100mV	-	42 34	85 65	ns
TP_{HL}	Propagation delay High to low output level	$V_{icm}= 0V$, $f=10kHz$, $C_L=50pF$, Overdrive = 20mV Overdrive = 100mV	-	41 34	80 65	ns
T_F	Fall time	$f=10kHz$, $C_L=50pF$, $R_L=10k\Omega$, Overdrive = 100mV	-	5	-	ns
T_R	Rise time	$f=10kHz$, $C_L=50pF$, $R_L=10k\Omega$, Overdrive = 100mV	-	7	-	ns

1. All values over the temperature range are guaranteed through correlation and simulation. No production test is performed at the temperature range limits.
2. Maximum values include unavoidable inaccuracies of the industrial tests.

Table 5. $V_{CC}=+5V$, $T_{amb} = +25^{\circ}C$, full V_{icm} range (unless otherwise specified)⁽¹⁾

Symbol	Parameter	Test conditions	Min.	Typ.	Max.	Unit
V_{IO}	Input offset voltage	$-40^{\circ}C < T_{amb} < +125^{\circ}C$	-	0.5	8 10	mV
ΔV_{IO}	Input offset voltage drift	$-40^{\circ}C < T_{amb} < +125^{\circ}C$	-	3	20	$\mu V/^{\circ}C$
I_{IO}	Input offset current ⁽²⁾	$-40^{\circ}C < T_{amb} < +125^{\circ}C$	-	1	20 100	nA
I_{IB}	Input bias current ⁽²⁾	$-40^{\circ}C < T_{amb} < +125^{\circ}C$	-	80	160 300	nA
I_{CC}	Supply current	No load, output low, $V_{icm}=0V$ $-40^{\circ}C < T_{amb} < +125^{\circ}C$ No load, output high, $V_{icm}=0V$ $-40^{\circ}C < T_{amb} < +125^{\circ}C$	-	80 67	115 125 95 135	μA
I_{SC}	Short circuit current	Source Sink		62 47	-	mA
V_{OH}	Output voltage high	$I_{source}=4mA$ $-40^{\circ}C < T_{amb} < +125^{\circ}C$	4.80 4.70	4.87	-	V
V_{OL}	Output voltage low	$I_{source}=4mA$ $-40^{\circ}C < T_{amb} < +125^{\circ}C$	-	110	180 250	mV
CMRR	Common mode rejection ratio	$0 < V_{icm} < 5V$	-	72	-	dB
SVR	Supply voltage rejection	$\Delta V_{CC}= 2$ to $5V$	58	69	-	dB
TP_{LH}	Propagation delay Low to high output level	$V_{icm}= 0V$, $f=10kHz$, $C_L=50pF$, Overdrive = 20mV Overdrive = 100mV	-	48 38	105 75	ns
TP_{HL}	Propagation delay High to low output level	$V_{icm}= 0V$, $f=10kHz$, $C_L=50pF$, Overdrive = 20mV Overdrive = 100mV	-	46 38	95 75	ns
T_F	Fall time	$f=10kHz$, $C_L=50pF$, $R_L=10k\Omega$, Overdrive = 100mV	-	4	-	ns
T_R	Rise time	$f=10kHz$, $C_L=50pF$, $R_L=10k\Omega$, Overdrive = 100mV	-	4	-	ns

1. All values over the temperature range are guaranteed through correlation and simulation. No production test is performed at the temperature range limits.
2. Maximum values include unavoidable inaccuracies of the industrial tests.

Figure 1. Current consumption vs. power supply voltage

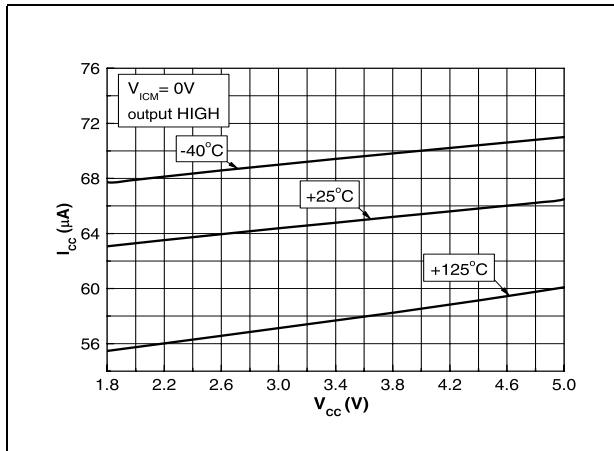

Figure 2. Current consumption vs. power supply voltage

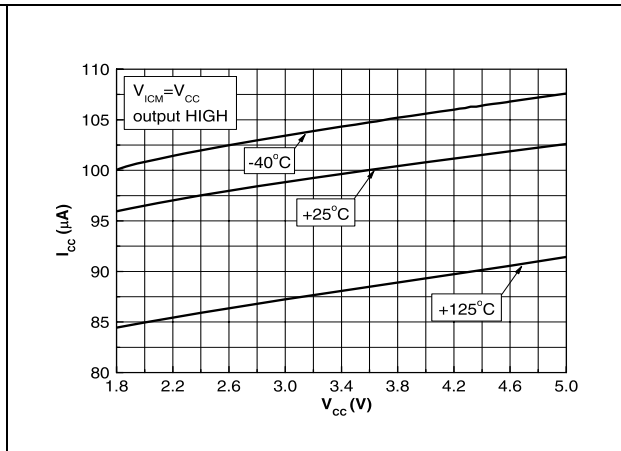

Figure 3. Current consumption vs. power supply voltage

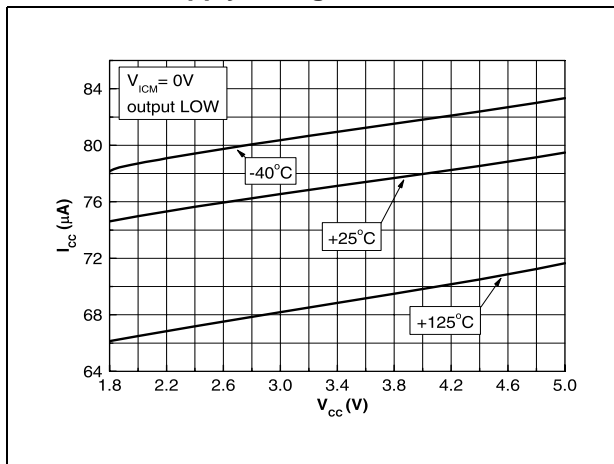

Figure 4. Current consumption vs. power supply voltage

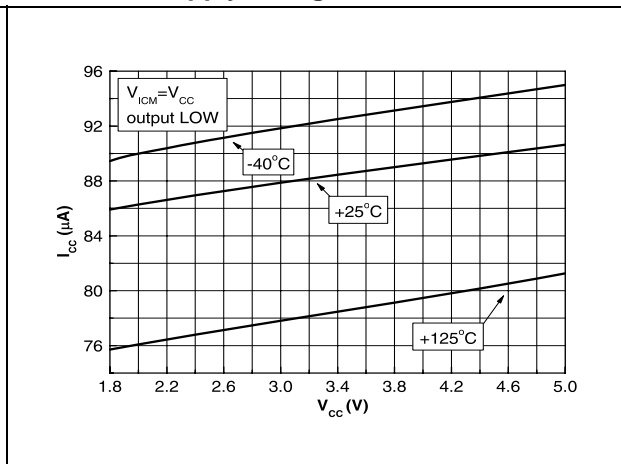

Figure 5. Output voltage vs. source current $V_{CC}=2V$

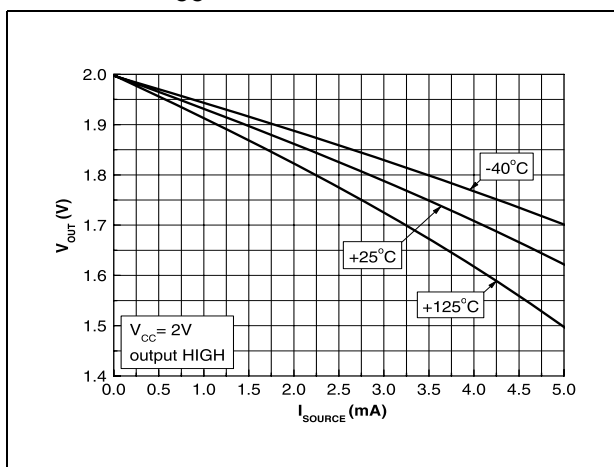

Figure 6. Output voltage vs. sink current $V_{CC}=2V$

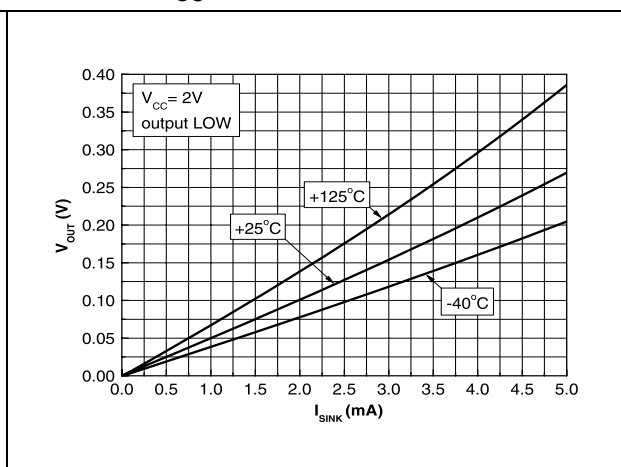

Figure 7. Output voltage vs. source current
 $V_{CC}=3.3V$

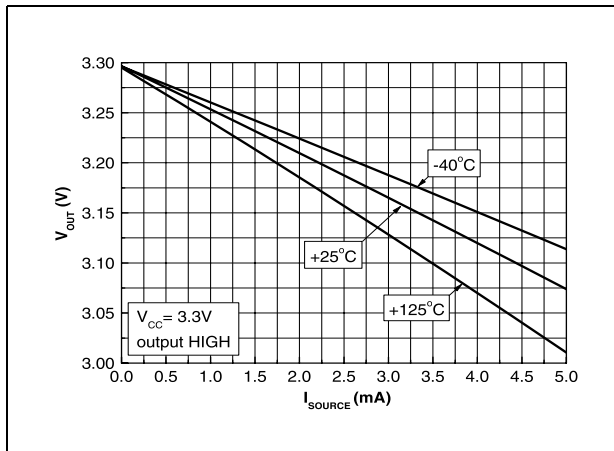

Figure 8. Output voltage vs. sink current
 $V_{CC}=3.3V$

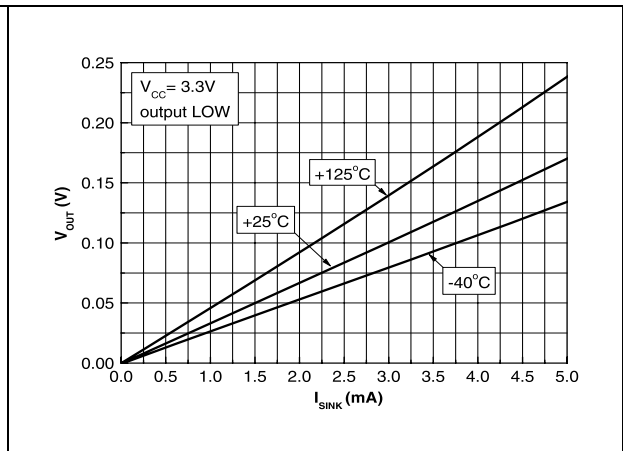

Figure 9. Output Voltage vs. source current
 $V_{CC}=5V$

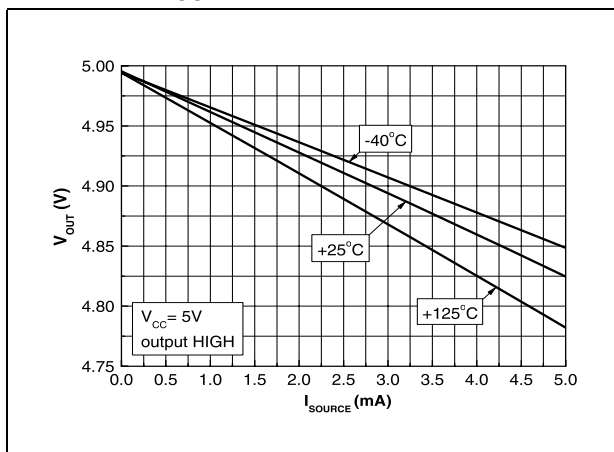

Figure 10. Output voltage vs. sink current
 $V_{CC}=5V$

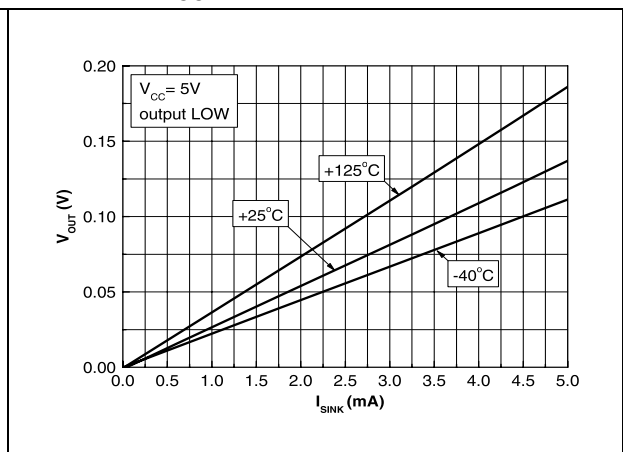

Figure 11. Input offset voltage vs. temperature and common mode voltage

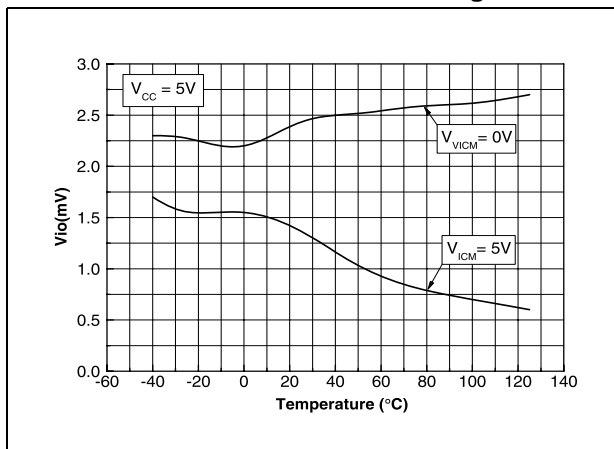

Figure 12. Input bias current vs. temperature and input voltage

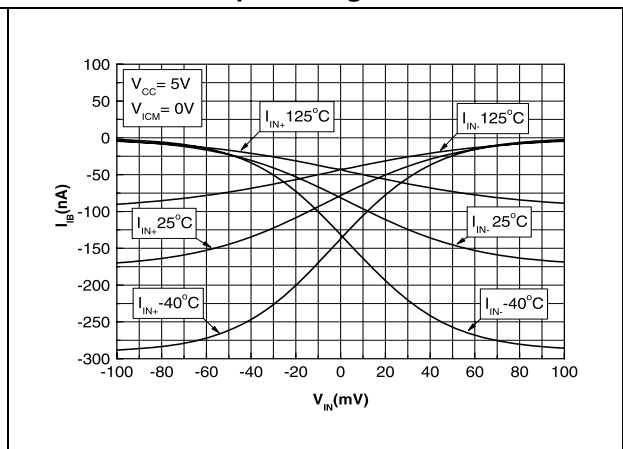

Figure 13. Current consumption vs. commutation frequency

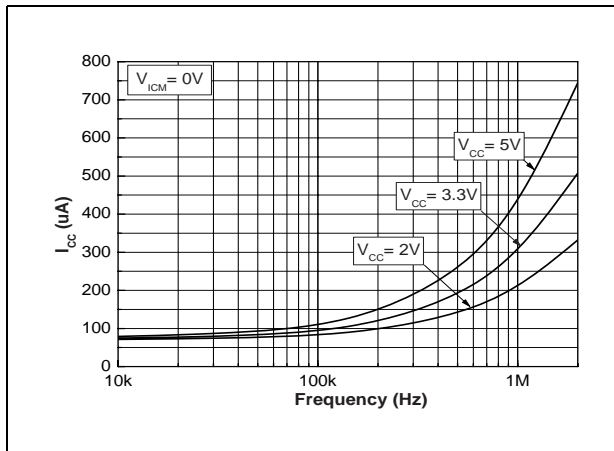

Figure 14. Propagation delay vs. overdrive $V_{CC}=2V$

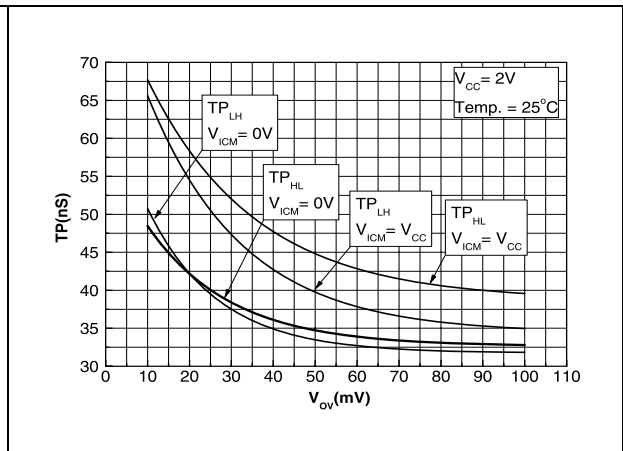

Figure 15. Propagation delay vs. overdrive $V_{CC}=2V$

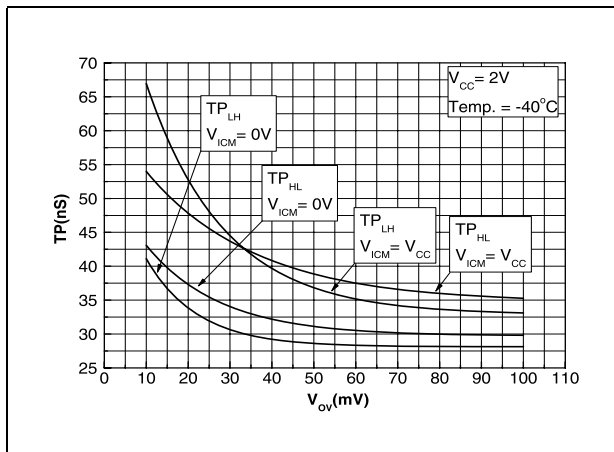

Figure 16. Propagation delay vs. overdrive $V_{CC}=2V$

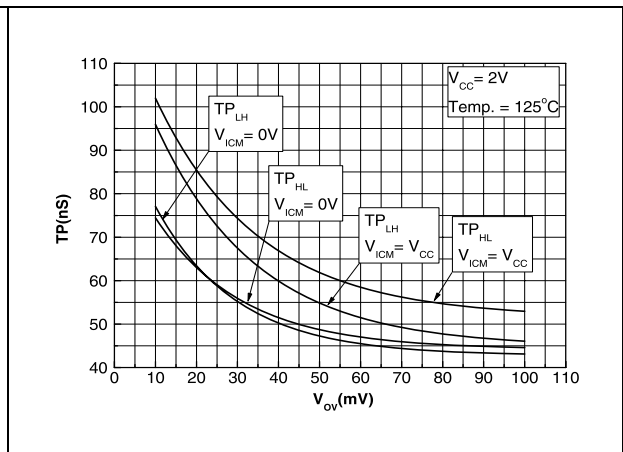

Figure 17. Propagation delay vs. overdrive $V_{CC}=3.3V$

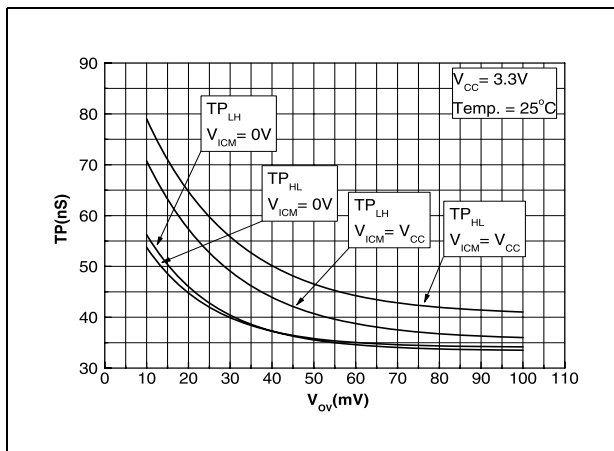

Figure 18. Propagation delay vs. overdrive $V_{CC}=3.3V$

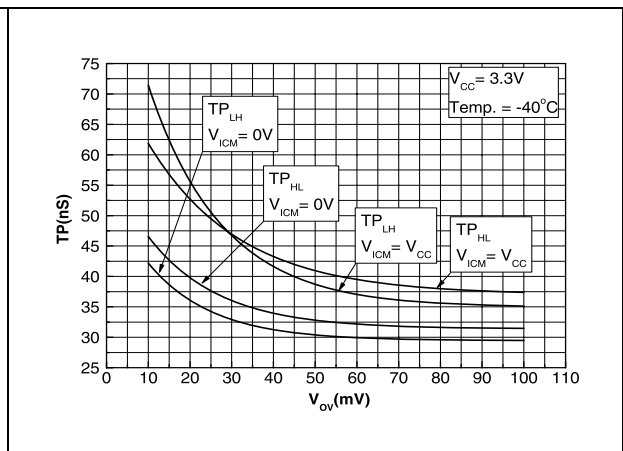

Figure 19. Propagation delay vs. overdrive
 $V_{CC}=3.3V$

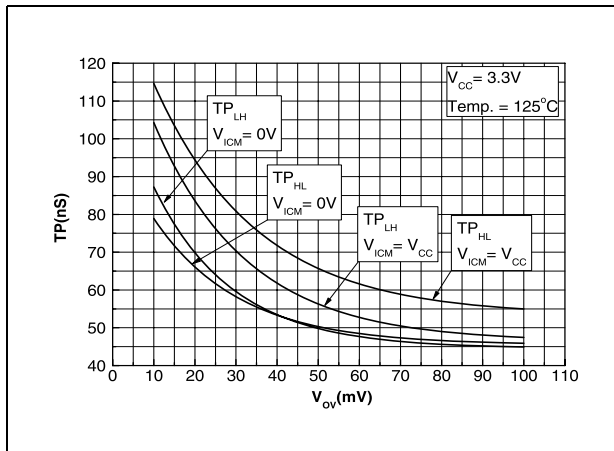

Figure 20. Propagation delay vs. overdrive
 $V_{CC}=5V$

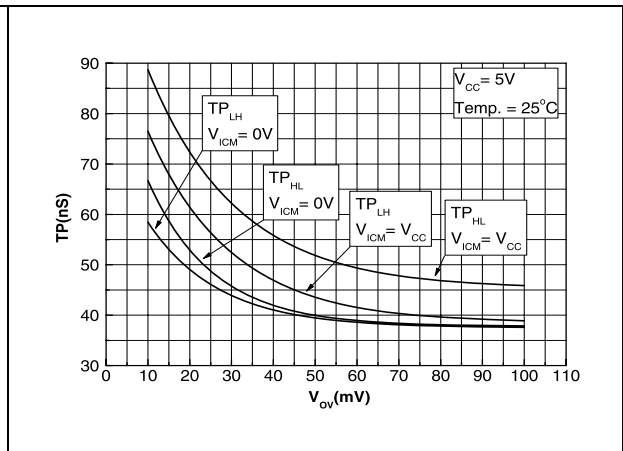

Figure 21. Propagation delay vs. overdrive
 $V_{CC}=5V$

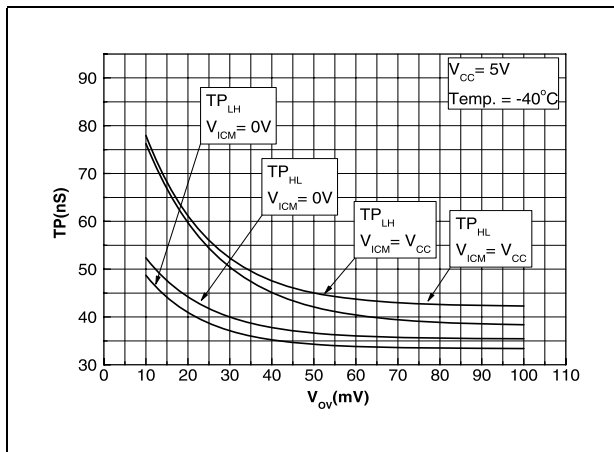

Figure 22. Propagation delay vs. overdrive
 $V_{CC}=5V$

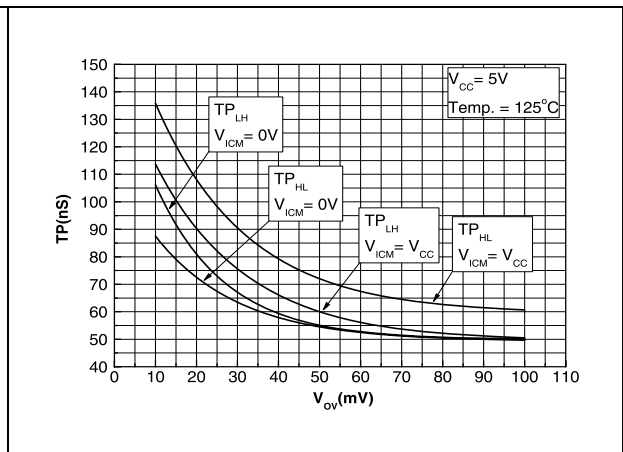

Figure 23. Propagation delay vs. temperature
 $V_{CC}=5V$, overdrive=100mV

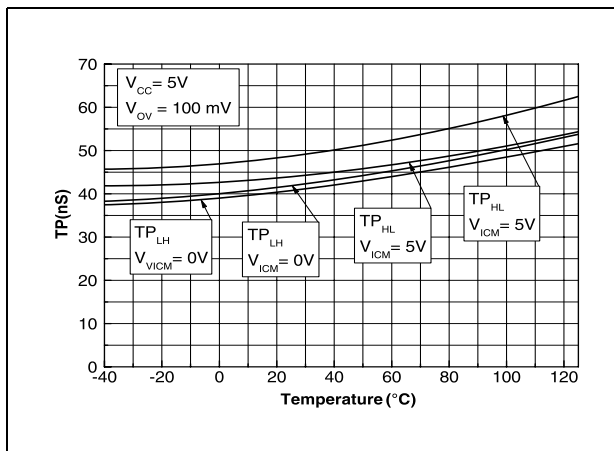
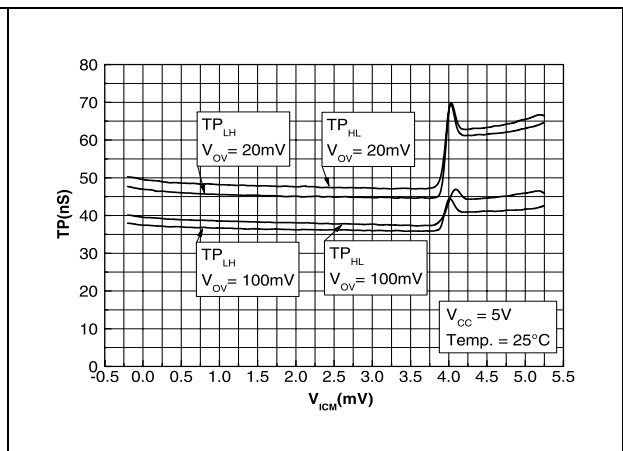

Figure 24. Propagation delay vs. common mode voltage, $V_{CC}=5V$



3 Package information

In order to meet environmental requirements, STMicroelectronics offers these devices in ECOPACK® packages. These packages have a lead-free second level interconnect. The category of second level interconnect is marked on the package and on the inner box label, in compliance with JEDEC Standard JESD97. The maximum ratings related to soldering conditions are also marked on the inner box label. ECOPACK is an STMicroelectronics trademark. ECOPACK specifications are available at: www.st.com.

3.1 SOT23-5 package mechanical data

Ref.	Dimensions					
	Millimeters			Mils		
	Min.	Typ.	Max.	Min.	Typ.	Max.
A	0.90		1.45	35.4		57.1
A1	0.00		0.15	0.00		5.9
A2	0.90		1.30	35.4		51.2
b	0.35		0.50	13.7		19.7
C	0.09		0.20	3.5		7.8
D	2.80		3.00	110.2		118.1
E	2.60		3.00	102.3		118.1
E1	1.50		1.75	59.0		68.8
e		0.95			37.4	
e1		1.9			74.8	
L	0.35		0.55	13.7		21.6

3.2 SC70-5 (SOT323-5) package mechanical data

Ref	Dimensions					
	Millimeters			Mils		
	Min	Typ	Max	Min	Typ	Max
A	0.80		1.10	31.5		43.3
A1	0.00		0.10	0.0		3.9
A2	0.80		1.00	31.5		39.4
b	0.15		0.30	5.9		11.8
C	0.10		0.18	3.9		7.1
D	1.80		2.20	70.9		86.6
E	1.80		2.40	70.9		94.5
E1	1.15		1.35	45.3		53.1
e		0.65			25.6	
e1		1.3			51.2	
L	0.10		0.30	3.9		11.8

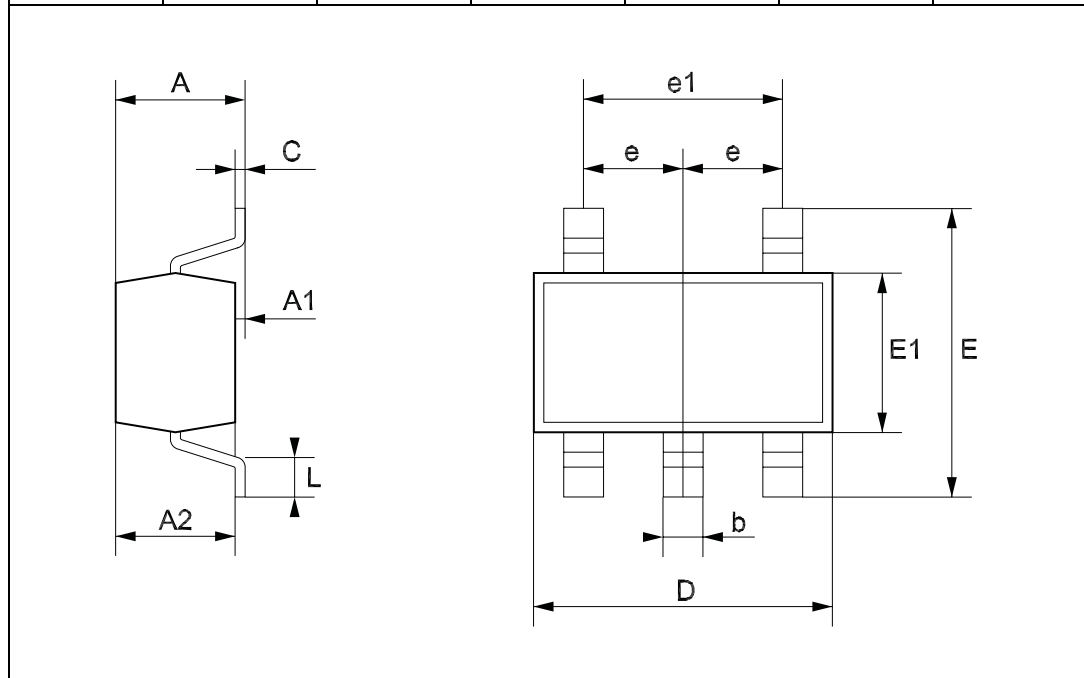

3.3 SO-8 package mechanical data

Ref.	Dimensions					
	Millimeters			Inches		
	Min.	Typ.	Max.	Min.	Typ.	Max.
A	1.35		1.75	0.053		0.069
A1	0.10		0.25	0.04		0.010
A2	1.10		1.65	0.043		0.065
B	0.33		0.51	0.013		0.020
C	0.19		0.25	0.007		0.010
D	4.80		5.00	0.189		0.197
E	3.80		4.00	0.150		0.157
e		1.27			0.050	
H	5.80		6.20	0.228		0.244
h	0.25		0.50	0.010		0.020
L	0.40		1.27	0.016		0.050
k	8° (max.)					
ddd			0.1			0.04

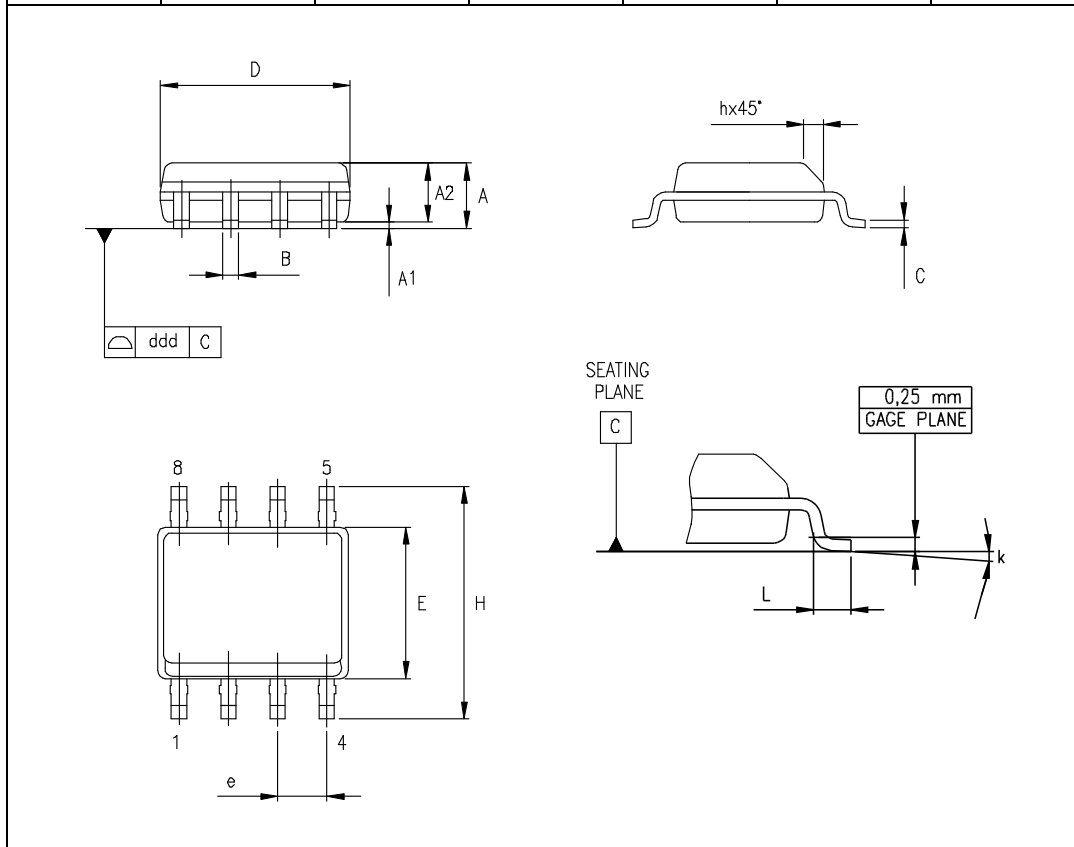

3.4 MiniSO-8 package mechanical data

Ref.	Dimensions					
	Millimeters			Inches		
	Min.	Typ.	Max.	Min.	Typ.	Max.
A			1.1			0.043
A1	0		0.15	0		0.006
A2	0.75	0.85	0.95	0.030	0.033	0.037
b	0.22		0.40	0.009		0.016
c	0.08		0.23	0.003		0.009
D	2.80	3.00	3.20	0.11	0.118	0.126
E	4.65	4.90	5.15	0.183	0.193	0.203
E1	2.80	3.00	3.10	0.11	0.118	0.122
e		0.65			0.026	
L	0.40	0.60	0.80	0.016	0.024	0.031
L1		0.95			0.037	
L2		0.25			0.010	
k	0°		8°	0°		8°
ccc			0.10			0.004

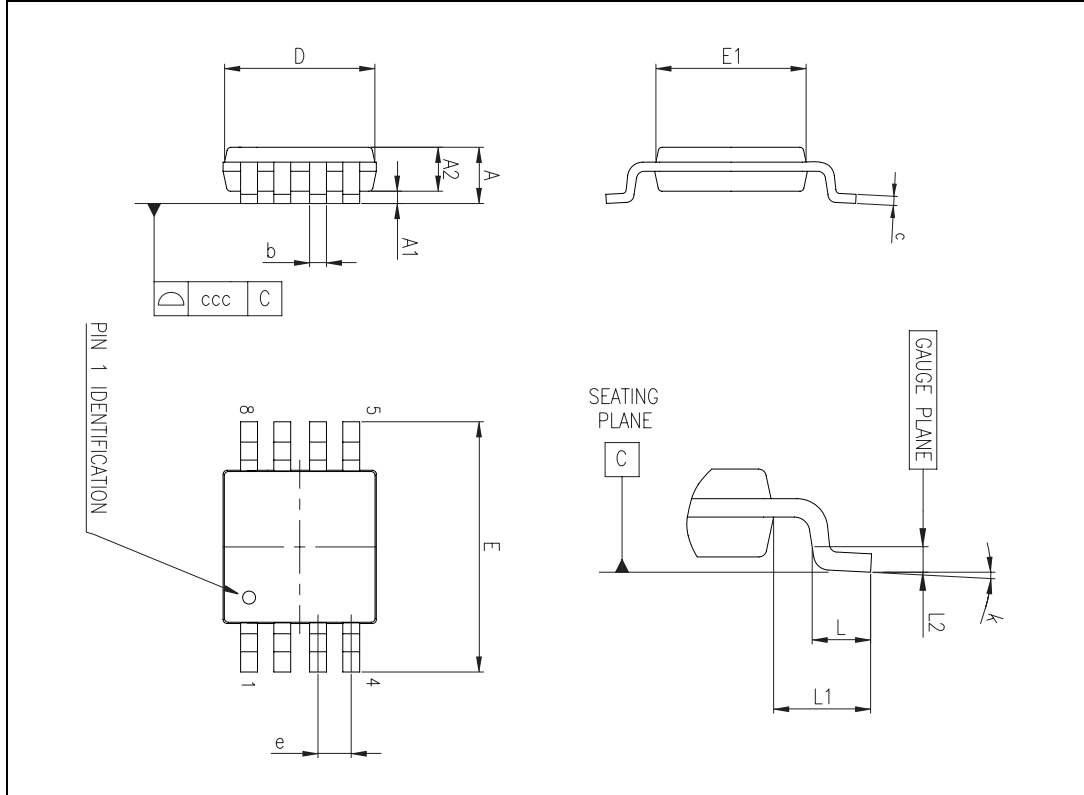

4 Ordering information

Table 6. Order codes

Part number	Temperature range	Package	Packaging	Marking
TS3021ILT	-40°C, +125°C	SOT23-5	Tape & reel	K520
TS3021ICT		SC70-5	Tape & reel	K52
TS3022ID		SO-8	Tube	3022I
TS3022IDT		SO-8	Tape & reel	3022I
TS3022IST		MiniSO-8	Tape & reel	K521

5 Revision history

Date	Revision	Changes
1-Jun-2006	1	Initial release.
1-Sep-2006	2	Dual version added. Pinout of single TS3021 corrected. Modified temperature range for input common mode voltage.
22-Feb-2007	3	Addition of MiniSO-8 package for dual version.
17-Oct-2007	4	Marking corrected for SO-8 package. Thermal resistance values corrected in AMR table. Notes on ESD added in AMR table.

Please Read Carefully:

Information in this document is provided solely in connection with ST products. STMicroelectronics NV and its subsidiaries ("ST") reserve the right to make changes, corrections, modifications or improvements, to this document, and the products and services described herein at any time, without notice.

All ST products are sold pursuant to ST's terms and conditions of sale.

Purchasers are solely responsible for the choice, selection and use of the ST products and services described herein, and ST assumes no liability whatsoever relating to the choice, selection or use of the ST products and services described herein.

No license, express or implied, by estoppel or otherwise, to any intellectual property rights is granted under this document. If any part of this document refers to any third party products or services it shall not be deemed a license grant by ST for the use of such third party products or services, or any intellectual property contained therein or considered as a warranty covering the use in any manner whatsoever of such third party products or services or any intellectual property contained therein.

UNLESS OTHERWISE SET FORTH IN ST'S TERMS AND CONDITIONS OF SALE ST DISCLAIMS ANY EXPRESS OR IMPLIED WARRANTY WITH RESPECT TO THE USE AND/OR SALE OF ST PRODUCTS INCLUDING WITHOUT LIMITATION IMPLIED WARRANTIES OF MERCHANTABILITY, FITNESS FOR A PARTICULAR PURPOSE (AND THEIR EQUIVALENTS UNDER THE LAWS OF ANY JURISDICTION), OR INFRINGEMENT OF ANY PATENT, COPYRIGHT OR OTHER INTELLECTUAL PROPERTY RIGHT.

UNLESS EXPRESSLY APPROVED IN WRITING BY AN AUTHORIZED ST REPRESENTATIVE, ST PRODUCTS ARE NOT RECOMMENDED, AUTHORIZED OR WARRANTED FOR USE IN MILITARY, AIR CRAFT, SPACE, LIFE SAVING, OR LIFE SUSTAINING APPLICATIONS, NOR IN PRODUCTS OR SYSTEMS WHERE FAILURE OR MALFUNCTION MAY RESULT IN PERSONAL INJURY, DEATH, OR SEVERE PROPERTY OR ENVIRONMENTAL DAMAGE. ST PRODUCTS WHICH ARE NOT SPECIFIED AS "AUTOMOTIVE GRADE" MAY ONLY BE USED IN AUTOMOTIVE APPLICATIONS AT USER'S OWN RISK.

Resale of ST products with provisions different from the statements and/or technical features set forth in this document shall immediately void any warranty granted by ST for the ST product or service described herein and shall not create or extend in any manner whatsoever, any liability of ST.

ST and the ST logo are trademarks or registered trademarks of ST in various countries.

Information in this document supersedes and replaces all information previously supplied.

The ST logo is a registered trademark of STMicroelectronics. All other names are the property of their respective owners.

© 2007 STMicroelectronics - All rights reserved

STMicroelectronics group of companies

Australia - Belgium - Brazil - Canada - China - Czech Republic - Finland - France - Germany - Hong Kong - India - Israel - Italy - Japan - Malaysia - Malta - Morocco - Singapore - Spain - Sweden - Switzerland - United Kingdom - United States of America

www.st.com