

# 6 PIN DIP PHOTOTRANSISTOR AC INPUT PHOTOCOUPLER

## H11AAX Series

### Features

- H11AAX series: H11AA1, H11AA2, H11AA3, H11AA4
- High isolation voltage between input and output  
Viso = 5000 Vrms
- Creepage distance >7.62 mm
- Compact dual-in-line package
- Pb free and RoHS compliant.
- UL approved (No. E214129)
- VDE approval pending
- SEMKO approval pending
- NEMKO approval pending
- DEMKO approval pending
- FIMKO approval pending
- CSA approval pending

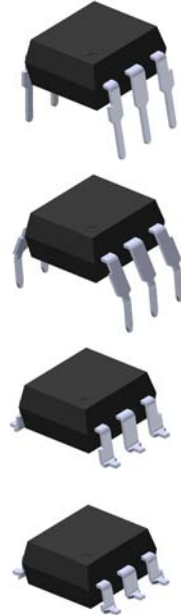

### Description

The H11AAX series of devices each consist of two infrared emitting diode, connected in inverse parallel, optically coupled to a phototransistor detector.

They are packaged in a 6-pin DIP package and available in wide-lead spacing and SMD option.

### Applications

- AC line monitor
- Unknown polarity DC sensor
- Telephone line interface

### Schematic

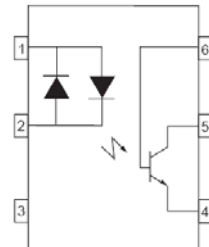

1. Anode / Cathode
2. Cathode / Anode
3. No Connection
4. Emitter
5. Collector
6. Base



LIGHTING FOREVER

# 6 PIN DIP PHOTOTRANSISTOR AC INPUT PHOTOCOUPLER

## H11AAX Series

### Absolute Maximum Ratings ( $T_a=25^{\circ}\text{C}$ )

Parameter		Symbol	Rating	Unit
Input	Forward current	$I_F$	60	mA
	Peak forward current ( $t = 10\mu\text{s}$ )	$I_{FM}$	1	A
	Power dissipation ( $T_A = 25^{\circ}\text{C}$ )	$P_D$	120	mW
	Derating factor (above $90^{\circ}\text{C}$ )		3.8	mW/ $^{\circ}\text{C}$
Output	Power dissipation ( $T_A = 25^{\circ}\text{C}$ ) No derating up to $100^{\circ}\text{C}$	$P_C$	150	mW
	Collector-Emitter voltage	$V_{CEO}$	80	V
	Collector-Base voltage	$V_{CBO}$	80	V
	Emitter-Collector voltage	$V_{ECO}$	7	V
Total power dissipation		$P_{tot}$	200	mW
Isolation voltage <sup>*1</sup>		$V_{iso}$	5000	V <sub>rms</sub>
Operating temperature		$T_{opr}$	-55~+100	$^{\circ}\text{C}$
Storage temperature		$T_{stg}$	-55~+125	$^{\circ}\text{C}$
Soldering temperature <sup>*2</sup>		$T_{sol}$	260	$^{\circ}\text{C}$

#### Notes

\*1 AC for 1 minute, R.H.= 40 ~ 60% R.H. In this test, pins 1, 2 & 3 are shorted together, and pins 4, 5 & 6 are shorted together.

\*2 For 10 seconds.

# 6 PIN DIP PHOTOTRANSISTOR AC INPUT PHOTOCOUPLER

## H11AAX Series

### Electrical Characteristics ( $T_a=25^\circ\text{C}$ unless specified otherwise)

#### Input

Parameter	Symbol	Min.	Typ.*	Max.	Unit	Condition
Forward voltage	$V_F$	-	1.2	1.5	V	$I_F = \pm 10\text{mA}$
Input capacitance	$C_{in}$	-	80	-	pF	$V = 0, f = 1\text{MHz}$

#### Output

Parameter	Symbol	Min.	Typ.*	Max.	Unit	Condition
Collector-Emitter dark current	$I_{CEO}$	-	-	50	nA	$V_{CE} = 10\text{V}, I_F = 0\text{mA}$
Collector-Emitter breakdown voltage	$BV_{CEO}$	80	-	-	V	$I_C = 1\text{mA}$
Collector-Base breakdown voltage	$BV_{CBO}$	80	-	-	V	$I_C = 0.1\text{mA}$
Emitter-Collector breakdown voltage	$BV_{ECO}$	7	-	-	V	$I_E = 0.1\text{mA}$
Collector-Emitter capacitance	$C_{CE}$	-	10	-	pF	$V_{CE} = 0\text{V}, f = 1\text{MHz}$

#### Transfer Characteristics

Parameter	Symbol	Min.	Typ.*	Max.	Unit	Condition	
Current Transfer Ratio	H11AA1	CTR	20	-	-	%	$I_F = \pm 10\text{mA}, V_{CE} = 10\text{V}$
	H11AA2		10	-	-		
	H11AA3		50	-	-		
	H11AA4		100	-	-		
CTR Symmetry		0.5	-	2.0		$I_F = \pm 10\text{mA}, V_{CE} = 10\text{V}$	
Collector-emitter saturation voltage	$V_{CE(sat)}$	-	-	0.4	V	$I_F = \pm 10\text{mA}, I_C = 0.5\text{mA}$	
Isolation resistance	$R_{IO}$	$10^{11}$	-	-	$\Omega$	$V_{IO} = 500\text{Vdc}$	
Input-output capacitance	$C_{IO}$	-	0.7	-	pF	$V_{IO} = 0, f = 1\text{MHz}$	
Turn-on time	$T_{on}$	-	-	10	$\mu\text{s}$	$V_{CC} = 10\text{V}, I_C = 10\text{mA}, R_L = 100\Omega$	
Turn-off time	$T_{off}$	-	-	10			
Rise time	$T_r$	-	-	10			
Fall time	$T_f$	-	-	10			

\* Typical values at  $T_a = 25^\circ\text{C}$



LIGHTING FOREVER

# 6 PIN DIP PHOTOTRANSISTOR AC INPUT PHOTOCOUPLER

## H11AAX Series

### Typical Performance Curves

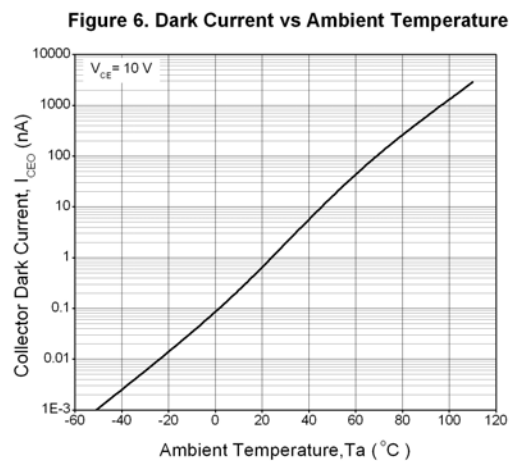
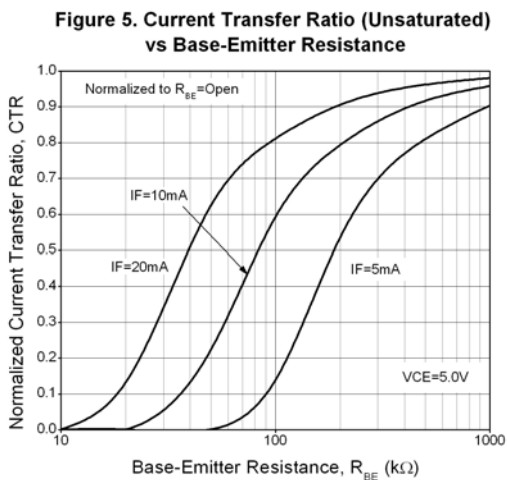
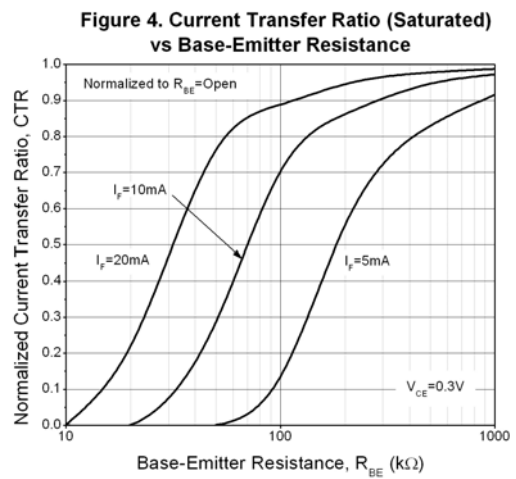
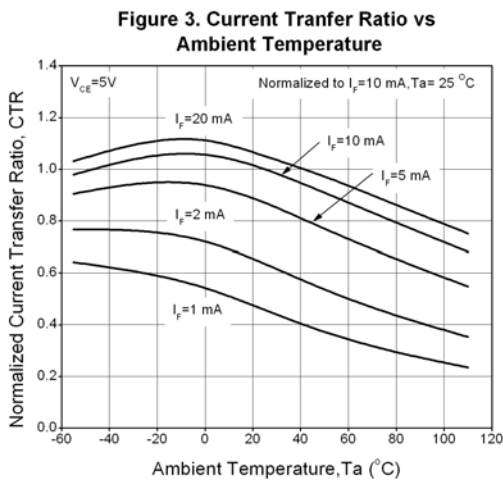
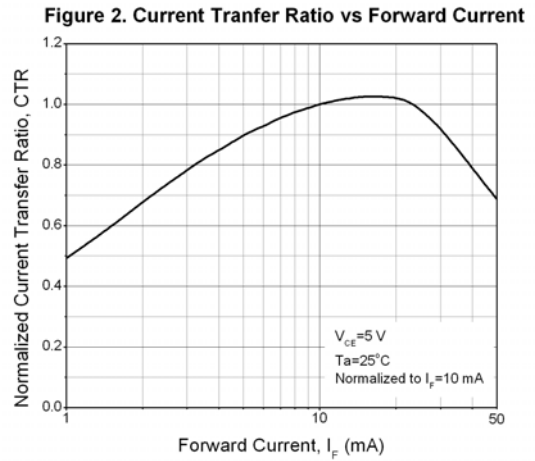
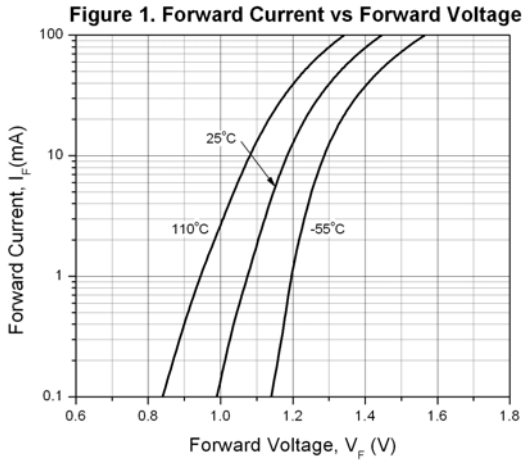

# 6 PIN DIP PHOTOTRANSISTOR AC INPUT PHOTOCOUPLER

## H11AAX Series

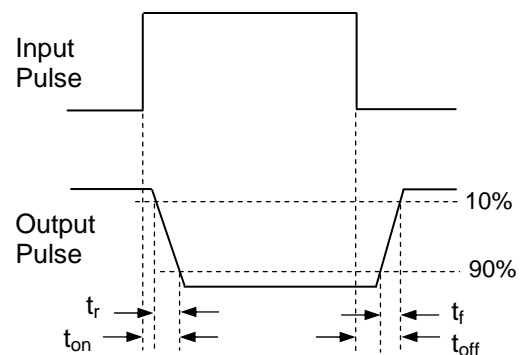
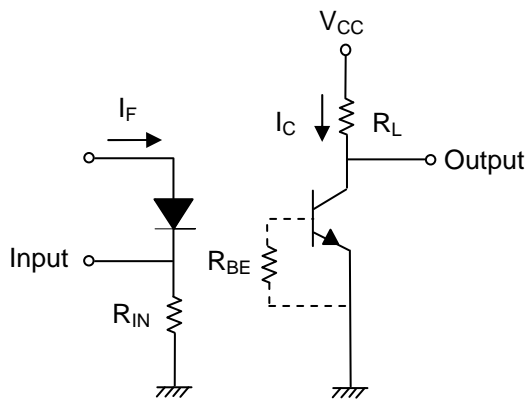
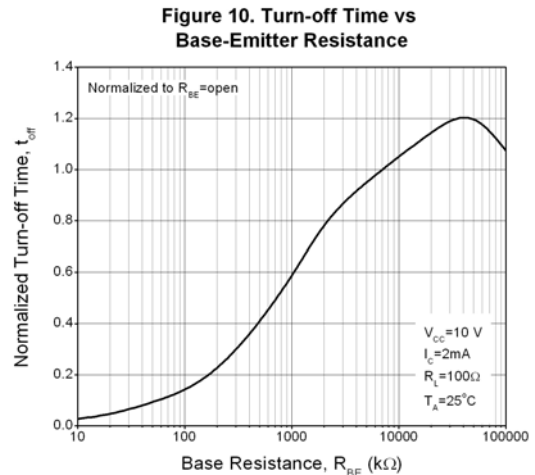
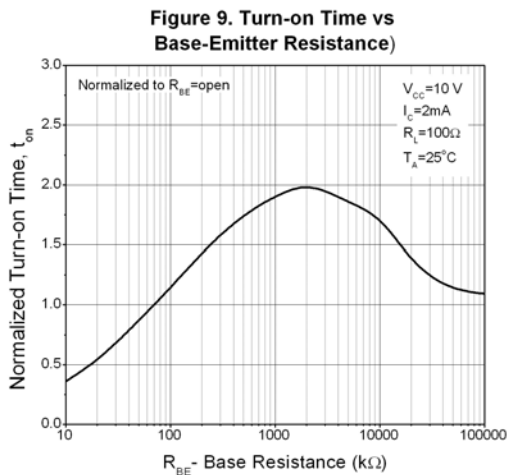
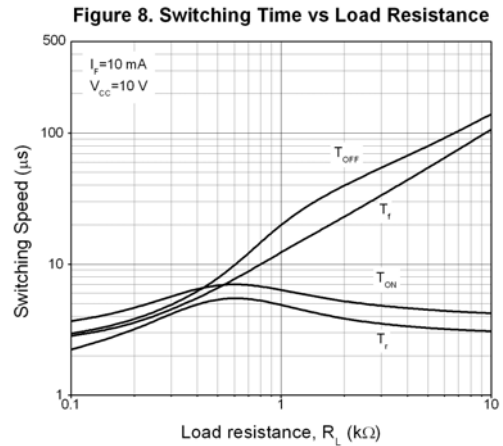
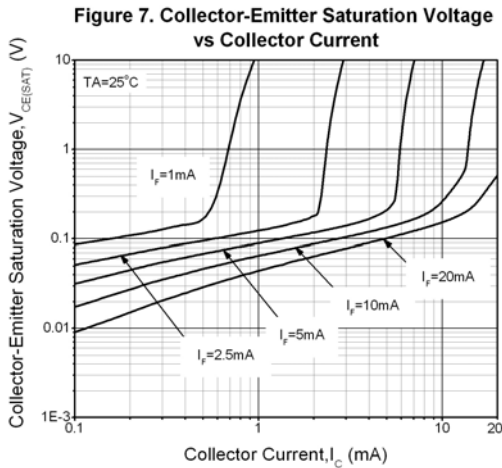

**Figure 11. Switching Time Test Circuit & Waveforms**



LIGHTING FOREVER

# 6 PIN DIP PHOTOTRANSISTOR AC INPUT PHOTOCOUPLER

## H11AAX Series

### Order Information

Part Number

# H11AAXY(Z)-V

Note

X = Part no. (1, 2, 3 or 4)

Y = Lead form option (S, S1, M or none)

Z = Tape and reel option (TA, TB or none).

V= VDE safety (optional)

Option	Description	Packing quantity
None	Standard DIP-6	65 units per tube
M	Wide lead bend (0.4 inch spacing)	65 units per tube
S (TA)	Surface mount lead form + TA tape & reel option	1000 units per reel
S (TB)	Surface mount lead form + TB tape & reel option	1000 units per reel
S1 (TA)	Surface mount lead form (low profile) + TA tape & reel option	1000 units per reel
S1 (TB)	Surface mount lead form (low profile) + TB tape & reel option	1000 units per reel



LIGHTING FOREVER

# 6 PIN DIP PHOTOTRANSISTOR AC INPUT PHOTOCOUPLER

## H11AAX Series

### Package Drawings

(Dimensions in mm)

#### Standard DIP Type

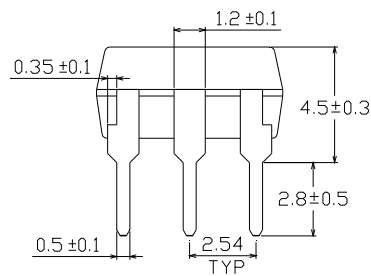
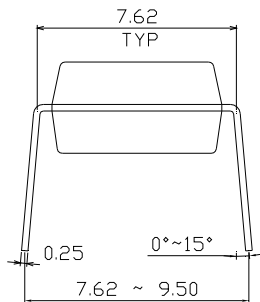
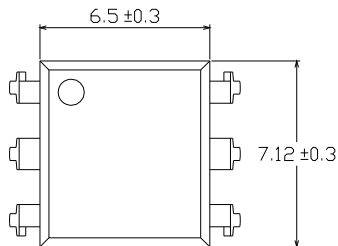

#### Option M Type

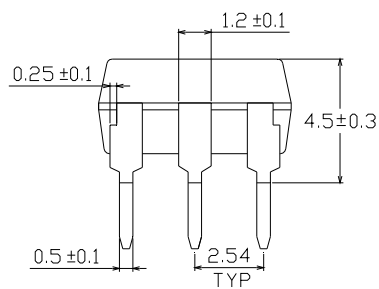
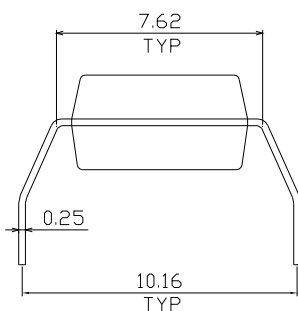
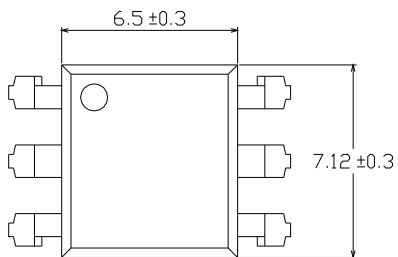



LIGHTING FOREVER

# 6 PIN DIP PHOTOTRANSISTOR AC INPUT PHOTOCOUPLER

## H11AAX Series

### Option S Type

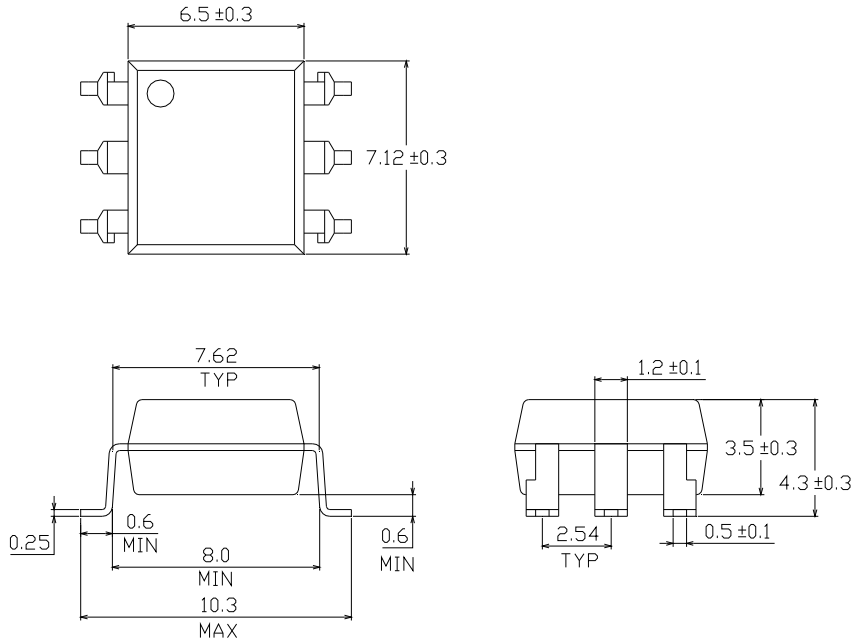

### Option S1 Type

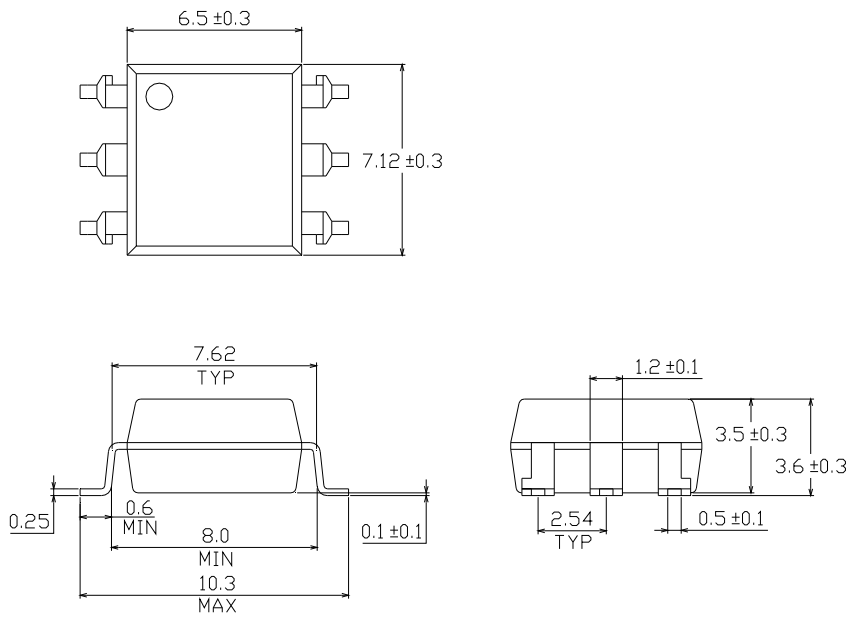





LIGHTING FOREVER

# 6 PIN DIP PHOTOTRANSISTOR AC INPUT PHOTOCOUPLER

## H11AAX Series

Recommended pad layout for surface mount leadform

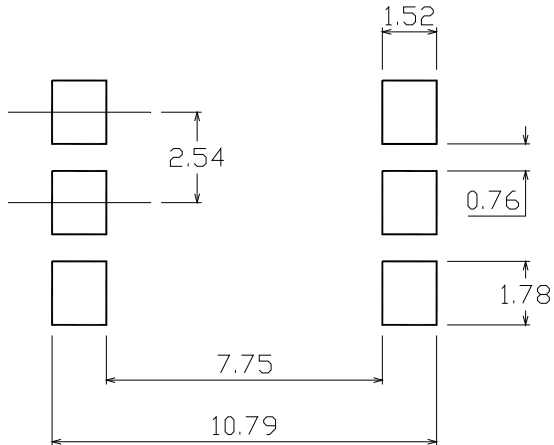

### Device Marking

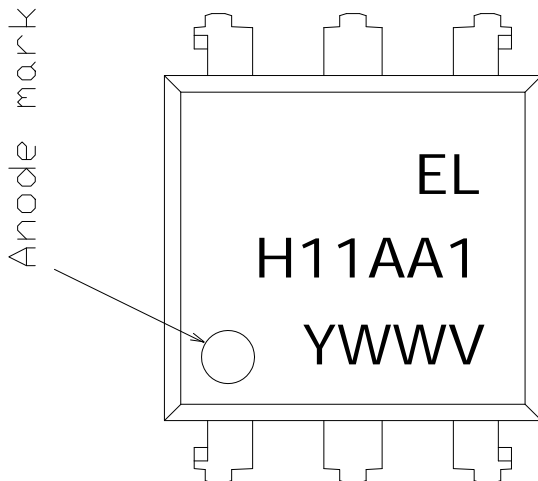

### Notes

- EL denotes Everlight
- H11AA1 denotes Part Number
- Y denotes 1 digit Year code
- WW denotes 2 digit Week code
- V denotes VED safety (optional)

# 6 PIN DIP PHOTOTRANSISTOR AC INPUT PHOTOCOUPLER

## H11AAX Series

### Tape & Reel Packing Specifications

**Option TA**

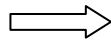
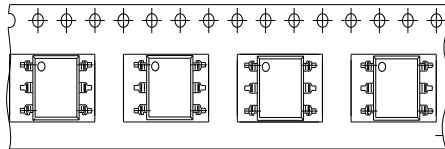

Direction of feed from reel

**Option TB**

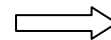
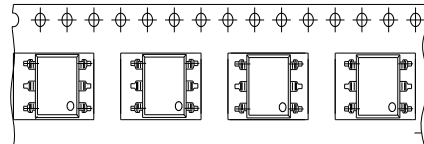

Direction of feed from reel

### Tape dimensions

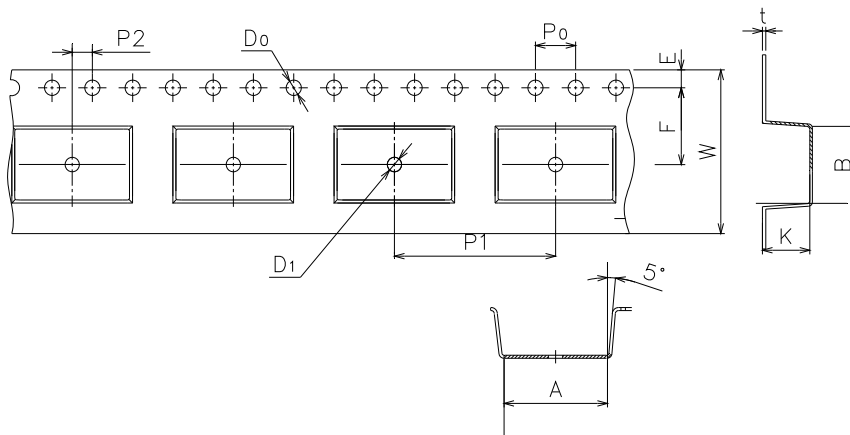

Dimension No.	A	B	Do	D1	E	F
Dimension (mm)	10.4±0.1	7.52±0.1	1.5±0.1	1.5+0.1/-0	1.75±0.1	7.5±0.1

Dimension No.	Po	P1	P2	t	W	K
Dimension (mm)	4.0±0.15	16.0±0.1	2.0±0.1	0.35±0.03	16.0±0.2	4.5±0.1



LIGHTING FOREVER

# 6 PIN DIP PHOTOTRANSISTOR AC INPUT PHOTOCOUPLER

## H11AAX Series

### Solder Reflow Temperature Profile

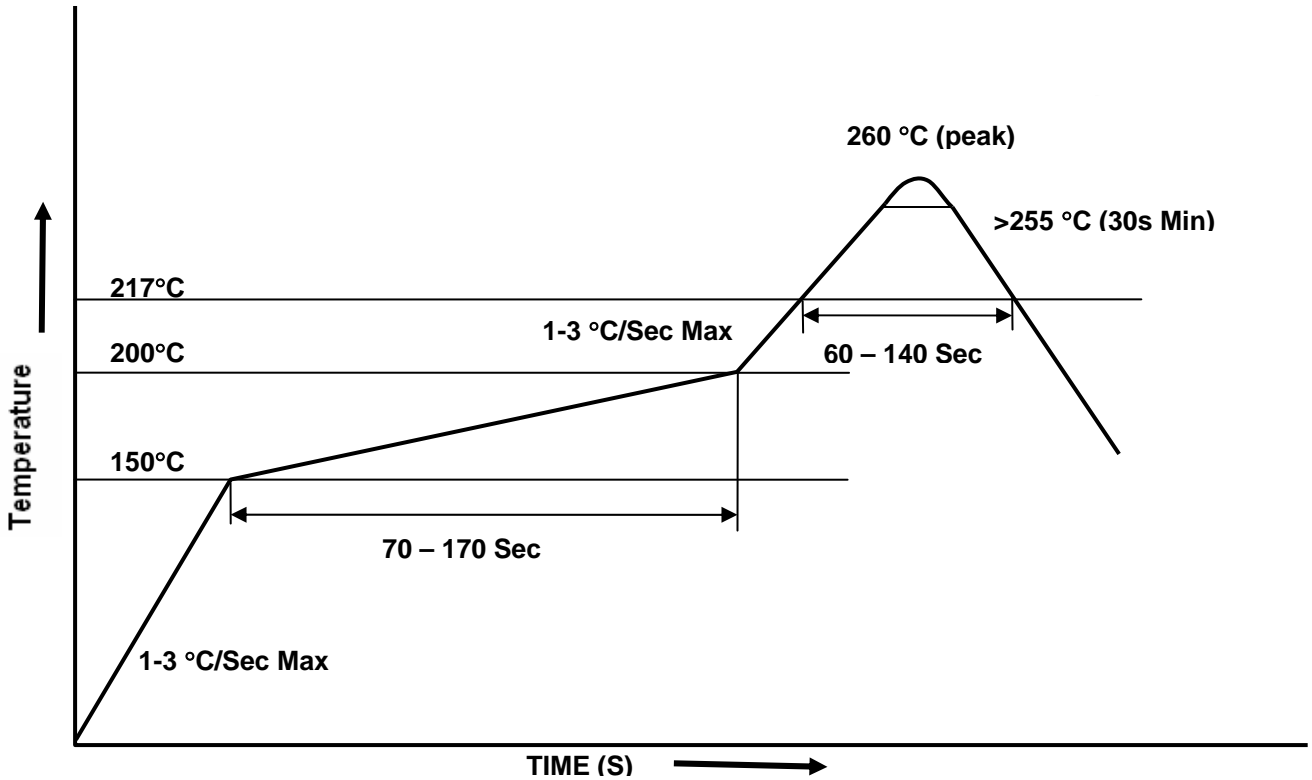



## 6 PIN DIP PHOTOTRANSISTOR AC INPUT PHOTOCOUPLER

**H11AAX Series**

---

### DISCLAIMER

1. Above specification may be changed without notice. EVERLIGHT will reserve authority on material change for above specification.
2. When using this product, please observe the absolute maximum ratings and the instructions for use outlined in these specification sheets. EVERLIGHT assumes no responsibility for any damage resulting from use of the product which does not comply with the absolute maximum ratings and the instructions included in these specification sheets.

These specification sheets include materials protected under copyright of EVERLIGHT. Reproduction in any form is prohibited without the specific consent of EVERLIGHT.