

1.224V Open Collector Shunt Voltage Reference

- Internal 1.224V $\pm 0.5\%$ precision
- Low output saturation voltage
75 mV max between SINK and GND
- Low current consumption: 250 μ A
- Industrial temperature range: -40 to +85°C
- 100ppm/°C temperature coefficient

Description

The TS4431 is a four-terminal device dedicated to low voltage Switch Mode Power Supplies (SMPS).

It integrates a 1.224V voltage reference, an amplifier, and an open collector output transistor in a single package. The TS4431's operating mode is similar to the well-known standard voltage reference, the TL431. It maintains the desired feedback voltage at the REF pin in a closed loop configuration by sinking a current proportional to the error voltage at the REF pin.

TS4431 features an open collector transistor with an ultra-low saturation voltage, allowing it to be used in series with the optocoupler in an SMPS architecture to regulate low voltage SMPS.

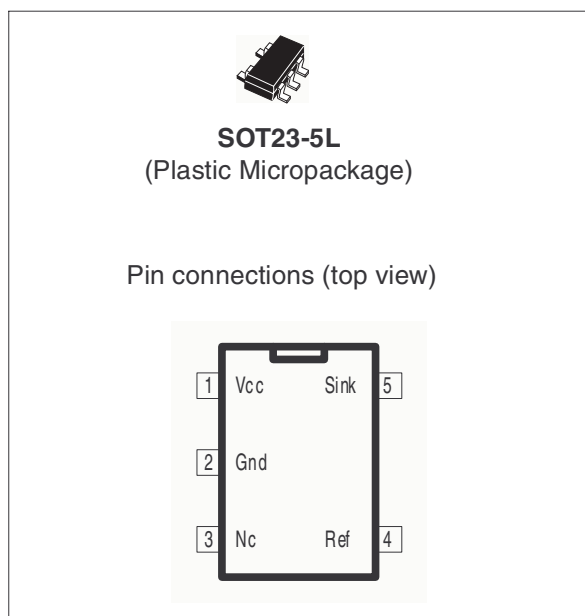

Applications

- Low voltage switch mode power supplies
- Isolated DC/DC converter
- Computers
- Low voltage discrete regulator

Order Codes

Part Number	Accuracy	Temperature Range	Package	Packing	Marking
TS4431AILT	0.5%	-40, +85°C	SOT23-5	Tape & Reel	L288
TS4431ILT	1%				L275

1 Absolute Maximum Ratings

Table 1. Key parameters and their absolute maximum ratings

Symbol	Parameter	Value	Unit
I_{SINK}	Output sink current	30	mA
V_{CC}	Supply voltage	12	V
V_{SINK}	Output voltage	12	V
P_D	Power Dissipation ⁽¹⁾ SOT23-5	500	mW
T_{STD}	Storage Temperature	-65 to +150	°C
ESD	Human Body Model (HBM)	2	kV
	Machine Model (MM)	200	V
T_{LEAD}	Lead Temperature (soldering, 10 seconds)	250	°C

1. P_D has been calculated with $T_{AMB} = 25^{\circ}\text{C}$, $T_{Junction} = 150^{\circ}\text{C}$ and
 $R_{thJA} = 250^{\circ}\text{C/W}$ for the SOT23-5 package
 $R_{thJC} = 81^{\circ}\text{C/W}$ for the SOT23-5 package

Table 2. Operating conditions

Symbol	Parameter	Value	Unit
T_{OPER}	Operating temperature range	-40 to +85	°C
V_{CC}	Supply voltage	1.5 to 10	V
I_{SINK}	Output sink current	20	mA

2 Typical Application Schematic

Figure 1. SMPS power supply: secondary side

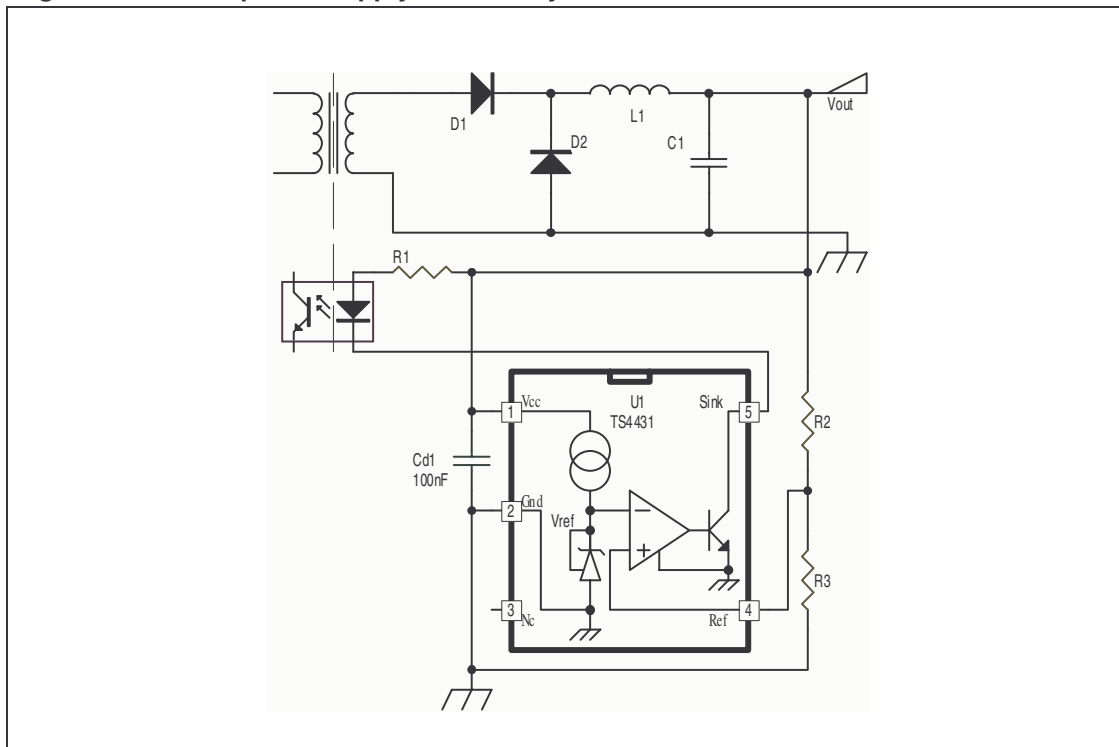

3 Electrical Characteristics

Table 3. Electrical characteristics for $T_{amb} = 25^{\circ}\text{C}$, $V_{CC} = 1.8\text{V}$, $I_{SINK} = 2\text{mA}$ unless otherwise specified

Symbol	Parameter	Test Condition	Min.	Typ.	Max.	Unit
V_{REF}	Reference voltage TS4431A 0.5%		1.218	1.224	1.230	V
		$-40^{\circ}\text{C} < T < +85^{\circ}\text{C}$	1.209		1.239	
V_{REF}	Reference voltage TS4431 1%		1.212	1.224	1.236	V
		$-40^{\circ}\text{C} < T < +85^{\circ}\text{C}$	1.203		1.245	
T_C	Temperature coefficient				100	ppm/ $^{\circ}\text{C}$
$\frac{\Delta V_{REF}}{\Delta V_{CC}}$	Change in V_{REF} due to change in V_{CC}	$V_{CC}=1.5$ to 10V		1	2	mV
		$-40^{\circ}\text{C} < T < +85^{\circ}\text{C}$		2	3	
$\frac{\Delta V_{REF}}{\Delta I_{SINK}}$	Change in V_{REF} due to change in I_{SINK}	$I_{SINK}=0.5$ to 20mA		7	10	mV
		$-40^{\circ}\text{C} < T < +85^{\circ}\text{C}$			15	
I_{CC}	Supply current	$I_{SINK}=2\text{mA}$		250	300	μA
		$-40^{\circ}\text{C} < T < +85^{\circ}\text{C}$			350	
I_{OFF}	OFF-State supply current	Ref $< 0.6\text{V}$		15	20	μA
		$-40^{\circ}\text{C} < T < +85^{\circ}\text{C}$			30	
I_{REF}	Reference input current	$0.1 < I_{SINK} < 10\text{mA}$		0.4	1	μA
		$-40^{\circ}\text{C} < T < +85^{\circ}\text{C}$			2	
V_{SAT}	Output transistor saturation voltage	$I_{SINK}=5\text{mA}$		30	50	mV
		$-40^{\circ}\text{C} < T < +85^{\circ}\text{C}$			60	
		$I_{SINK}=20\text{mA}$		90	100	
		$-40^{\circ}\text{C} < T < +85^{\circ}\text{C}$			120	
I_{OH}	Output leakage current	$V_{SINK}=V_{CC}$			0.05	μA
		$-40^{\circ}\text{C} < T < +85^{\circ}\text{C}$			0.1	

Note: Limits are 100% production tested at 25°C. Limits over temperature are guaranteed through correlation and by design.

Figure 2. Vref vs. temp. Isink=2mA

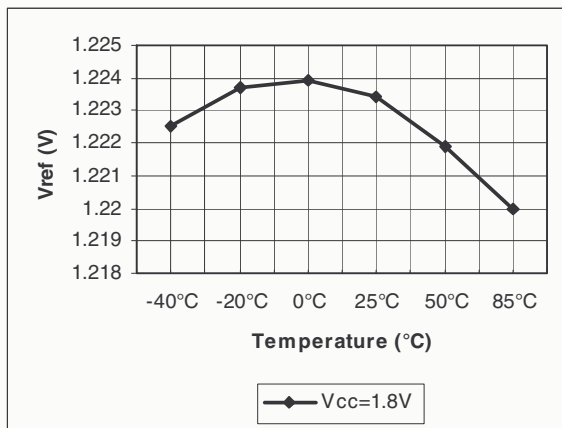

Figure 3. Vref vs. temp. Isink=2mA

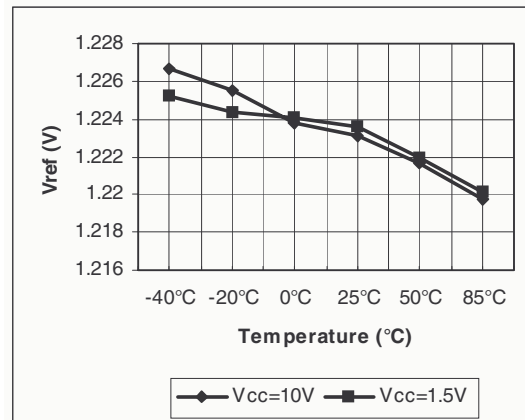

Figure 4. dVref/dVcc vs. temp. Isink=2mA

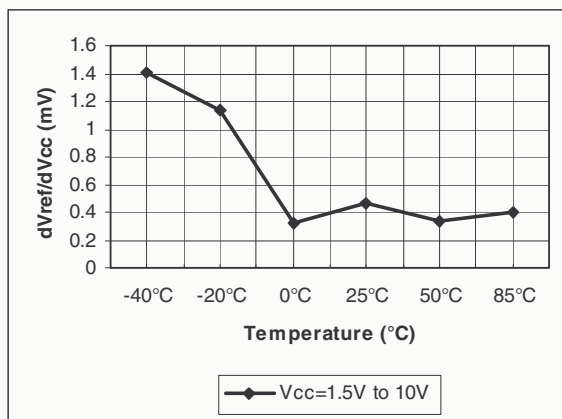

Figure 5. Icc vs. temp. Isink=2mA

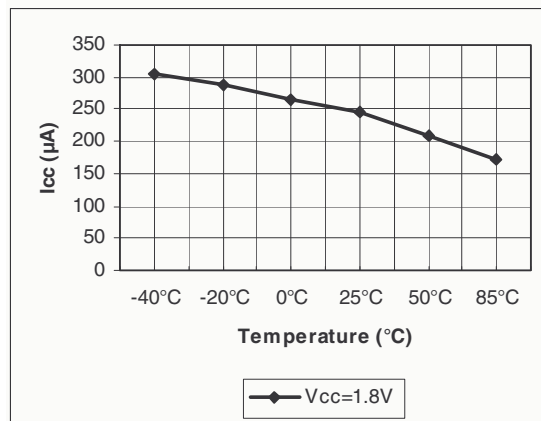

Figure 6. Icc vs. temp. Isink=2mA

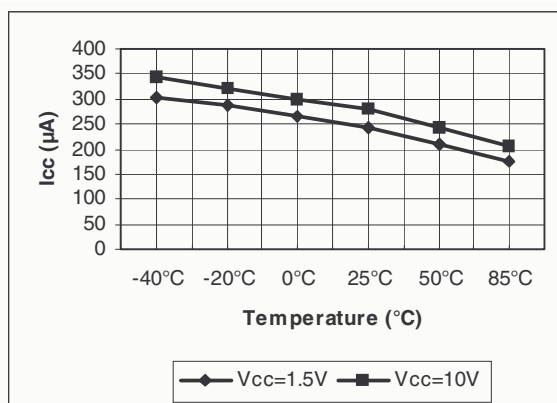

Figure 7. Vref vs. temp. Vcc=1.8V

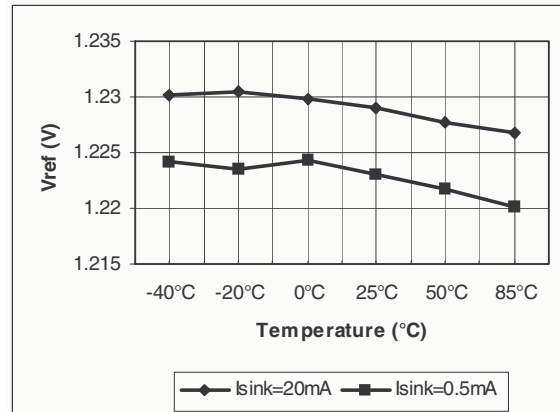

Figure 8. dV_{ref}/dI_{sink} vs. temp. $V_{cc}=1.8V$

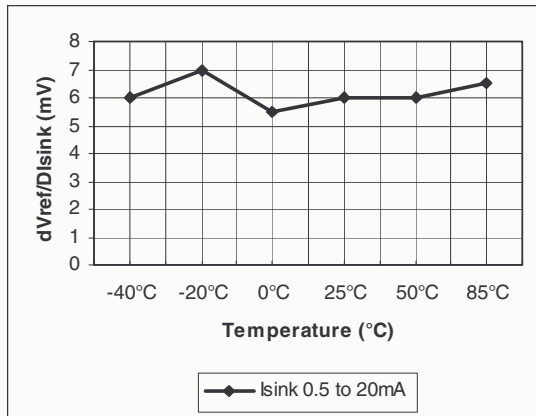

Figure 9. I_{ref} vs. temp. $V_{cc}=1.8V$

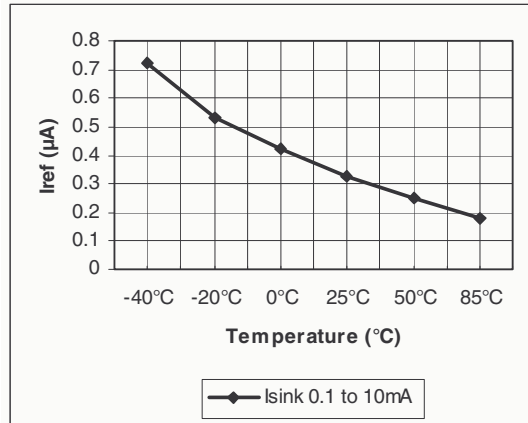
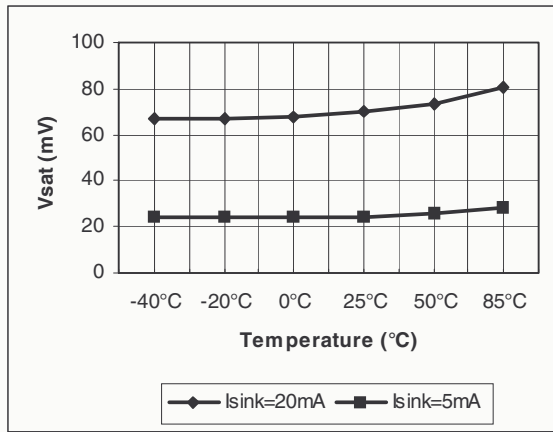

Figure 10. V_{sat} vs. temp. $V_{cc}=1.8V$



4 Package Mechanical Data

In order to meet environmental requirements, ST offers these devices in ECOPACK[®] packages. These packages have a Lead-free second level interconnect. The category of second level interconnect is marked on the package and on the inner box label, in compliance with JEDEC Standard JESD97. The maximum ratings related to soldering conditions are also marked on the inner box label. ECOPACK is an ST trademark. ECOPACK specifications are available at: www.st.com.

SOT23-5L Package

SOT23-5L MECHANICAL DATA						
DIM.	mm.			mils		
	MIN.	TYP.	MAX.	MIN.	TYP.	MAX.
A	0.90		1.45	35.4		57.1
A1	0.00		0.15	0.0		5.9
A2	0.90		1.30	35.4		51.2
b	0.35		0.50	13.7		19.7
C	0.09		0.20	3.5		7.8
D	2.80		3.00	110.2		118.1
E	2.60		3.00	102.3		118.1
E1	1.50		1.75	59.0		68.8
e		0.95			37.4	
e1		1.9			74.8	
L	0.35		0.55	13.7		21.6

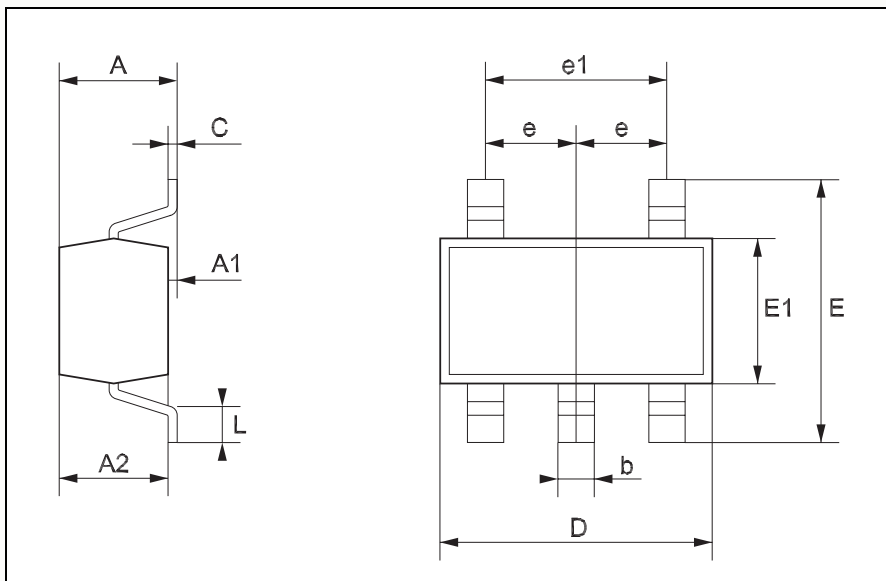

5 Revision History

Date	Revision	Changes
March 2005	1	First release corresponding to Preliminary Data version of datasheet.
Nov. 2005	2	First release of fully mature product data sheet.

Information furnished is believed to be accurate and reliable. However, STMicroelectronics assumes no responsibility for the consequences of use of such information nor for any infringement of patents or other rights of third parties which may result from its use. No license is granted by implication or otherwise under any patent or patent rights of STMicroelectronics. Specifications mentioned in this publication are subject to change without notice. This publication supersedes and replaces all information previously supplied. STMicroelectronics products are not authorized for use as critical components in life support devices or systems without express written approval of STMicroelectronics.

The ST logo is a registered trademark of STMicroelectronics.
All other names are the property of their respective owners

© 2005 STMicroelectronics - All rights reserved

STMicroelectronics group of companies

Australia - Belgium - Brazil - Canada - China - Czech Republic - Finland - France - Germany - Hong Kong - India - Israel - Italy - Japan - Malaysia - Malta - Morocco - Singapore - Spain - Sweden - Switzerland - United Kingdom - United States of America

www.st.com