

# 1N483B

## FEATURES

- 1N483B AVAILABLE IN JAN, JANTX, AND JANTXV PER MIL-PRF-19500/118
- SWITCHING DIODE
- METALLURGICALLY BONDED
- HERMETICALLY SEALED
- DOUBLE PLUG CONSTRUCTION
- ALSO AVAILABLE AS 1N483 & 1N483A

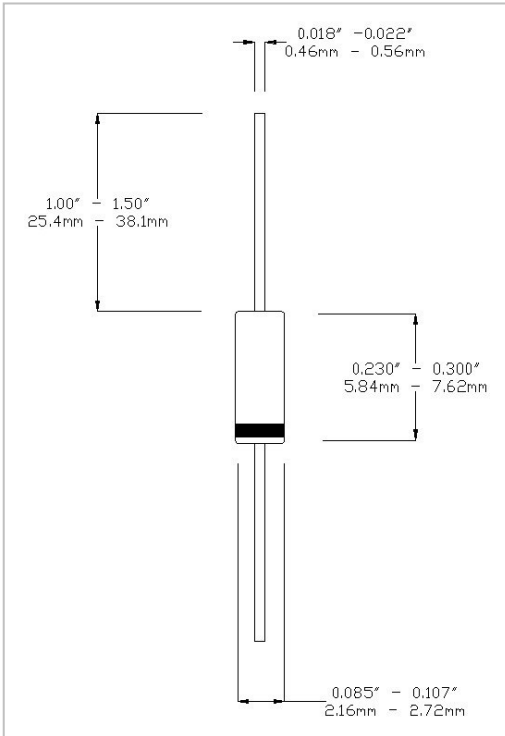

## MAXIMUM RATINGS AT 25 °C

Operating Temperature:	-65°C to +175°C
Storage Temperature:	-65°C to +175°C
Surge Current, sine, 8.3mS:	2A
Total Power Dissipation, 25°C:	500mW
Power Derating Factor, 25°C:	3mW/°C
Max. Operating Current, 25°C:	200mA
Derating Factor:	1.2mA/°C above T <sub>A</sub> = +25°C
Max. Operating Current, 150°C:	50mA
Derating Factor:	1.0mA/°C above T <sub>A</sub> = +150°C
D.C. Reverse Voltage (VRWM):	70V

## DESIGN DATA

**Case:** Hermetically sealed glass package per MIL-PRF-19500/118 DO-7 outline

**Lead Material:** Copper clad steel

**Lead Finish:** Tin/Lead

**Thermal Impedance (Z<sub>θJX</sub>):** 70°C/W maximum

**Marking:** Blue body coat, black digits

**Polarity:** Cathode end is banded

## DC ELECTRICAL CHARACTERISTICS

V <sub>F</sub>				I <sub>R</sub>			
Ambient (°C)	I <sub>F</sub> mA	Min V	Max V	Ambient (°C)	V (dc)	Min μA	Max μA
25	100	0.8	1.0	25	70	-	0.025
-55	100	-	1.2	25	80	-	100
				150	70	-	5.0



WWW.MICROSEMI.COM

IRELAND - GORT ROAD, ENNIS, CO. CLARE

PHONE: +353 65 6840044  
TOLL FREE: +186 62 702434  
FAX: +353 65 6822298

U.S.A. DOMESTIC SALES CONTACT

PHONE: (617) 926 0404  
TOLL FREE: 1 800 666 2999