

Linear IC Converter

CMOS

D/A Converter for Digital Tuning (12-channel, 8-bit, on-chip OP amp, low-voltage)

MB88346L

■ DESCRIPTION

The Fujitsu Microelectronics MB88346L is a 12-channel 8-bit D/A converter capable of low-voltage operation that has amplifiers built into each of the 12 analog output lines to deliver heavy-current drive capability.

The use of serial data input means that only three control lines are required, and enables cascade connection of multiple MB88346L chips.

The MB88346L is suitable for applications such as electronic volume controls and replacing trimmer potentiometers in tuning systems. In addition, the MB88346L is both function-compatible and pin-compatible the currently used MB88346B, making it easy to reduce the voltage level of a system by simply replacing the MB88346B with the MB88346L.

■ FEATURES

- Low voltage operation (V_{CC}/V_{DD} : 2.7 V to 3.6 V)
- Ultra-low power consumption (0.5 mW/ch at $V_{CC} = 3$ V)
- Ultra-compact space-saving package lineup (SSOP-20)
- Contains 12-channel R-2R type 8-bit D/A converter
- On-chip analog output amps (sink current max. 1.0 mA, source current max. 1.0 mA)
- Analog output range from 0 to V_{CC}
- Two separate power supply/ground lines for MCU interface block/operational amplifier output buffer block and D/A converter block
- Serial data input : maximum operating speed 2.5 MHz
(maximum operating speed in cascade connection is 1.5 MHz)
- CMOS process
- Package lineup includes DIP 20-pin, SSOP 20-pin

MB88346L

■ PIN ASSIGNMENT

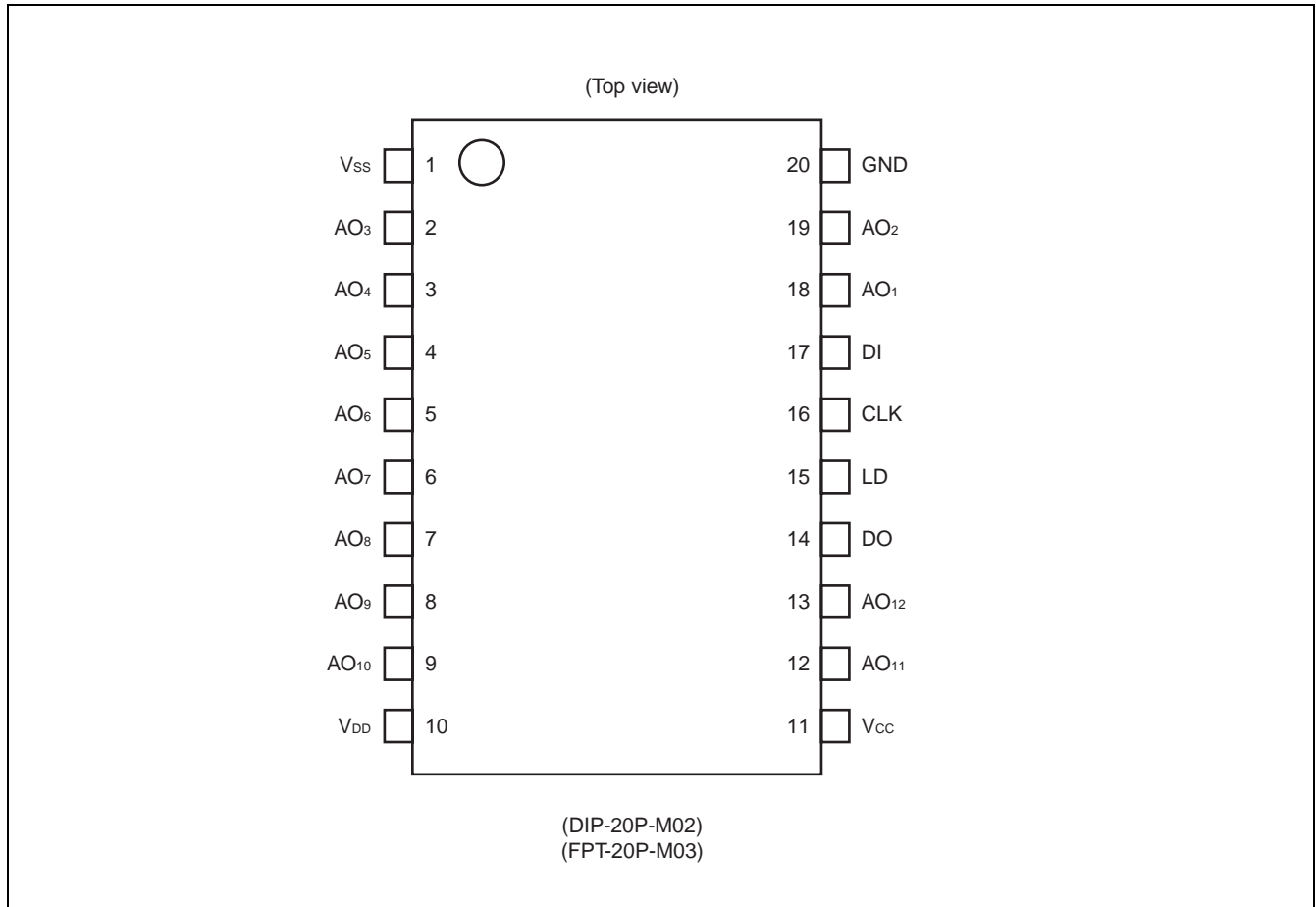

■ PIN DESCRIPTION

Pin No.	Symbol	I/O	Function
17	DI	I	Serial address/data input to the internal 12-bit shift register : The address/data format is that upper 4 bits (D11 to D8) indicate an address and lower 8 bits (D7 to D0) indicate data. The D11 (MSB) is the first-in bit and D0 (LSB) is the last-in bit.
14	DO	O	Outputs MSB bit data from 12-bit shift register.
16	CLK	I	Shift clock input to the internal 12-bit shift register : At the rising edge of CLK data on the DI pin is shifted into the LSB of the shift register and contents of the shift register are shifted right (to the MSB) .
15	LD	I	Load strobe input for a 12-bit address/data : A high level on the LD pin latches a 4-bit address (upper 4 bits : D11 to D8) of the internal 12-bit shift register into the internal address decoder, and writes 8-bit data (lower 8 bits : D7 to D0) of the shift register into an internal data latch selected by the latched address.
18 19 2 3 4 5 6 7 8 9 12 13	AO ₁ AO ₂ AO ₃ AO ₄ AO ₅ AO ₆ AO ₇ AO ₈ AO ₉ AO ₁₀ AO ₁₁ AO ₁₂	O	8-bit D/A output pins with OP amps.
11	V _{CC}	—	MCU interface and OP amp power supply pin.
20	GND	—	MCU interface and OP amp ground pin.
10	V _{DD}	—	D/A converter power supply pin.
1	V _{SS}	—	D/A converter ground pin.

MB88346L

■ BLOCK DIAGRAM

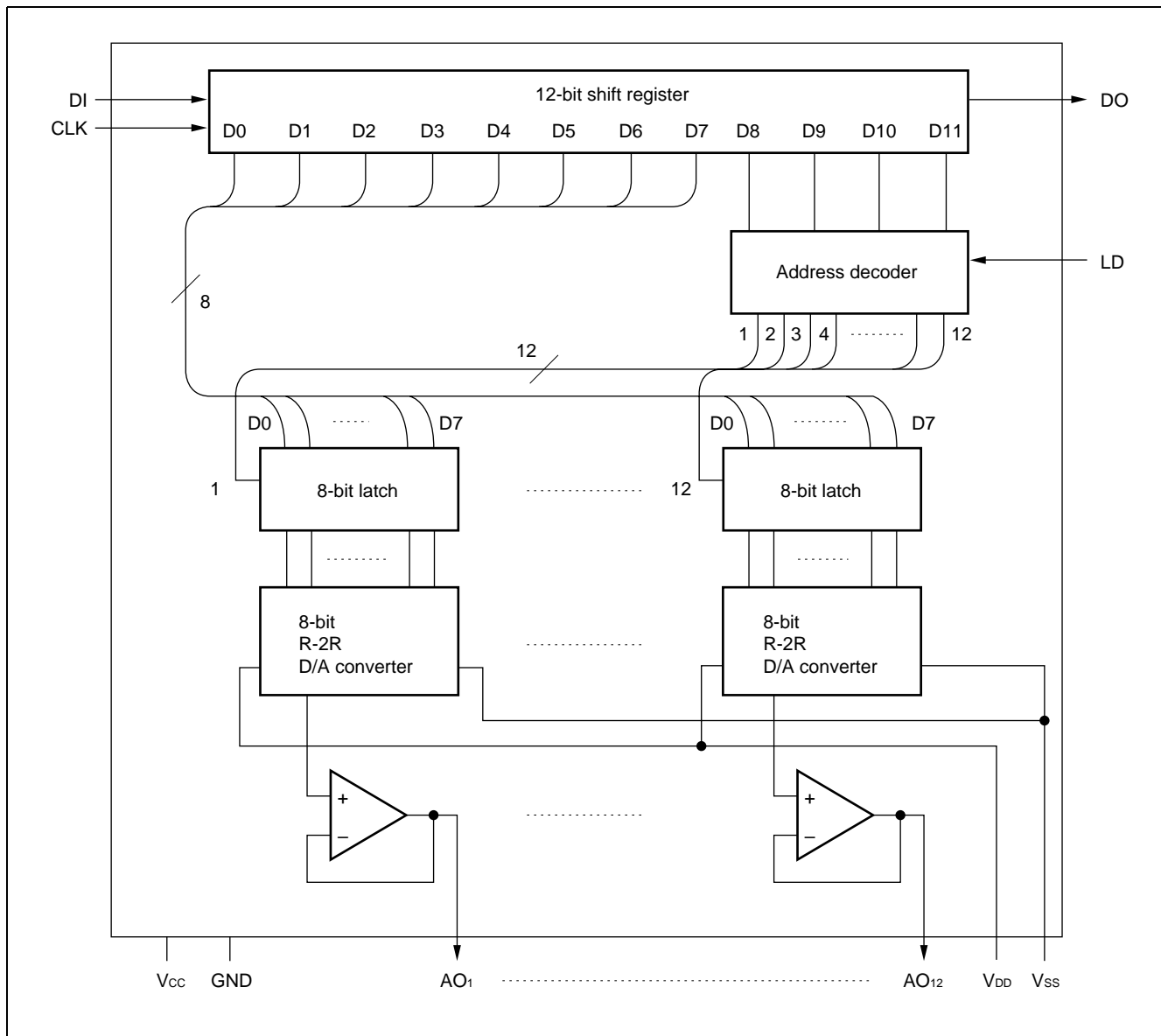

■ DATA CONFIGURATION

The MB88346L has a 12-bit shift register for controlling the chip. The data passed to the 12-bit shift register needs to be supplied in the following format.

The data structure consists of a total of 12 bits, four for address selection and eight for D/A data output.

1. Shift Register Control Data Configuration

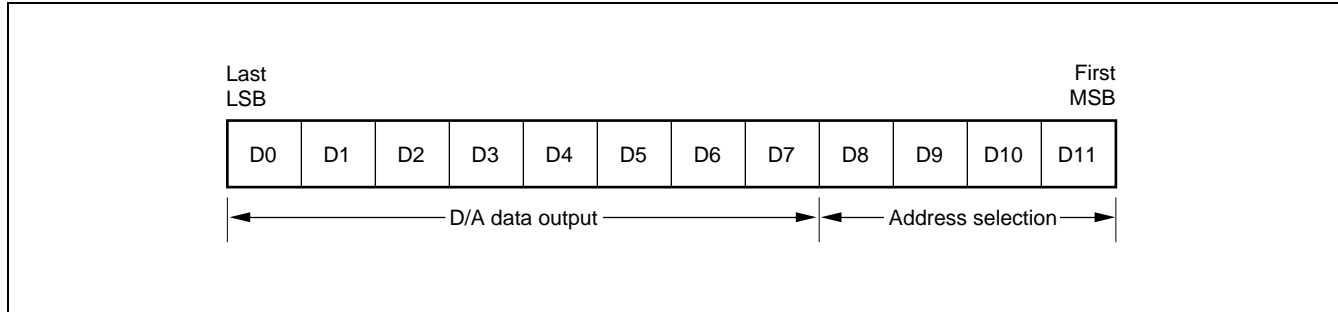

2. D/A Converter Control Signals

D0	D1	D2	D3	D4	D5	D6	D7	D/A data output
0	0	0	0	0	0	0	0	$\div V_{SS}$
1	0	0	0	0	0	0	0	$\div V_{LB} + V_{SS}$
0	1	0	0	0	0	0	0	$\div V_{LB} \times 2 + V_{SS}$
⋮	⋮	⋮	⋮	⋮	⋮	⋮	⋮	⋮
0	1	1	1	1	1	1	1	$\div V_{LB} \times 254 + V_{SS}$
1	1	1	1	1	1	1	1	$\div V_{DD}$

$$V_{LB} = (V_{DD} - V_{SS}) / 255$$

3. Address Selection Signals

D8	D9	D10	D11	Address selection
0	0	0	0	Don't Care
0	0	0	1	AO ₁ selection
0	0	1	0	AO ₂ selection
0	0	1	1	AO ₃ selection
0	1	0	0	AO ₄ selection
0	1	0	1	AO ₅ selection
0	1	1	0	AO ₆ selection
0	1	1	1	AO ₇ selection
1	0	0	0	AO ₈ selection
1	0	0	1	AO ₉ selection
1	0	1	0	AO ₁₀ selection
1	0	1	1	AO ₁₁ selection
1	1	0	0	AO ₁₂ selection
1	1	0	1	Don't Care
1	1	1	0	Don't Care
1	1	1	1	Don't Care

■ OPERATING DESCRIPTION

1. Timing Chart for Data Condition Setup

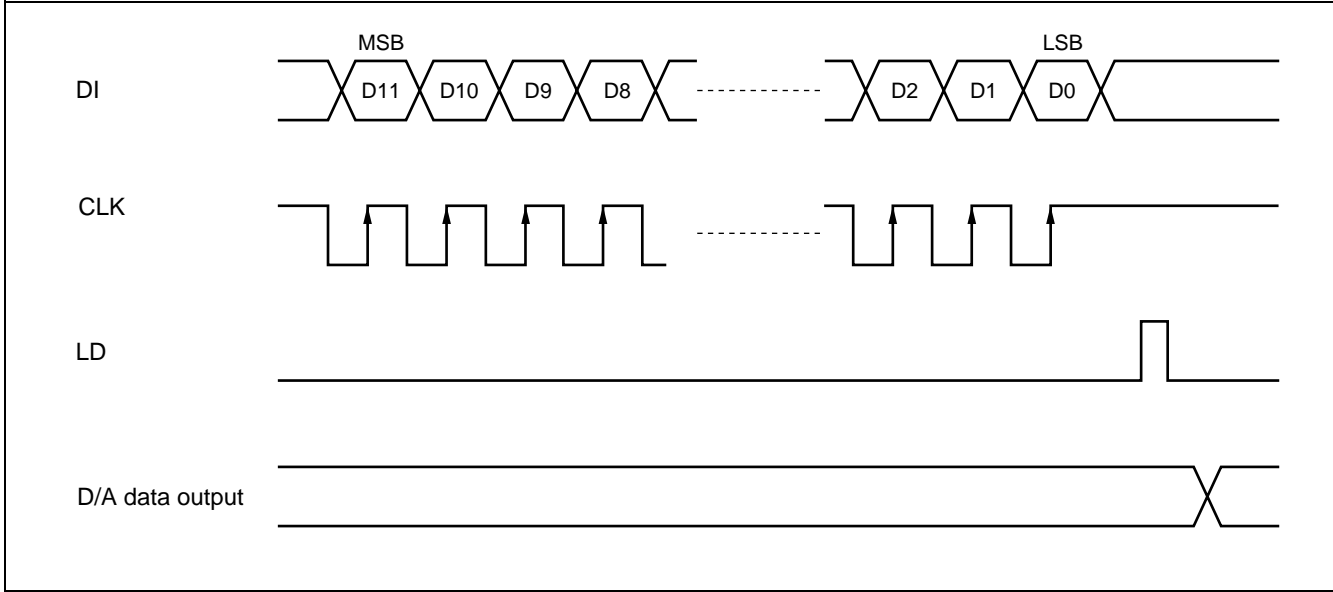

2. Analog Output Voltage Range

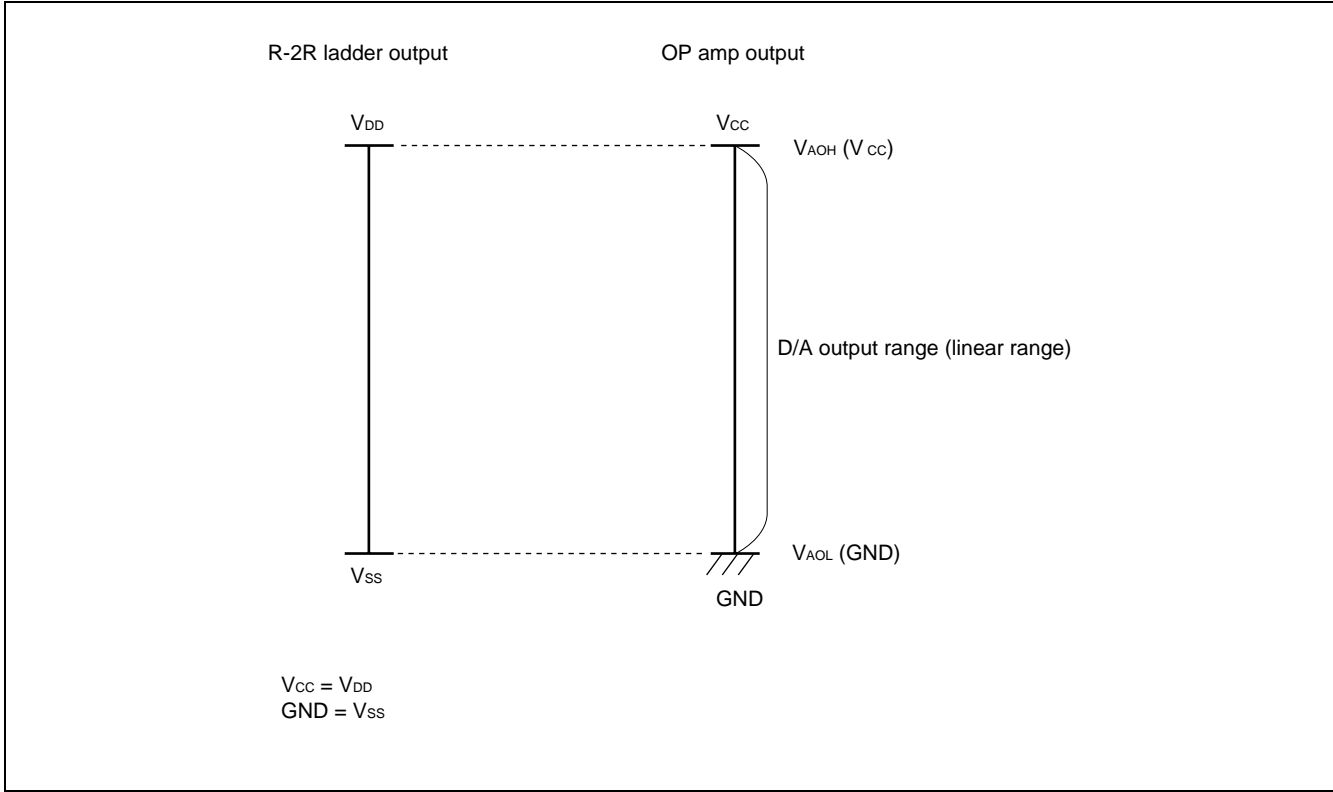

MB88346L

■ ABSOLUTE MAXIMUM RATINGS

Parameter	Symbol	Condition	Rating		Unit
			Min	Max	
Power supply voltage	V _{CC}	GND used as reference, Ta = + 25 °C	- 0.3	+ 7.0	V
	V _{DD} *		- 0.3	+ 7.0	V
Input voltage	V _{IN}		- 0.3	V _{CC} + 0.3	V
Output voltage	V _{OUT}		- 0.3	V _{CC} + 0.3	V
Power consumption	P _D	—	—	250	mW
Operating temperature	Ta	—	- 20	+ 85	°C
Storage temperature	Tstg	—	- 55	+ 150	°C

* : V_{CC} ≥ V_{DD}

WARNING: Semiconductor devices can be permanently damaged by application of stress (voltage, current, temperature, etc.) in excess of absolute maximum ratings. Do not exceed these ratings.

■ RECOMMENDED OPERATING CONDITIONS

Parameter	Symbol	Condition	Value			Unit
			Min	Typ	Max	
Power supply voltage 1	V _{CC}	—	2.7	—	3.6	V
	GND	—	—	0	—	V
Power supply voltage 2	V _{DD}	V _{DD} - V _{SS} ≥ 2.0 V	2.0	—	V _{CC}	V
	V _{SS}		GND	—	V _{CC} - 2.0	V
Analog output source current	I _{AL}	V _{CC} = 3.0 V	—	—	1.0	mA
Analog output sink current	I _{AH}	V _{CC} = 3.0 V	—	—	1.0	mA
Oscillator limiting output capacity	C _{AL}	—	—	—	0.1	μF
Digital data value range	—	—	#00	—	#FF	—
Operating temperature	Ta	—	- 20	—	+ 85	°C

WARNING: The recommended operating conditions are required in order to ensure the normal operation of the semiconductor device. All of the device's electrical characteristics are warranted when the device is operated within these ranges.

Always use semiconductor devices within their recommended operating condition ranges. Operation outside these ranges may adversely affect reliability and could result in device failure.

No warranty is made with respect to uses, operating conditions, or combinations not represented on the data sheet. Users considering application outside the listed conditions are advised to contact their representatives beforehand.

■ ELECTRICAL CHARACTERISTICS

1. DC Characteristics

(1) Digital Block

($V_{DD}, V_{CC} = 2.7\text{ V to }3.6\text{ V}$ ($V_{CC} \geq V_{DD}$), $GND = V_{SS} = 0\text{ V}$, $T_a = -20\text{ }^\circ\text{C to }+85\text{ }^\circ\text{C}$)

Parameter	Symbol	Pin	Condition	Value			Unit
				Min	Typ	Max	
Power supply voltage	V_{CC}	V_{CC}	—	2.7	3.0	3.6	V
Power supply current 1	I_{CC}		Stationary (CLK signal stopped), no load	—	1.2	3.0	mA
Input leak current	I_{ILK}	CLK, DI, LD	$V_{IN} = 0\text{ to }V_{CC}$	-10	—	+10	μA
L level input voltage	V_{IL}		—	—	—	$0.2 V_{CC}$	V
H level input voltage	V_{IH}		—	$0.8 V_{CC}$	—	—	V
L level output voltage	V_{OL}	DO	$I_{OL} = 2.5\text{ mA}$	—	—	0.4	V
H level output voltage	V_{OH}		$I_{OH} = -400\text{ }\mu\text{A}$	$V_{CC} - 0.4$	—	—	V

(2) Analog Block 1

($V_{DD}, V_{CC} = 2.7\text{ V to }3.6\text{ V}$ ($V_{CC} \geq V_{DD}$), $GND = V_S = 0\text{ V}$, $T_a = -20\text{ }^\circ\text{C to }+85\text{ }^\circ\text{C}$)

Parameter	Symbol	Pin	Condition	Value			Unit
				Min	Typ	Max	
Power consumption	I_{DD}	V_{DD}	Maximum setting value from #00 to #FF	—	0.6	1.5	mA
Analog voltage	V_{DD}	V_{DD}	$V_{DD} - V_{SS} \geq 2.0$	2.0	—	V_{CC}	V
	V_{SS}	V_{SS}		GND	—	$V_{CC} - 2.0$	V
Resolution	Res	AO ₁ to AO ₁₂	—	—	8	—	bit
Monotonic increase	Rem		—	—	8	—	bit
Nonlinearity error	LE		$V_{DD} \leq V_{CC} - 0.1\text{ V}$, $V_{SS} \geq 0.1\text{ V}$, no load	-1.5	—	+1.5	LSB
Differential linearity error	DLE		-1.0	—	+1.0	LSB	

Nonlinearity error : Deviation (error) in input/output curves with respect to an ideal straight line connecting output voltage at "00" and output voltage at "FF."

Differential linearity error : Deviation (error) in amplification with respect to theoretical increase in amplification per 1-bit increase in digital value.

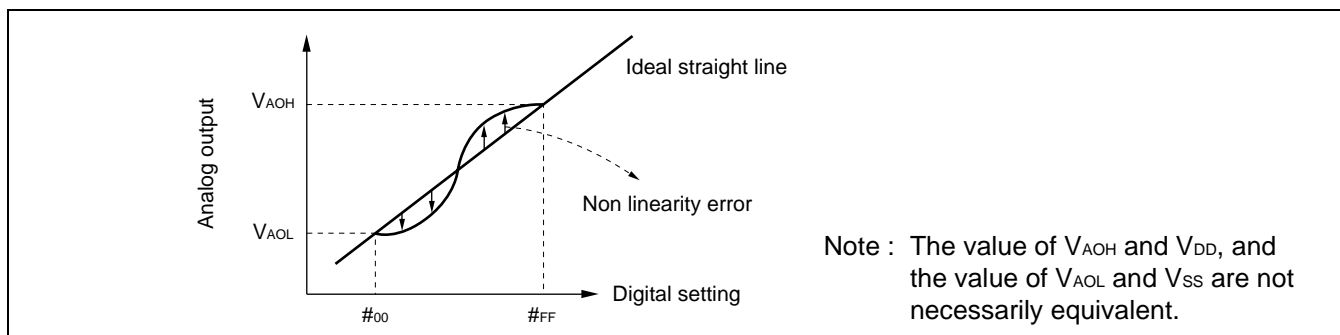

MB88346L

(3) Analog Block 2

($V_{DD}, V_{CC} = 2.7\text{ V to }3.6\text{ V}$ ($V_{CC} \geq V_{DD}$), $GND = V_{SS} = 0\text{ V}$, $T_a = -20\text{ }^\circ\text{C to }+85\text{ }^\circ\text{C}$)

Parameter	Symbol	Pin	Condition	Value			Unit
				Min	Typ	Max	
Output minimum voltage 1	V_{AOL1}	AO ₁ to AO ₁₂	$V_{DD} = V_{CC} = 3.0\text{ V}$, $V_{SS} = GND = 0.0\text{ V}$, $I_{AL} = 0\text{ }\mu\text{A}$ Digital data = #00	V_{SS}	—	$V_{SS} + 0.1$	V
Output minimum voltage 2	V_{AOL2}		$V_{DD} = V_{CC} = 3.0\text{ V}$, $V_{SS} = GND = 0.0\text{ V}$, $I_{AL} = 500\text{ }\mu\text{A}$ Digital data = #00	$V_{SS} - 0.2$	V_{SS}	$V_{SS} + 0.2$	V
Output minimum voltage 3	V_{AOL3}		$V_{DD} = V_{CC} = 3.0\text{ V}$, $V_{SS} = GND = 0.0\text{ V}$, $I_{AH} = 500\text{ }\mu\text{A}$ Digital data = #00	V_{SS}	—	$V_{SS} + 0.2$	V
Output minimum voltage 4	V_{AOL4}		$V_{DD} = V_{CC} = 3.0\text{ V}$, $V_{SS} = GND = 0.0\text{ V}$, $I_{AL} = 1.0\text{ mA}$ Digital data = #00	$V_{SS} - 0.3$	V_{SS}	$V_{SS} + 0.3$	V
Output minimum voltage 5	V_{AOL5}		$V_{DD} = V_{CC} = 3.0\text{ V}$, $V_{SS} = GND = 0.0\text{ V}$, $I_{AH} = 1.0\text{ mA}$ Digital data = #00	V_{SS}	—	$V_{SS} + 0.3$	V
Output maximum voltage 1	V_{AOH1}		$V_{DD} = V_{CC} = 3.0\text{ V}$, $V_{SS} = GND = 0.0\text{ V}$, $I_{AL} = 0\text{ }\mu\text{A}$ Digital data = #FF	$V_{DD} - 0.1$	—	V_{DD}	V
Output maximum voltage 2	V_{AOH2}		$V_{DD} = V_{CC} = 3.0\text{ V}$, $V_{SS} = GND = 0.0\text{ V}$, $I_{AL} = 500\text{ }\mu\text{A}$ Digital data = #FF	$V_{DD} - 0.2$	—	V_{DD}	V
Output maximum voltage 3	V_{AOH3}		$V_{DD} = V_{CC} = 3.0\text{ V}$, $V_{SS} = GND = 0.0\text{ V}$, $I_{AH} = 500\text{ }\mu\text{A}$ Digital data = #FF	$V_{DD} - 0.2$	V_{DD}	$V_{DD} + 0.2$	V
Output maximum voltage 4	V_{AOH4}		$V_{DD} = V_{CC} = 3.0\text{ V}$, $V_{SS} = GND = 0.0\text{ V}$, $I_{AL} = 1.0\text{ mA}$ Digital data = #FF	$V_{DD} - 0.3$	—	V_{DD}	V
Output maximum voltage 5	V_{AOH5}		$V_{DD} = V_{CC} = 3.0\text{ V}$, $V_{SS} = GND = 0.0\text{ V}$, $I_{AH} = 1.0\text{ mA}$ Digital data = #FF	$V_{DD} - 0.3$	V_{DD}	$V_{DD} + 0.3$	V

2. AC Characteristics

($V_{DD}, V_{CC} = 2.7\text{ V to }3.6\text{ V}$ ($V_{CC} \geq V_{DD}$), $GND = V_{SS} = 0\text{ V}$, $T_a = -20\text{ }^\circ\text{C to }+85\text{ }^\circ\text{C}$)

Parameter	Symbol	Condition	Value		Unit
			Min	Max	
Clock L level pulse width	t_{CKL}	—	200	—	ns
Clock H level pulse width	t_{CKH}	—	200	—	ns
Clock rise time Clock fall time	t_{Cr} t_{Cf}	—	—	200	ns
Data setup time	t_{DCH}	—	30	—	ns
Data hold time	t_{CHD}	—	60	—	ns
Load setup time	t_{CHL}	—	200	—	ns
Load hold time	t_{LDC}	—	100	—	ns
Load H level pulse width	t_{LDH}	—	100	—	ns
Data output delay time	t_{DO}	Refer to “• Load condition 1”	70	600	ns
D/A output settling time	t_{LDD}	Refer to “• Load condition 2”	—	300	μs

• Load condition 1

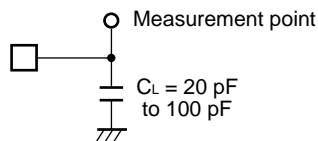

• Load condition 2

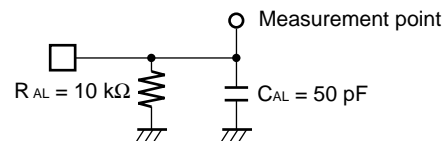

MB88346L

• Input/output timing

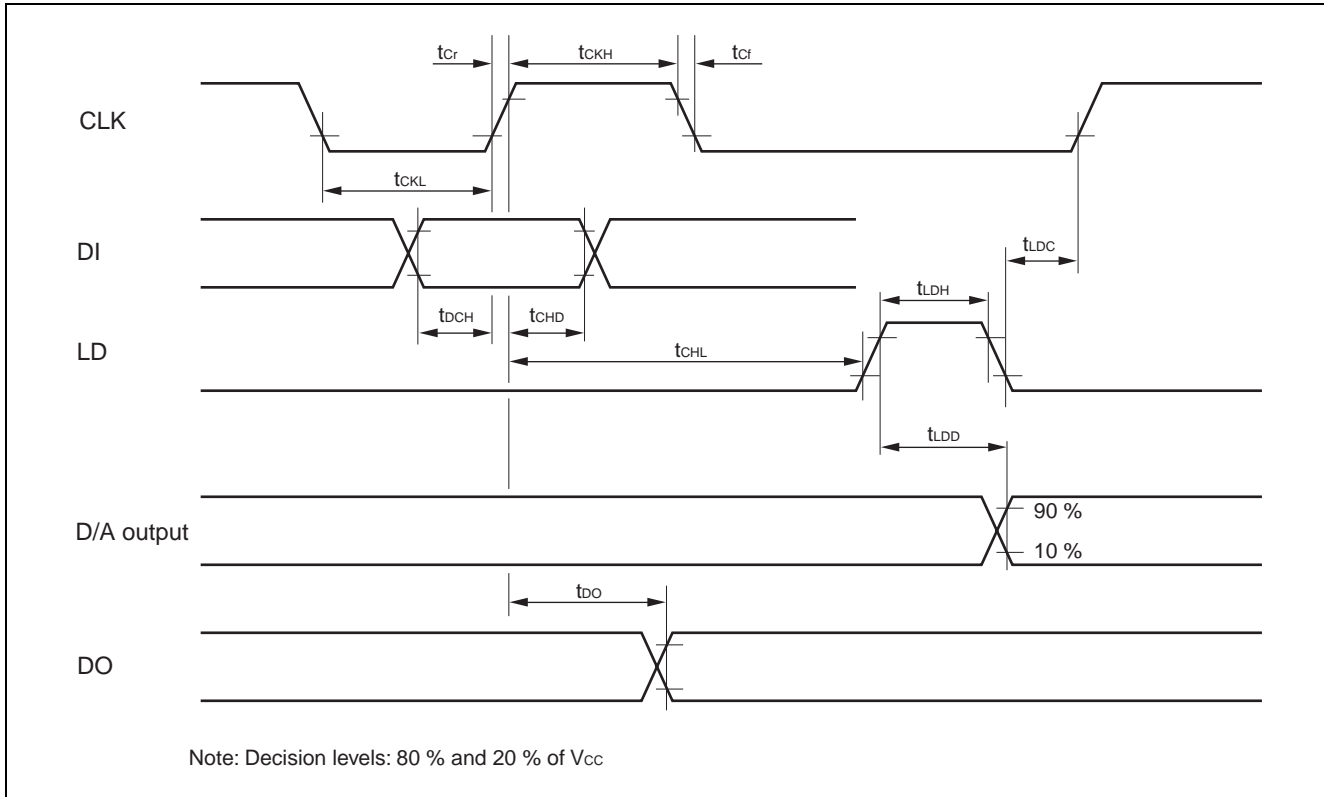

■ V_{AO} vs. I_{AO} CHARACTERISTICS : EXAMPLE

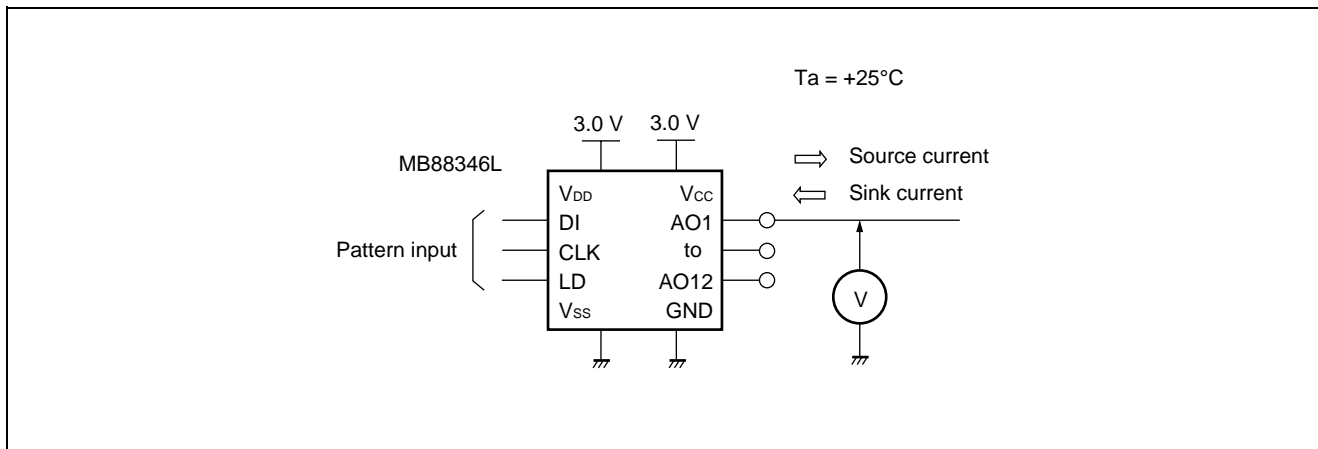

(Continued)

(Continued)

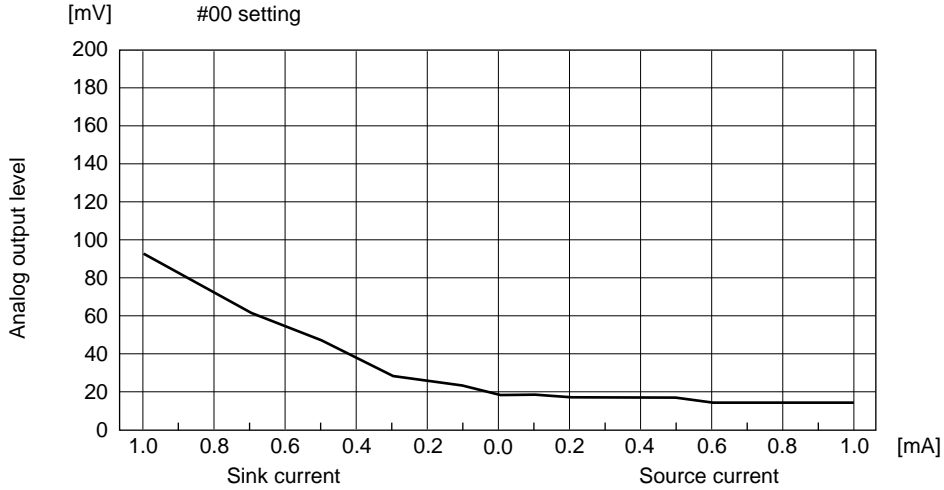
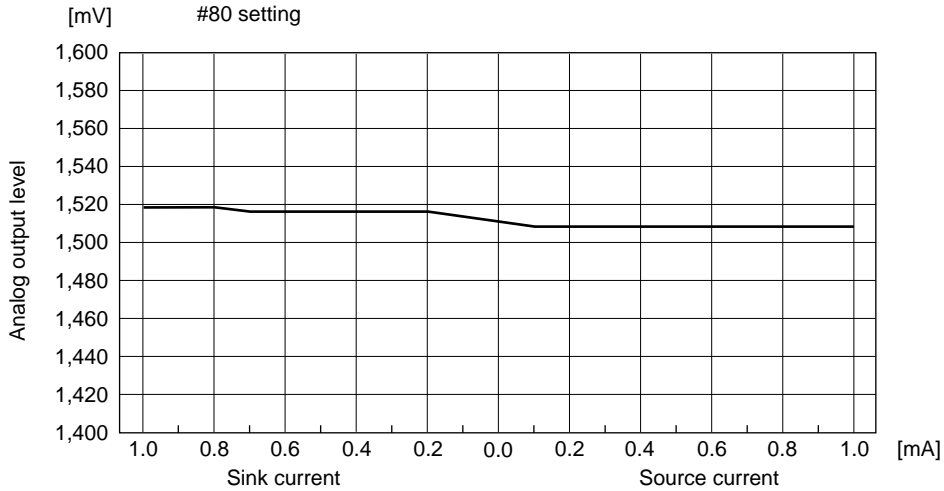
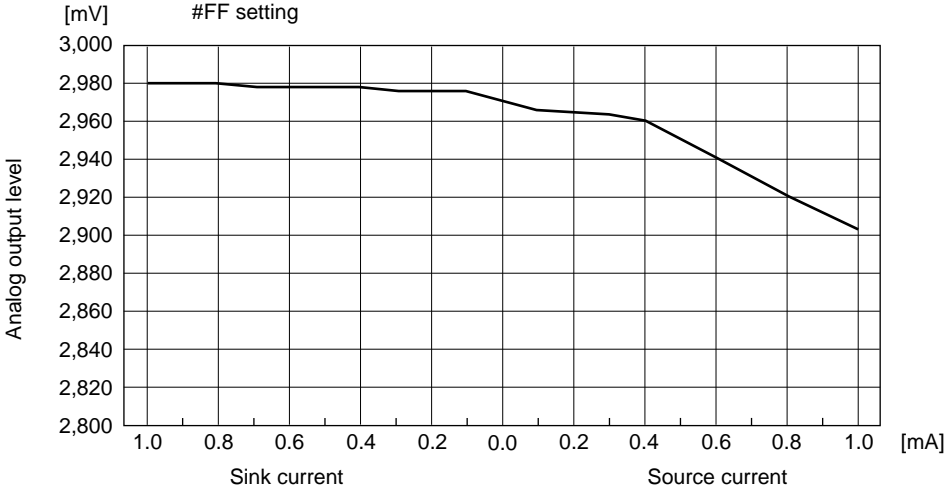

MB88346L

■ ORDERING INFORMATION

Part number	Package	Remarks
MB88346LP	20-pin plastic DIP (DIP-20P-M02)	
MB88346LPFV	20-pin plastic SSOP (FPT-20P-M03)	

■ PACKAGE DIMENSIONS

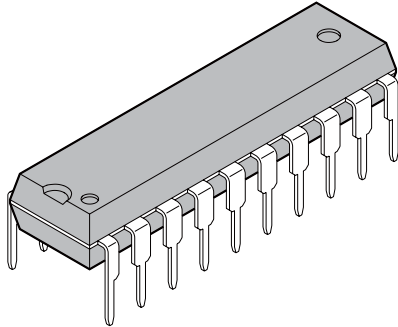
<p style="text-align: center;">20-pin plastic DIP</p>  <p style="text-align: center;">(DIP-20P-M02)</p>	Lead pitch	2.54mm(100mil)
	Row spacing	7.62mm(300mil)
	Sealing method	Plastic mold

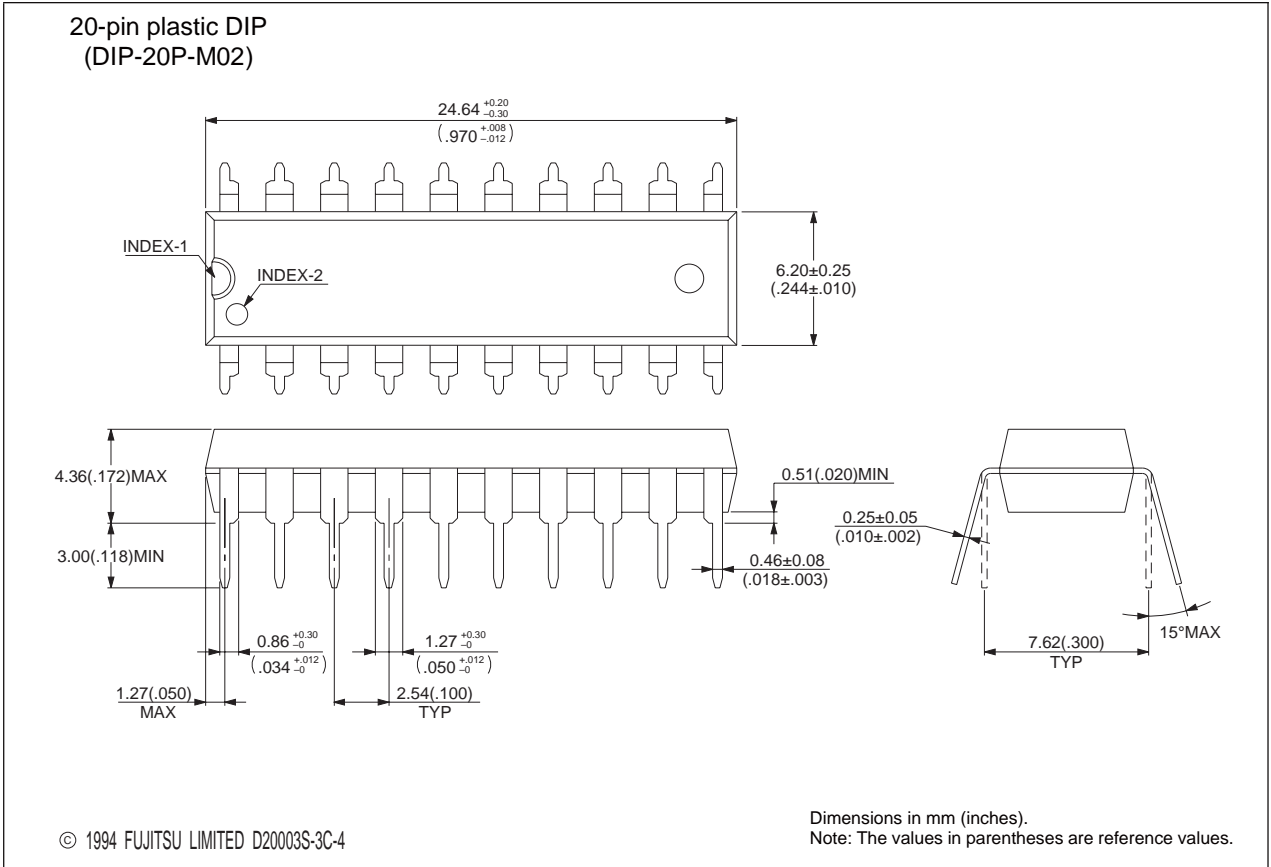

Please confirm the latest Package dimension by following URL.
<http://edevic.fujitsu.com/package/en-search/>

(Continued)

MB88346L

(Continued)

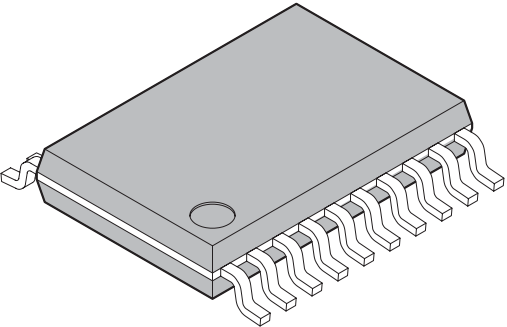
<p>20-pin plastic SSOP</p>  <p>(FPT-20P-M03)</p>	Lead pitch	0.65 mm
	Package width × package length	4.40 × 6.50 mm
	Lead shape	Gullwing
	Sealing method	Plastic mold
	Mounting height	1.45 mmMAX
	Weight	0.09g
	Code (Reference)	P-SSOP20-4.4×6.5-0.65

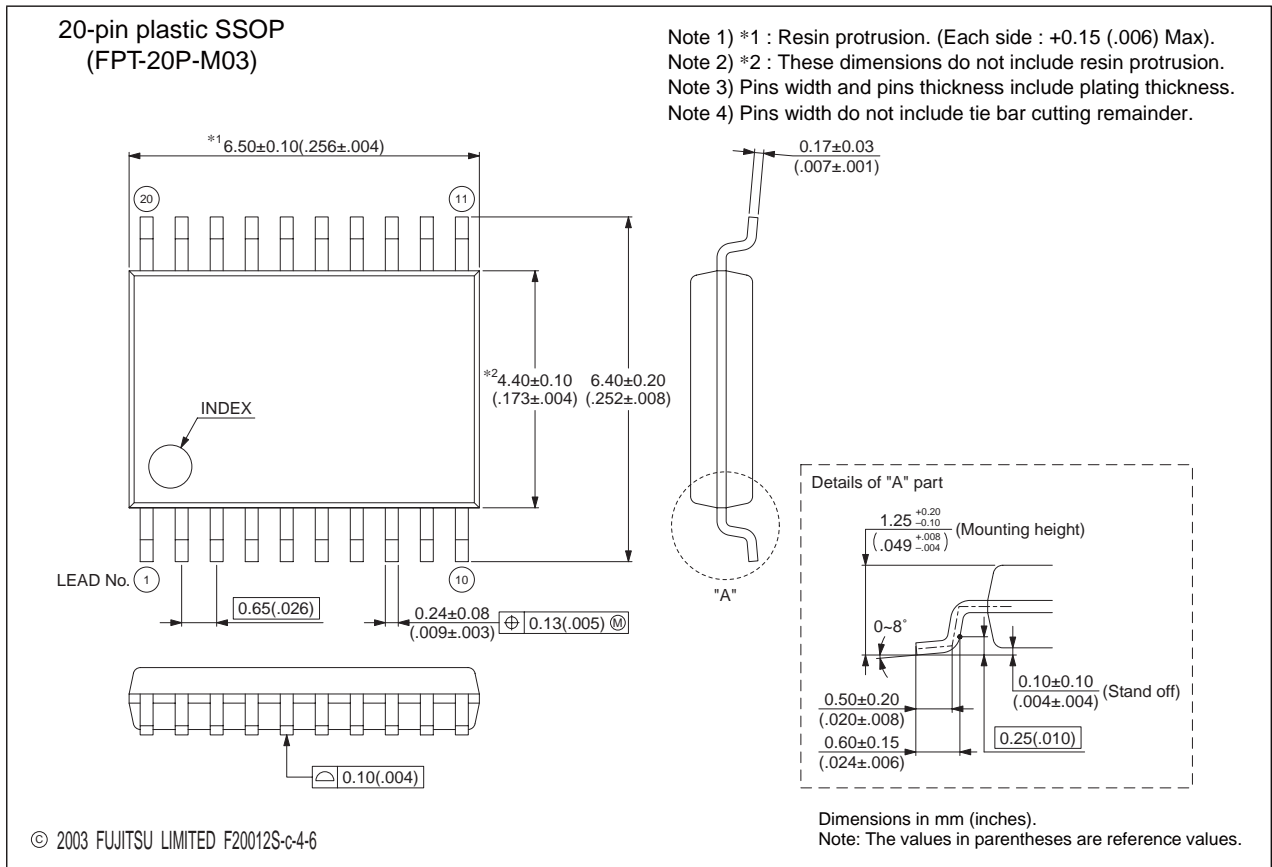

Please confirm the latest Package dimension by following URL.
<http://edevic.fujitsu.com/package/en-search/>

MEMO

MEMO



MEMO

FUJITSU MICROELECTRONICS LIMITED

Shinjuku Dai-Ichi Seimei Bldg. 7-1, Nishishinjuku 2-chome, Shinjuku-ku,
Tokyo 163-0722, Japan Tel: +81-3-5322-3347 Fax: +81-3-5322-3387
<http://jp.fujitsu.com/fml/en/>

For further information please contact:

North and South America

FUJITSU MICROELECTRONICS AMERICA, INC.
1250 E. Arques Avenue, M/S 333
Sunnyvale, CA 94085-5401, U.S.A.
Tel: +1-408-737-5600 Fax: +1-408-737-5999
<http://www.fma.fujitsu.com/>

Europe

FUJITSU MICROELECTRONICS EUROPE GmbH
Pittlerstrasse 47, 63225 Langen,
Germany
Tel: +49-6103-690-0 Fax: +49-6103-690-122
<http://emea.fujitsu.com/microelectronics/>

Korea

FUJITSU MICROELECTRONICS KOREA LTD.
206 KOSMO TOWER, 1002 Daechi-Dong,
Kangnam-Gu, Seoul 135-280
Korea
Tel: +82-2-3484-7100 Fax: +82-2-3484-7111
<http://www.fmk.fujitsu.com/>

Asia Pacific

FUJITSU MICROELECTRONICS ASIA PTE LTD.
151 Lorong Chuan, #05-08 New Tech Park,
Singapore 556741
Tel: +65-6281-0770 Fax: +65-6281-0220
<http://www.fujitsu.com/sg/services/micro/semiconductor/>

FUJITSU MICROELECTRONICS SHANGHAI CO., LTD.
Rm.3102, Bund Center, No.222 Yan An Road(E),
Shanghai 200002, China
Tel: +86-21-6335-1560 Fax: +86-21-6335-1605
<http://cn.fujitsu.com/fmc/>

FUJITSU MICROELECTRONICS PACIFIC ASIA LTD.
10/F., World Commerce Centre, 11 Canton Road
Tsimshatsui, Kowloon
Hong Kong
Tel: +852-2377-0226 Fax: +852-2376-3269
<http://cn.fujitsu.com/fmc/tw>

All Rights Reserved.

The contents of this document are subject to change without notice.

Customers are advised to consult with sales representatives before ordering.

The information, such as descriptions of function and application circuit examples, in this document are presented solely for the purpose of reference to show examples of operations and uses of FUJITSU MICROELECTRONICS device; FUJITSU MICROELECTRONICS does not warrant proper operation of the device with respect to use based on such information. When you develop equipment incorporating the device based on such information, you must assume any responsibility arising out of such use of the information.

FUJITSU MICROELECTRONICS assumes no liability for any damages whatsoever arising out of the use of the information.

Any information in this document, including descriptions of function and schematic diagrams, shall not be construed as license of the use or exercise of any intellectual property right, such as patent right or copyright, or any other right of FUJITSU MICROELECTRONICS or any third party or does FUJITSU MICROELECTRONICS warrant non-infringement of any third-party's intellectual property right or other right by using such information. FUJITSU MICROELECTRONICS assumes no liability for any infringement of the intellectual property rights or other rights of third parties which would result from the use of information contained herein.

The products described in this document are designed, developed and manufactured as contemplated for general use, including without limitation, ordinary industrial use, general office use, personal use, and household use, but are not designed, developed and manufactured as contemplated (1) for use accompanying fatal risks or dangers that, unless extremely high safety is secured, could have a serious effect to the public, and could lead directly to death, personal injury, severe physical damage or other loss (i.e., nuclear reaction control in nuclear facility, aircraft flight control, air traffic control, mass transport control, medical life support system, missile launch control in weapon system), or (2) for use requiring extremely high reliability (i.e., submersible repeater and artificial satellite).

Please note that FUJITSU MICROELECTRONICS will not be liable against you and/or any third party for any claims or damages arising in connection with above-mentioned uses of the products.

Any semiconductor devices have an inherent chance of failure. You must protect against injury, damage or loss from such failures by incorporating safety design measures into your facility and equipment such as redundancy, fire protection, and prevention of over-current levels and other abnormal operating conditions.

Exportation/release of any products described in this document may require necessary procedures in accordance with the regulations of the Foreign Exchange and Foreign Trade Control Law of Japan and/or US export control laws.

The company names and brand names herein are the trademarks or registered trademarks of their respective owners.