



February 2000
Revised February 2000

74LCXZ16240

Low Voltage 16-Bit Inverting Buffer/Line Driver with 5V Tolerant Inputs/Outputs (Preliminary)

General Description

The LCXZ16240 contains sixteen inverting buffers with 3-STATE outputs designed to be employed as a memory and address driver, clock driver, or bus-oriented transmitter/receiver. The device is nibble controlled. Each nibble has separate 3-STATE control inputs which can be shorted together for full 16-bit operation.

When V_{CC} is between 0 and 1.5V, the LCXZ16240 is in the high impedance state during power up or power down. This places the outputs in the high impedance (Z) state preventing intermittent low impedance loading or glitching in bus oriented applications.

The LCXZ16240 is designed for low voltage (2.7V or 3.3V) V_{CC} applications with capacity of interfacing to a 5V signal environment.

The LCXZ16240 is fabricated with an advanced CMOS technology to achieve high speed operation while maintaining CMOS low power dissipation.

Features

- 5V tolerant inputs and outputs
- Guaranteed power up/down high impedance
- Supports live insertion/withdrawal
- 2.7V–3.6V V_{CC} specifications provided
- 4.5 ns t_{PD} max ($V_{CC} = 3.3V$), 20 μA I_{CC} max
- ± 24 mA output drive ($V_{CC} = 3.0V$)
- Implements patented noise/EMI reduction circuitry
- Latch-up performance exceeds 500 mA
- ESD performance:
 - Human body model > 2000V
 - Machine model > 200V

Ordering Code:

Order Number	Package Number	Package Description
74LCXZ16240MEA	MS48A	48-Lead Small Shrink Outline Package (SSOP), JEDEC MO-118, 0.300" Wide
74LCXZ16240MTD	MTD48	48-Lead Thin Shrink Small Outline Package (TSSOP), JEDEC MO-153, 6.1mm Wide

Devices also available in Tape and Reel. Specify by appending the suffix letter "X" to the ordering code.

Connection Diagram

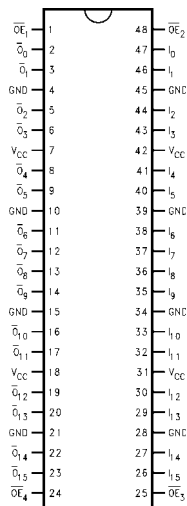

Logic Symbol

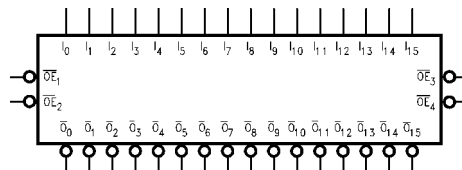

Pin Descriptions

Pin Names	Description
\overline{OE}_n	Output Enable Inputs (Active LOW)
I_0 – I_{15}	Inputs
\overline{O}_0 – \overline{O}_{15}	Outputs

74LCXZ16240 Low Voltage 16-Bit Inverting Buffer/Line Driver with 5V Tolerant Inputs/Outputs (Preliminary)

Truth Tables

Inputs		Outputs
\overline{OE}_1	I ₀ -I ₃	\overline{O}_0 - \overline{O}_3
L	L	H
L	H	L
H	X	Z

Inputs		Outputs
\overline{OE}_3	I ₈ -I ₁₁	\overline{O}_8 - \overline{O}_{11}
L	L	H
L	H	L
H	X	Z

Inputs		Outputs
\overline{OE}_2	I ₄ -I ₇	\overline{O}_4 - \overline{O}_7
L	L	H
L	H	L
H	X	Z

Inputs		Outputs
\overline{OE}_4	I ₁₂ -I ₁₅	\overline{O}_{12} - \overline{O}_{15}
L	L	H
L	H	L
H	X	Z

H = HIGH Voltage Level
 L = LOW Voltage Level
 X = Immaterial
 Z = High Impedance

Functional Description

The LCXZ16240 contains sixteen inverting buffers with 3-STATE standard outputs. The device is nibble (4 bits) controlled with each nibble functioning identically, but independent of the other. The control pins may be shorted together to obtain full 16-bit operation. The 3-STATE outputs are

controlled by an Output Enable (\overline{OE}_n) input for each nibble. When \overline{OE}_n is LOW, the outputs are in 2-state mode. When \overline{OE}_n is HIGH, the outputs are in the high impedance mode, but this does not interfere with entering new data into the inputs.

Logic Diagram

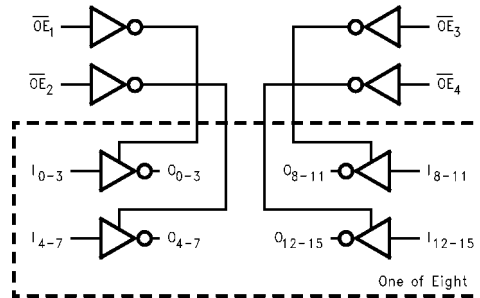

Absolute Maximum Ratings ^(Note 1)					
Symbol	Parameter	Value	Conditions	Units	
V _{CC}	Supply Voltage	-0.5 to +7.0		V	
V _I	DC Input Voltage	-0.5 to +7.0		V	
V _O	DC Output Voltage	-0.5 to +7.0 -0.5 to V _{CC} + 0.5	Output in 3-STATE or V _{CC} = 0-1.5V Output in HIGH or LOW State (Note 2)	V	
I _{IK}	DC Input Diode Current	-50	V _I < GND	mA	
I _{OK}	DC Output Diode Current	-50 +50	V _O < GND V _O > V _{CC}	mA	
I _O	DC Output Source/Sink Current	±50		mA	
I _{CC}	DC Supply Current per Supply Pin	±100		mA	
I _{GND}	DC Ground Current per Ground Pin	±100		mA	
T _{STG}	Storage Temperature	-65 to +150		°C	

Recommended Operating Conditions (Note 3)						
Symbol	Parameter	Min	Max	Units		
V _{CC}	Supply Voltage	Operating		2.7	3.6	V
V _I	Input Voltage	0	5.5	V		
V _O	Output Voltage	HIGH or LOW State		0	V _{CC}	V
		3-STATE or V _{CC} = OFF		0	5.5	V
I _{OH} /I _{OL}	Output Current	V _{CC} = 3.0V - 3.6V V _{CC} = 2.7V - 3.0V			±24 ±12	mA
T _A	Free-Air Operating Temperature	-40	85	°C		
Δt/ΔV	Input Edge Rate, V _{IN} = 0.8V-2.0V, V _{CC} = 3.0V	0	10	ns/V		

Note 1: The Absolute Maximum Ratings are those values beyond which the safety of the device cannot be guaranteed. The device should not be operated at these limits. The parametric values defined in the Electrical Characteristics tables are not guaranteed at the Absolute Maximum Ratings. The "Recommended Operating Conditions" table will define the conditions for actual device operation.

Note 2: I_O Absolute Maximum Rating must be observed.

Note 3: Unused inputs must be held HIGH or LOW. They may not float.

DC Electrical Characteristics

Symbol	Parameter	Conditions	V _{CC} (V)	T _A = -40°C to +85°C		Units
				Min	Max	
V _{IH}	HIGH Level Input Voltage		2.7 - 3.6	2.0		V
V _{IL}	LOW Level Input Voltage		2.7 - 3.6		0.8	V
V _{OH}	HIGH Level Output Voltage	I _{OH} = -100 μA	2.7 - 3.6	V _{CC} - 0.2		V
		I _{OH} = -12 mA	2.7	2.2		
		I _{OH} = -18 mA	3.0	2.4		
		I _{OH} = -24 mA	3.0	2.2		
V _{OL}	LOW Level Output Voltage	I _{OL} = 100 μA	2.7 - 3.6		0.2	V
		I _{OL} = 12 mA	2.7		0.4	
		I _{OL} = 16 mA	3.0		0.4	
		I _{OL} = 24 mA	3.0		0.55	
I _I	Input Leakage Current	0 ≤ V _I ≤ 5.5V	2.7 - 3.6		±5.0	μA
I _{OZ}	3-STATE Output Leakage	0 ≤ V _O ≤ 5.5V V _I = V _{IH} or V _{IL}	2.7 - 3.6		±5.0	μA
I _{OFF}	Power-Off Leakage Current	V _I or V _O = 5.5V	0		10	μA
I _{PU/PD}	Power Up/Down 3-STATE Output Current	V _O = 0.5V to V _{CC} V _I = GND or V _{CC}	0 - 1.5		±5.0	μA
I _{CC}	Quiescent Supply Current	V _I = V _{CC} or GND	2.7 - 3.6		225	μA
		3.6V ≤ V _I , V _O ≤ 5.5V (Note 4)	2.7 - 3.6		±225	
ΔI _{CC}	Increase in I _{CC} per Input	V _{IH} = V _{CC} - 0.6V	2.7 - 3.6		500	μA

Note 4: Outputs disabled or 3-STATE only.

AC Electrical Characteristics						
Symbol	Parameter	$T_A = -40^\circ\text{C to } +85^\circ\text{C}, R_L = 500\ \Omega$				Units
		$V_{CC} = 3.3\text{V} \pm 0.3\text{V}$		$V_{CC} = 2.7\text{V}$		
		$C_L = 50\ \text{pF}$		$C_L = 50\ \text{pF}$		
		Min	Max	Min	Max	
t_{PHL}	Propagation Delay	1.5	4.5	1.5	5.3	ns
t_{PLH}	Data to Output	1.5	4.5	1.5	5.3	
t_{PZL}	Output Enable Time	1.5	5.4	1.5	6.0	ns
t_{PZH}		1.5	5.4	1.5	6.0	
t_{PLZ}	Output Disable Time	1.5	5.3	1.5	5.4	ns
t_{PHZ}		1.5	5.3	1.5	5.4	
t_{OSHL}	Output to Output Skew (Note 5)		1.0			ns
t_{OSLH}			1.0			

Note 5: Skew is defined as the absolute value of the difference between the actual propagation delay for any two separate outputs of the same device. The specification applies to any outputs switching in the same direction, either HIGH-to-LOW (t_{OSHL}) or LOW-to-HIGH (t_{OSLH}).

Dynamic Switching Characteristics					
Symbol	Parameter	Conditions	V_{CC} (V)	$T_A = 25^\circ\text{C}$	Unit
				Typical	
V_{OLP}	Quiet Output Dynamic Peak V_{OL}	$C_L = 50\ \text{pF}, V_{IH} = 3.3\text{V}, V_{IL} = 0\text{V}$	3.3	0.8	V
V_{OLV}	Quiet Output Dynamic Valley V_{OL}	$C_L = 50\ \text{pF}, V_{IH} = 3.3\text{V}, V_{IL} = 0\text{V}$	3.3	-0.8	V

Capacitance				
Symbol	Parameter	Conditions	Typical	Units
C_{IN}	Input Capacitance	$V_{CC} = \text{Open}, V_I = 0\text{V or } V_{CC}$	7	pF
C_{OUT}	Output Capacitance	$V_{CC} = 3.3\text{V}, V_I = 0\text{V or } V_{CC}$	8	pF
C_{PD}	Power Dissipation Capacitance	$V_{CC} = 3.3\text{V}, V_I = 0\text{V or } V_{CC}, f = 10\ \text{MHz}$	20	pF

AC LOADING and WAVEFORMS Generic for LCX Family

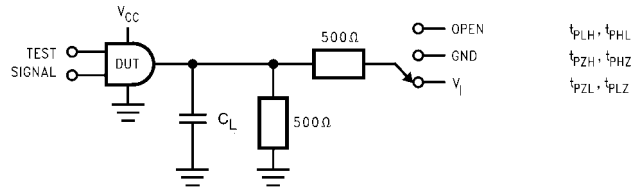
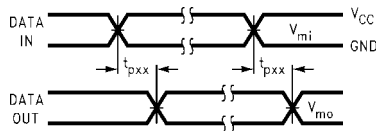
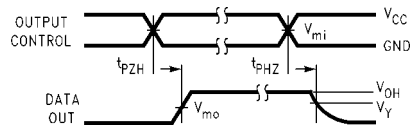

FIGURE 1. AC Test Circuit (C_L includes probe and jig capacitance)

V_I	C_L
6V for $V_{CC} = 3.3V, 2.7V$	50 pF
$V_{CC} * 2$ for $V_{CC} = 2.5V$	30 pF



Waveform for Inverting and Non-Inverting Functions



3-STATE Output High Enable and Disable Times for Logic

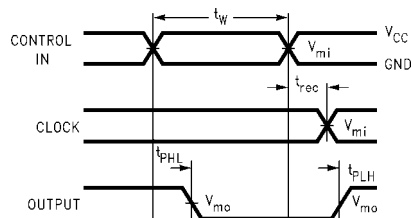

Propagation Delay, Pulse Width and t_{rec} Waveforms

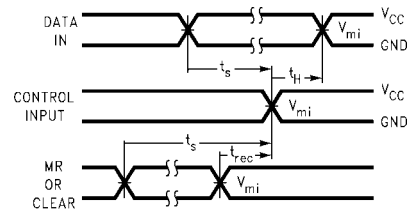

Setup Time, Hold Time and Recovery Time for Logic

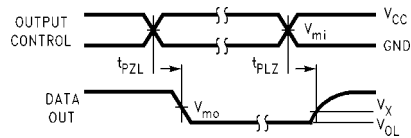

3-STATE Output Low Enable and Disable Times for Logic

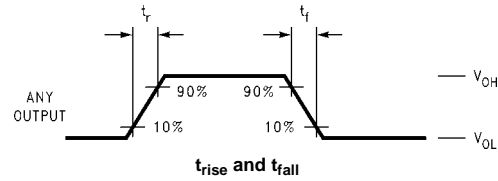
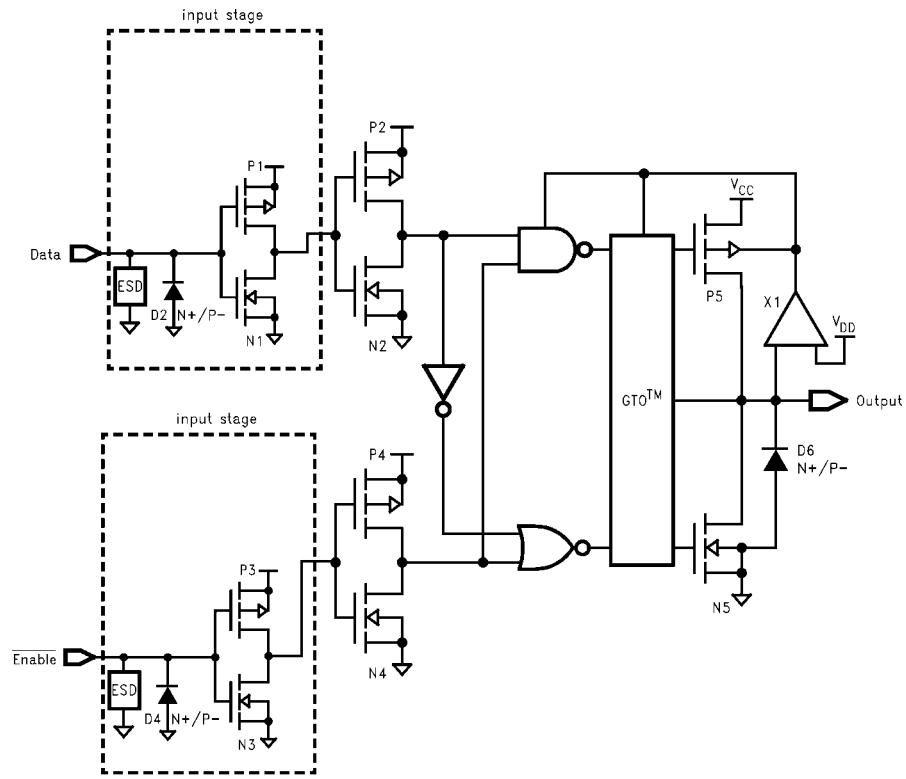

FIGURE 2. Waveforms
(Input Characteristics; $f = 1MHz, t_R = t_F = 3ns$)

Symbol	V_{CC}	
	$3.3V \pm 0.3V$	$2.7V$
V_{mi}	1.5V	1.5V
V_{mo}	1.5V	1.5V
V_x	$V_{OL} + 0.3V$	$V_{OL} + 0.3V$
V_y	$V_{OH} - 0.3V$	$V_{OH} - 0.3V$

74LCXZ16240

Schematic Diagram Generic for LCX Family



Physical Dimensions inches (millimeters) unless otherwise noted (Continued)

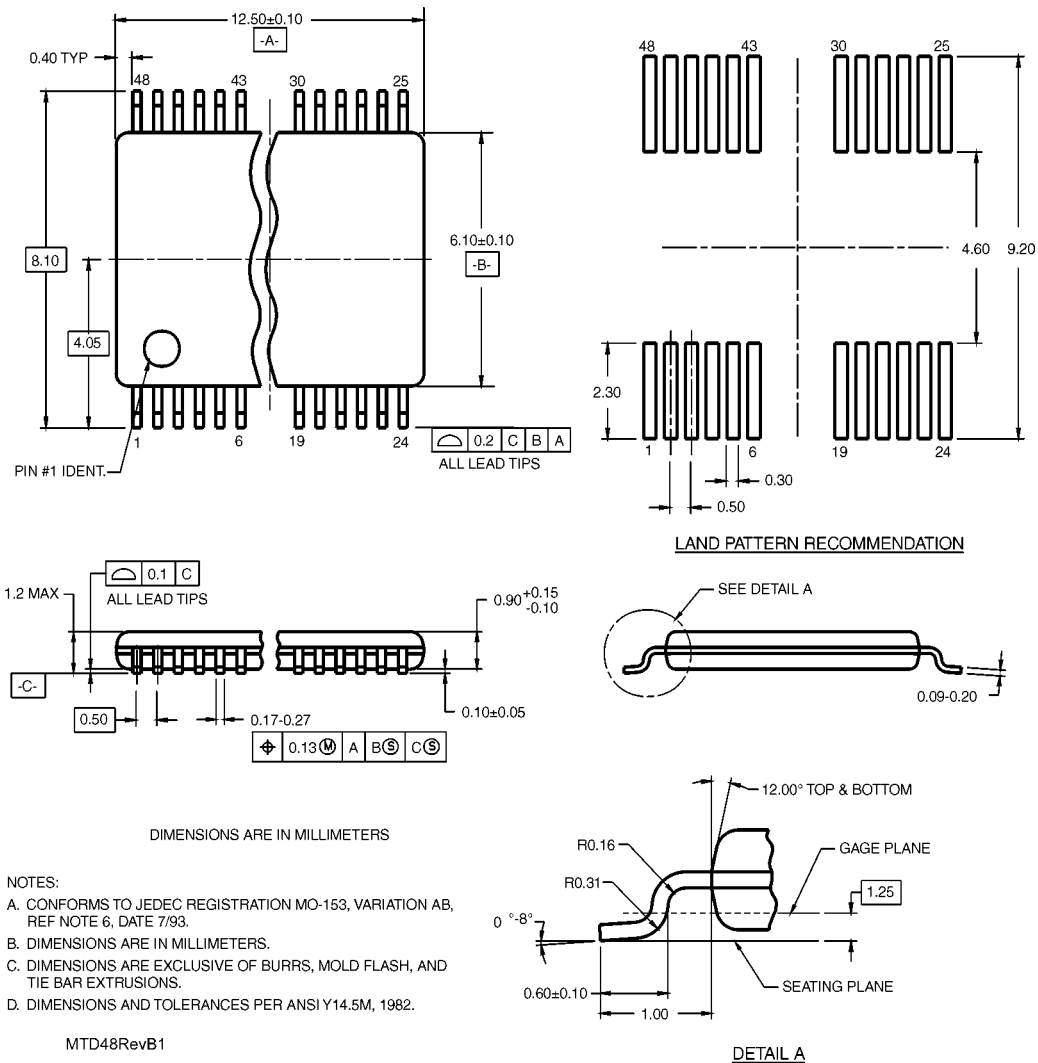

Fairchild does not assume any responsibility for use of any circuitry described, no circuit patent licenses are implied and Fairchild reserves the right at any time without notice to change said circuitry and specifications.

LIFE SUPPORT POLICY

FAIRCHILD'S PRODUCTS ARE NOT AUTHORIZED FOR USE AS CRITICAL COMPONENTS IN LIFE SUPPORT DEVICES OR SYSTEMS WITHOUT THE EXPRESS WRITTEN APPROVAL OF THE PRESIDENT OF FAIRCHILD SEMICONDUCTOR CORPORATION. As used herein:

1. Life support devices or systems are devices or systems which, (a) are intended for surgical implant into the body, or (b) support or sustain life, and (c) whose failure to perform when properly used in accordance with instructions for use provided in the labeling, can be reasonably expected to result in a significant injury to the user.
2. A critical component in any component of a life support device or system whose failure to perform can be reasonably expected to cause the failure of the life support device or system, or to affect its safety or effectiveness.

www.fairchildsemi.com