

8-Mbit (512K x 16) Static RAM

Features

- TSOP I package configurable as 512K x 16 or as 1M x 8 SRAM
- High speed: 45 ns
- Wide voltage range: 2.20V–3.60V
- Pin compatible with CY62157DV30
- Ultra low standby power
 - Typical Standby current: 2 μ A
 - Maximum Standby current: 8 μ A (Industrial)
- Ultra low active power
 - Typical active current: 1.8 mA @ f = 1 MHz
- Easy memory expansion with \overline{CE}_1 , CE_2 , and \overline{OE} features
- Automatic power down when deselected
- CMOS for optimum speed and power
- Available in both Pb-free and non Pb-free 48-ball VFBGA, Pb-free 44-pin TSOP II and 48-pin TSOP I packages

Functional Description^[1]

The CY62157EV30 is a high performance CMOS static RAM organized as 512K words by 16 bits. This device features advanced circuit design to provide ultra low active current. This is ideal for providing More Battery Life™ (MoBL[®]) in portable applications such as cellular telephones. The device also has an automatic power down feature that significantly

reduces power consumption when addresses are not toggling. Place the device into standby mode when deselected (\overline{CE}_1 HIGH or CE_2 LOW or both BHE and BLE are HIGH). The input or output pins (IO_0 through IO_{15}) are placed in a high impedance state when:

- Deselected (\overline{CE}_1 HIGH or CE_2 LOW)
- Outputs are disabled (\overline{OE} HIGH)
- Both Byte High Enable and Byte Low Enable are disabled (\overline{BHE} , BLE HIGH)
- Write operation is active (\overline{CE}_1 LOW, CE_2 HIGH and \overline{WE} LOW)

To write to the device, take Chip Enable (\overline{CE}_1 LOW and CE_2 HIGH) and Write Enable (\overline{WE}) inputs LOW. If Byte Low Enable (BLE) is LOW, then data from IO pins (IO_0 through IO_7) is written into the location specified on the address pins (A_0 through A_{18}). If Byte High Enable (BHE) is LOW, then data from IO pins (IO_8 through IO_{15}) is written into the location specified on the address pins (A_0 through A_{18}).

To read from the device, take Chip Enable (\overline{CE}_1 LOW and CE_2 HIGH) and Output Enable (\overline{OE}) LOW while forcing the Write Enable (\overline{WE}) HIGH. If Byte Low Enable (BLE) is LOW, then data from the memory location specified by the address pins appear on IO_0 to IO_7 . If Byte High Enable (BHE) is LOW, then data from memory appears on IO_8 to IO_{15} . See the "Truth Table" on page 10 for a complete description of read and write modes.

Logic Block Diagram

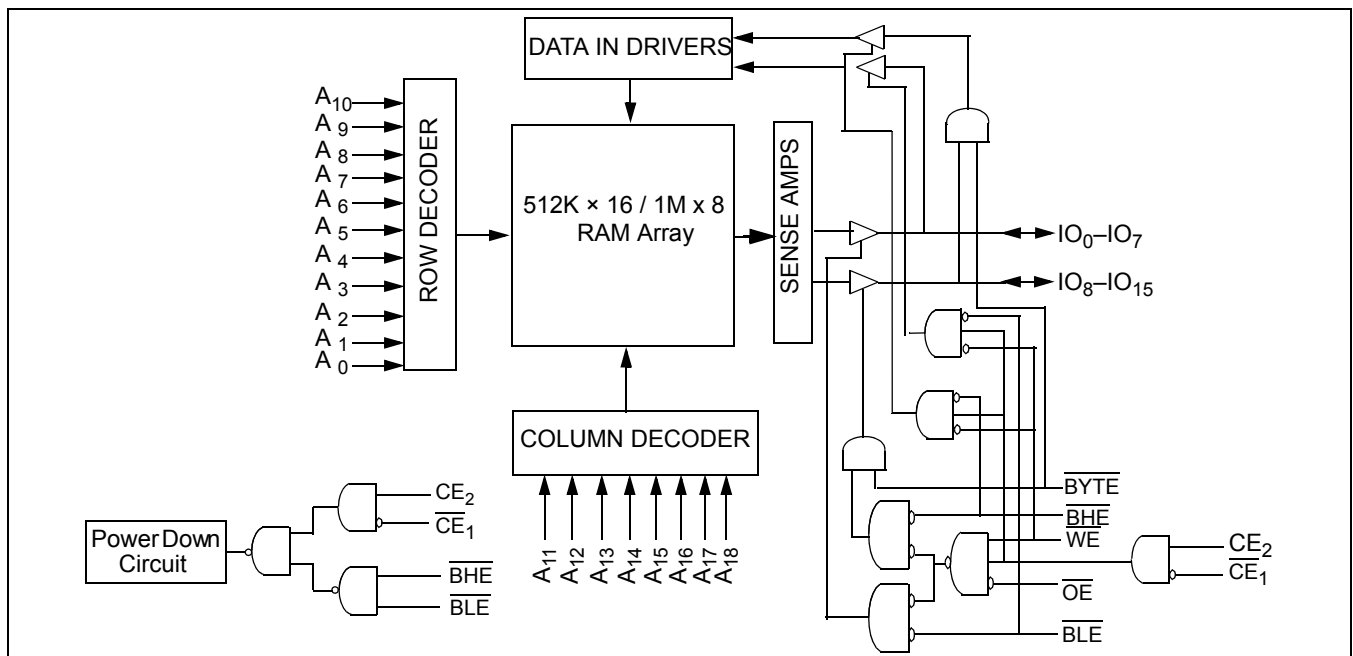

Notes

1. For best practice recommendations, please refer to the Cypress application note [AN1064, SRAM System Guidelines](#).

Product Portfolio

Product	Range	V _{CC} Range (V)			Speed (ns)	Power Dissipation					
						Operating I _{CC} (mA)				Standby, I _{SB2} (μA)	
		f = 1MHz		f = f _{max}							
		Min	Typ [2]	Max		Typ [2]	Max	Typ [2]	Max	Typ [2]	Max
CY62157EV30LL	Ind'l/Auto-A	2.2V	3.0	3.6	45	1.8	3	18	25	2	8

Pin Configuration

The following pictures show the 44-pin TSOP II and 48-pin TSOP I pinouts.^[3, 4, 5]

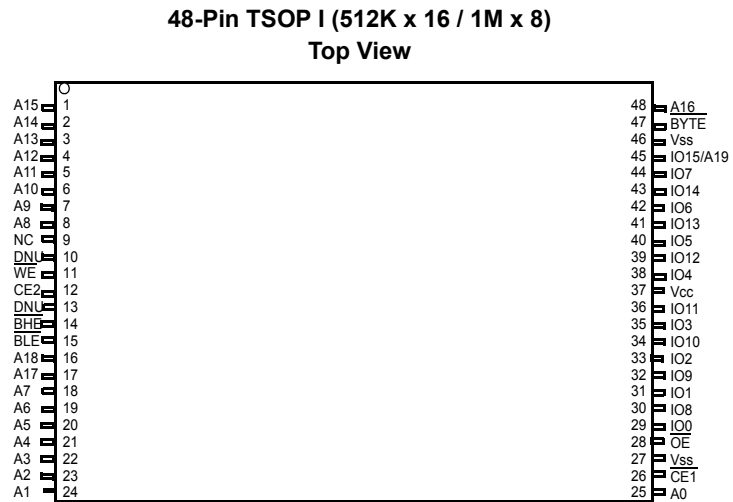
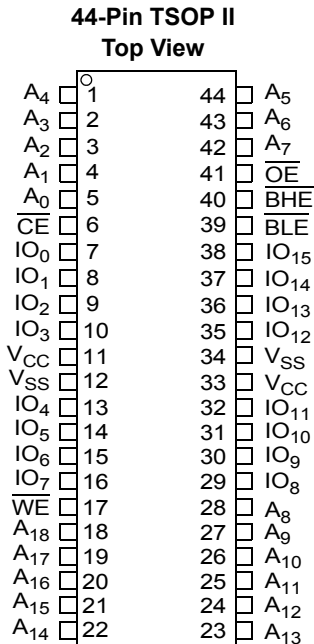

Notes

- Typical values are included for reference only and are not guaranteed or tested. Typical values are measured at V_{CC} = V_{CC(typ)}, T_A = 25°C.
- NC pins are not connected on the die.
- The 44-TSOP II package has only one chip enable (CE) pin.
- The BYTE pin in the 48-TSOP I package has to be tied HIGH to use the device as a 512K x 16 SRAM. The 48-TSOP I package can also be used as a 1M x 8 SRAM by tying the BYTE signal LOW. In the 1M x 8 configuration, Pin 45 is A19, while BHE, BLE and IO8 to IO14 pins are not used (DNU).

Pin Configuration (continued)

The following picture shows the 48-ball VFBGA pinout.^[3, 4, 5]

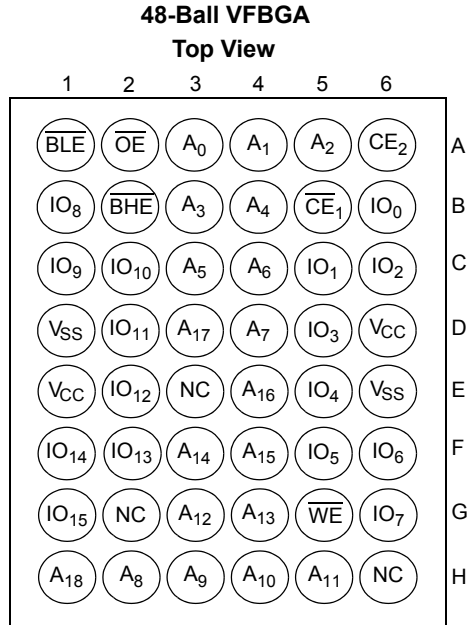

Maximum Ratings

Exceeding maximum ratings may shorten the battery life of the device. User guidelines are not tested.

Storage Temperature -65°C to + 150°C
 Ambient Temperature with Power Applied -55°C to + 125°C
 Supply Voltage to Ground Potential -0.3V to 3.9V ($V_{CCmax} + 0.3V$)
 DC Voltage Applied to Outputs in High-Z State ^[6, 7] -0.3V to 3.9V ($V_{CCmax} + 0.3V$)

DC Input Voltage ^[6, 7] -0.3V to 3.9V ($V_{CCmax} + 0.3V$)
 Output Current into Outputs (LOW) 20 mA
 Static Discharge Voltage > 2001V (MIL-STD-883, Method 3015)
 Latch up Current > 200 mA

Operating Range

Device	Range	Ambient Temperature	V _{CC} ^[8]
CY62157EV30LL	Ind'I/Auto-A	-40°C to +85°C	2.20V to 3.60V

Electrical Characteristics

Over the Operating Range

Parameter	Description	Test Conditions	45 ns (Ind'I/Auto-A)			Unit
			Min	Typ ^[2]	Max	
V _{OH}	Output HIGH Voltage	I _{OH} = -0.1 mA	2.0			V
		I _{OH} = -1.0 mA, V _{CC} ≥ 2.70V	2.4			V
V _{OL}	Output LOW Voltage	I _{OL} = 0.1 mA			0.4	V
		I _{OL} = 2.1mA, V _{CC} ≥ 2.70V			0.4	V
V _{IH}	Input HIGH Voltage	V _{CC} = 2.2V to 2.7V	1.8		V _{CC} + 0.3	V
		V _{CC} = 2.7V to 3.6V	2.2		V _{CC} + 0.3	V
V _{IL}	Input LOW Voltage	V _{CC} = 2.2V to 2.7V	-0.3		0.6	V
		V _{CC} = 2.7V to 3.6V	-0.3		0.8	V
I _{IX}	Input Leakage Current	GND ≤ V _I ≤ V _{CC}	-1		+1	μA
I _{OZ}	Output Leakage Current	GND ≤ V _O ≤ V _{CC} , Output Disabled	-1		+1	μA
I _{CC}	V _{CC} Operating Supply Current	f = f _{max} = 1/t _{RC}		18	25	mA
		f = 1 MHz	V _{CC} = V _{CCmax} I _{OUT} = 0 mA CMOS levels	1.8	3	
I _{SB1}	Automatic CE Power Down Current — CMOS Inputs	$\overline{CE}_1 \geq V_{CC} - 0.2V, CE_2 \leq 0.2V$ $V_{IN} \geq V_{CC} - 0.2V, V_{IN} \leq 0.2V$ f = f _{max} (Address and Data Only), f = 0 (OE, BHE, BLE and WE), V _{CC} = 3.60V		2	8	μA
I _{SB2} ^[9]	Automatic CE Power Down Current — CMOS Inputs	$\overline{CE}_1 \geq V_{CC} - 0.2V$ or $CE_2 \leq 0.2V,$ $V_{IN} \geq V_{CC} - 0.2V$ or $V_{IN} \leq 0.2V, f = 0, V_{CC} = 3.60V$		2	8	μA

Capacitance ^[10]

Parameter	Description	Test Conditions	Max	Unit
C _{IN}	Input Capacitance	T _A = 25°C, f = 1 MHz, V _{CC} = V _{CC(typ)}	10	pF
C _{OUT}	Output Capacitance		10	pF

Notes

- V_{IL(min)} = -2.0V for pulse durations less than 20 ns.
- V_{IH(max)} = V_{CC} + 0.75V for pulse durations less than 20 ns.
- Full device AC operation assumes a 100 μs ramp time from 0 to V_{cc(min)} and 200 μs wait time after V_{CC} stabilization.
- Only chip enables (CE₁ and CE₂), byte enables (BHE and BLE) and BYTE (48 TSOP I only) need to be tied to CMOS levels to meet the I_{SB2} / I_{CCDR} spec. Other inputs can be left floating.
- Tested initially and after any design or process changes that may affect these parameters.

Thermal Resistance ^[10]

Parameter	Description	Test Conditions	BGA	TSOP I	TSOP II	Unit
Θ_{JA}	Thermal Resistance (Junction to Ambient)	Still Air, soldered on a 3 × 4.5 inch, two-layer printed circuit board	72	74.88	76.88	°C/W
Θ_{JC}	Thermal Resistance (Junction to Case)		8.86	8.6	13.52	°C/W

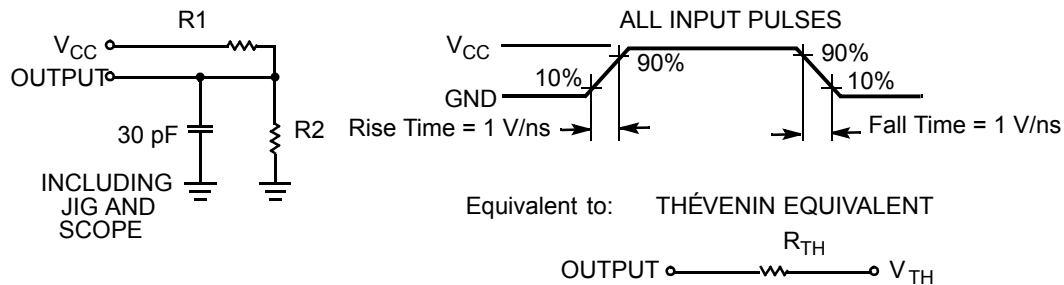
AC Test Loads and Waveforms
Figure 1. AC Test Loads and Waveforms

Parameters	2.5V	3.0V	Unit
R1	16667	1103	Ω
R2	15385	1554	Ω
R_{TH}	8000	645	Ω
V_{TH}	1.20	1.75	V

Data Retention Characteristics

Over the Operating Range

Parameter	Description	Conditions	Min	Typ ^[2]	Max	Unit
V_{DR}	V_{CC} for Data Retention		1.5			V
I_{CCDR} ^[9]	Data Retention Current	$V_{CC} = 1.5V, \overline{CE}_1 \geq V_{CC} - 0.2V,$ $CE_2 \leq 0.2V, V_{IN} \geq V_{CC} - 0.2V$ or $V_{IN} \leq 0.2V$		2	5	μA
t_{CDR} ^[10]	Chip Deselect to Data Retention Time		0			ns
t_R ^[11]	Operation Recovery Time		t_{RC}			ns

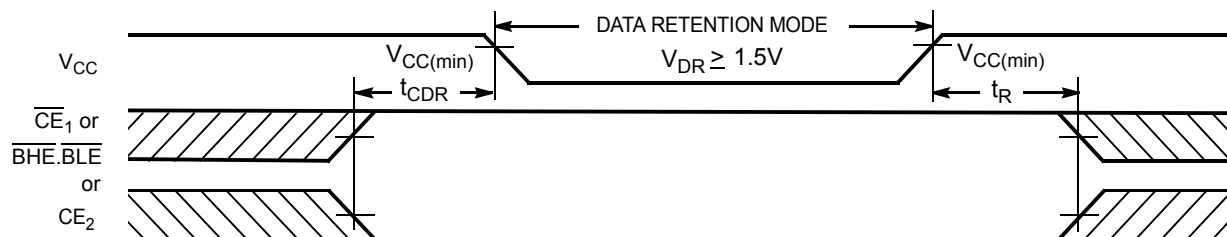
Data Retention Waveform ^[12]
Figure 2. Data Retention Waveform

Notes

 11. Full device operation requires linear V_{CC} ramp from V_{DR} to $V_{CC(min)} \geq 100 \mu s$ or stable at $V_{CC(min)} \geq 100 \mu s$.

 12. BHE.BLE is the AND of both BHE and BLE. Deselect the chip by either disabling chip enable signals or by disabling both \overline{BHE} and \overline{BLE} .

Switching Characteristics

Over the Operating Range^[13, 14]

Parameter	Description	45 ns (Ind'I/Auto-A)		Unit
		Min	Max	
Read Cycle				
t_{RC}	Read Cycle Time	45		ns
t_{AA}	Address to Data Valid		45	ns
t_{OHA}	Data Hold from Address Change	10		ns
t_{ACE}	\overline{CE}_1 LOW and CE_2 HIGH to Data Valid		45	ns
t_{DOE}	\overline{OE} LOW to Data Valid		22	ns
t_{LZOE}	\overline{OE} LOW to Low-Z ^[15]	5		ns
t_{HZOE}	\overline{OE} HIGH to High-Z ^[15, 16]		18	ns
t_{LZCE}	\overline{CE}_1 LOW and CE_2 HIGH to Low-Z ^[15]	10		ns
t_{HZCE}	\overline{CE}_1 HIGH and CE_2 LOW to High-Z ^[15, 16]		18	ns
t_{PU}	\overline{CE}_1 LOW and CE_2 HIGH to Power Up	0		ns
t_{PD}	\overline{CE}_1 HIGH and CE_2 LOW to Power Down		45	ns
t_{DBE}	$\overline{BLE}/\overline{BHE}$ LOW to Data Valid		45	ns
t_{LZBE}	$\overline{BLE}/\overline{BHE}$ LOW to Low-Z ^[15, 17]	5		ns
t_{HZBE}	$\overline{BLE}/\overline{BHE}$ HIGH to High-Z ^[15, 16]		18	ns
Write Cycle^[18]				
t_{WC}	Write Cycle Time	45		ns
t_{SCE}	\overline{CE}_1 LOW and CE_2 HIGH to Write End	35		ns
t_{AW}	Address Setup to Write End	35		ns
t_{HA}	Address Hold from Write End	0		ns
t_{SA}	Address Setup to Write Start	0		ns
t_{PWE}	\overline{WE} Pulse Width	35		ns
t_{BW}	$\overline{BLE}/\overline{BHE}$ LOW to Write End	35		ns
t_{SD}	Data Setup to Write End	25		ns
t_{HD}	Data Hold from Write End	0		ns
t_{HZWE}	\overline{WE} LOW to High-Z ^[15, 16]		18	ns
t_{LZWE}	\overline{WE} HIGH to Low-Z ^[15]	10		ns

Notes

13. Test conditions for all parameters other than tri-state parameters assume signal transition time of 3 ns or less, timing reference levels of $V_{CC(typ)}/2$, input pulse levels of 0 to $V_{CC(typ)}$, and output loading of the specified I_{OL}/I_{OH} as shown in the "AC Test Loads and Waveforms" on page 5.
14. AC timing parameters are subject to byte enable signals (BHE or BLE) not switching when chip is disabled. See application note AN13842 for further clarification.
15. At any temperature and voltage condition, t_{HZCE} is less than t_{LZCE} , t_{HZBE} is less than t_{LZBE} , t_{HZOE} is less than t_{LZOE} , and t_{HZWE} is less than t_{LZWE} for any device.
16. t_{HZOE} , t_{HZCE} , t_{HZBE} , and t_{HZWE} transitions are measured when the outputs enter a high-impedance state.
17. If both byte enables are toggled together, this value is 10 ns.
18. The internal write time of the memory is defined by the overlap of \overline{WE} , $\overline{CE} = V_{IL}$, \overline{BHE} , \overline{BLE} or both = V_{IL} , and $CE_2 = V_{IH}$. All signals must be active to initiate a write and any of these signals can terminate a write by going inactive. The data input setup and hold timing must be referenced to the edge of the signal that terminates the write.

Switching Waveforms

Read Cycle No. 1 (Address Transition Controlled)^[19, 20]

Figure 3. Read Cycle No. 1

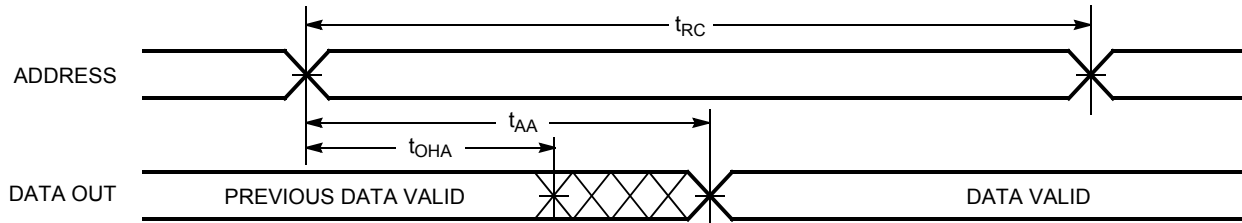

Read Cycle No. 2 (\overline{OE} Controlled)^[20, 21]

Figure 4. Read Cycle No. 2

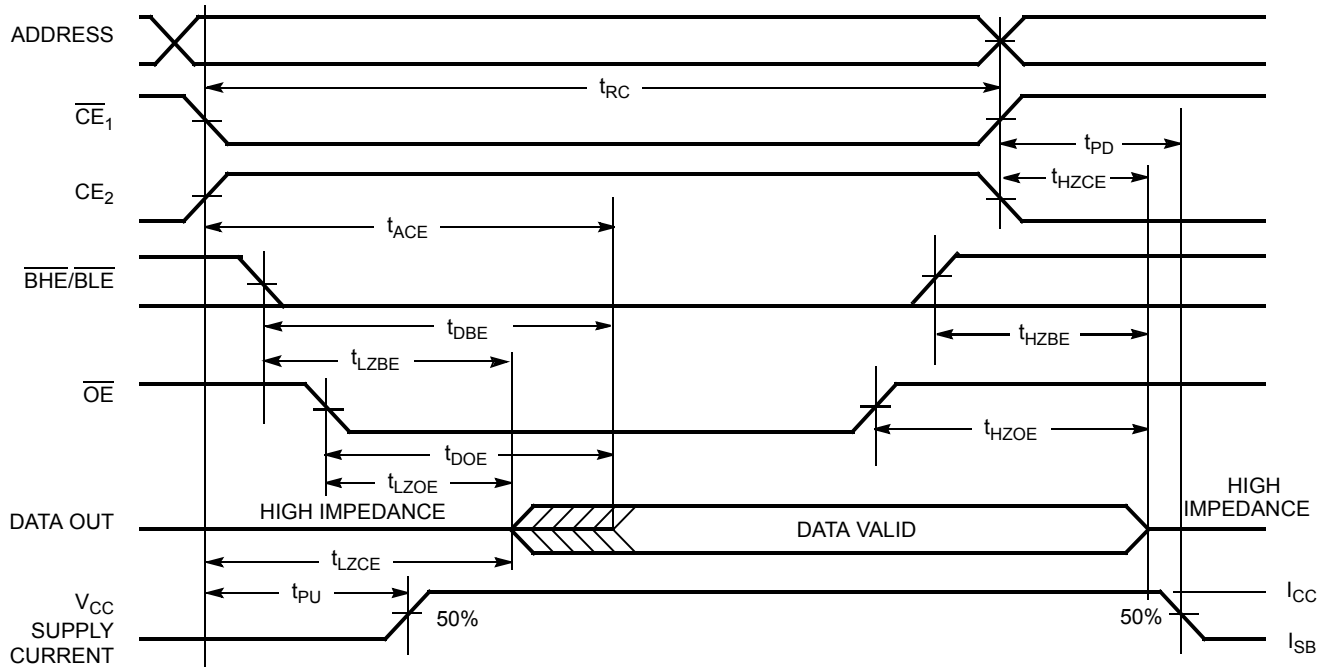

Notes

- 19. The device is continuously selected. \overline{OE} , $\overline{CE}_1 = V_{IL}$, \overline{BHE} , \overline{BLE} , or both = V_{IL} , and $CE_2 = V_{IH}$.
- 20. \overline{WE} is HIGH for read cycle.
- 21. Address valid before or similar to \overline{CE}_1 , \overline{BHE} , \overline{BLE} transition LOW and CE_2 transition HIGH.

Switching Waveforms (continued)

Write Cycle No. 1 (\overline{WE} Controlled)^[18, 22, 23]

Figure 5. Write Cycle No. 1

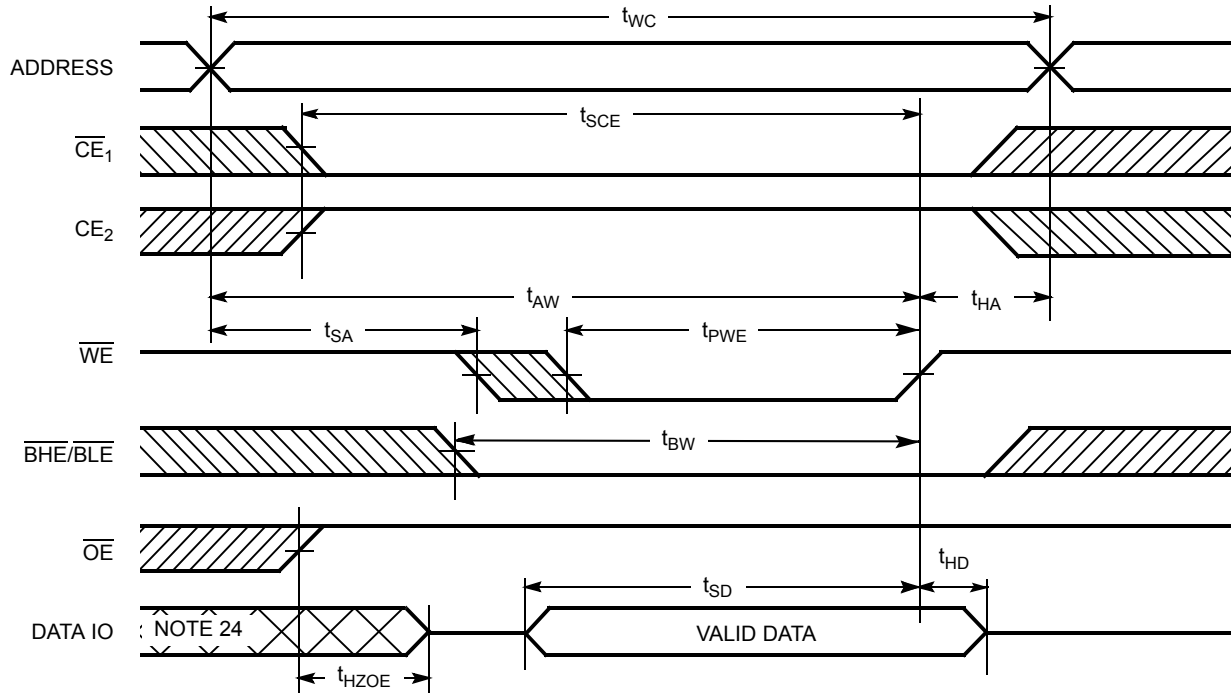

Write Cycle No. 2 (\overline{CE}_1 or CE_2 Controlled)^[18, 22, 23]

Figure 6. Write Cycle No. 1

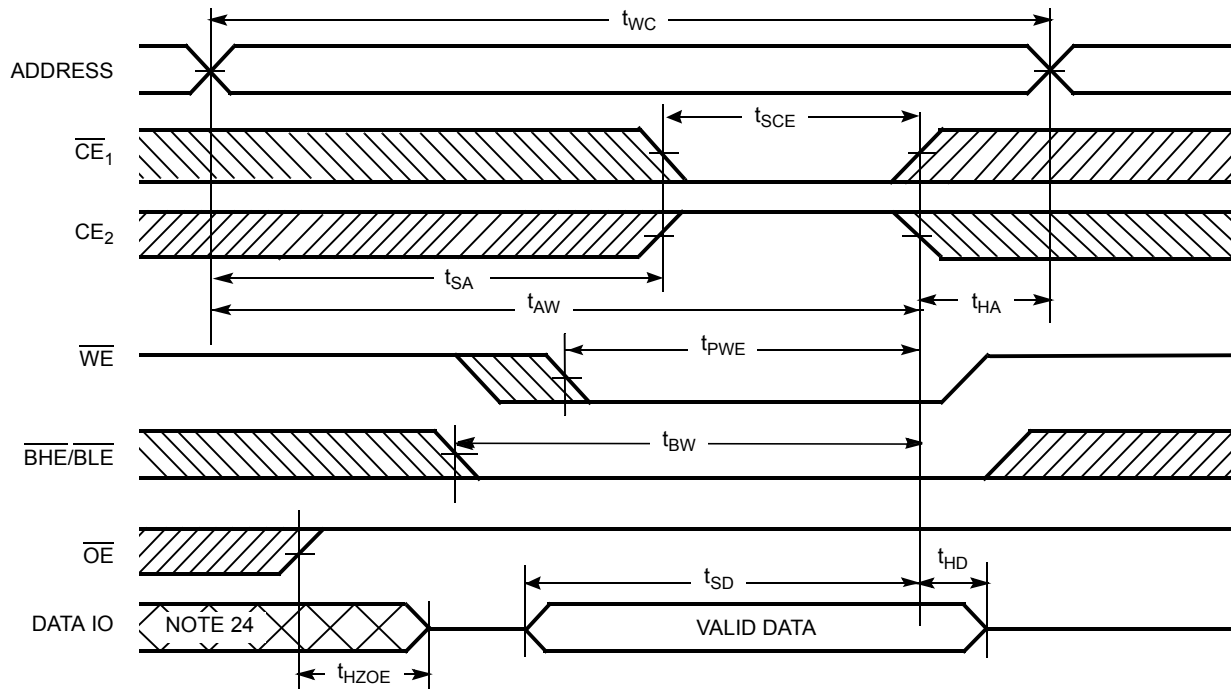

Notes

22. Data IO is high impedance if $\overline{OE} = V_{IH}$.

23. If \overline{CE}_1 goes HIGH and CE_2 goes LOW simultaneously with $\overline{WE} = V_{IH}$, the output remains in a high impedance state.

24. During this period, the IOs are in output state. Do not apply input signals.

Switching Waveforms (continued)

Write Cycle No. 3 (\overline{WE} Controlled, \overline{OE} LOW)^[23]

Figure 7. Write Cycle No. 3

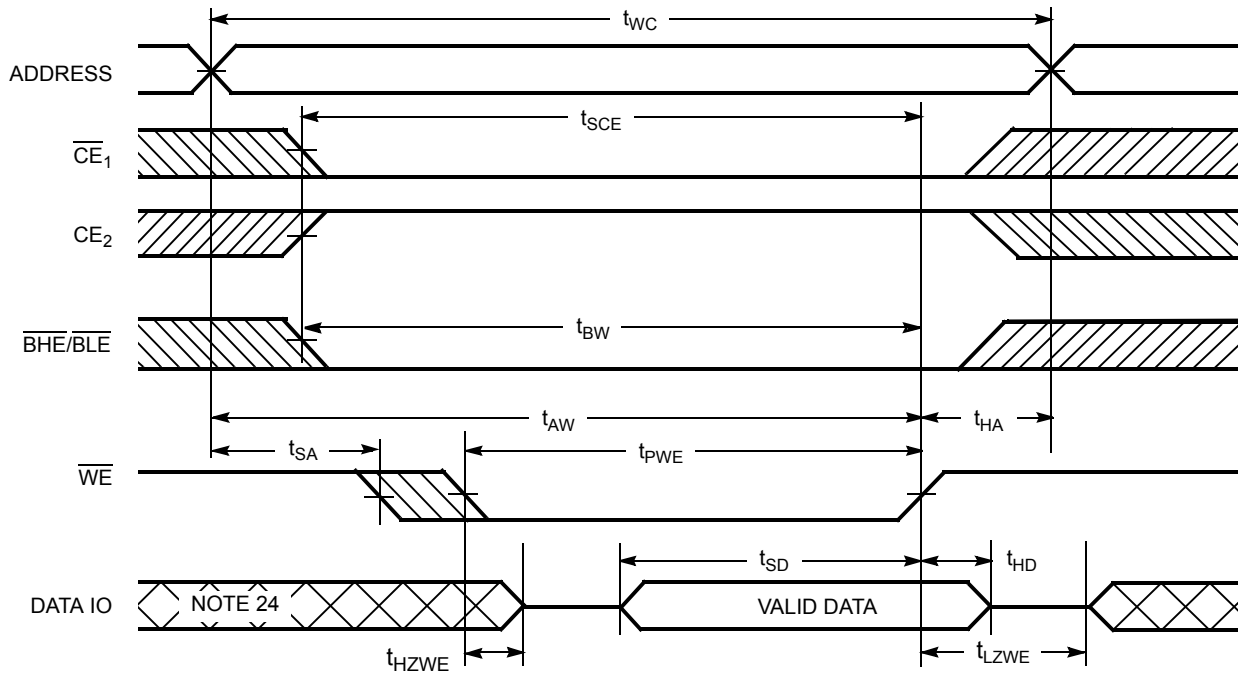

Write Cycle No. 4 ($\overline{BHE}/\overline{BLE}$ Controlled, \overline{OE} LOW)^[23]

Figure 8. Write Cycle No. 4

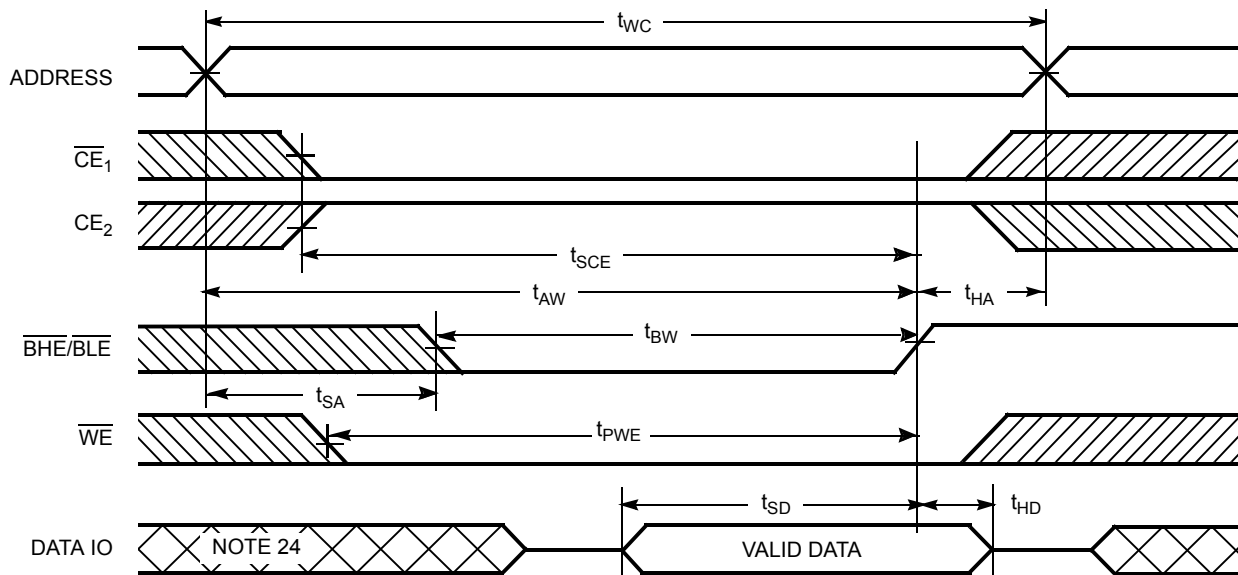

Truth Table

\overline{CE}_1	\overline{CE}_2	\overline{WE}	\overline{OE}	\overline{BHE}	\overline{BLE}	Inputs/Outputs	Mode	Power
H	X	X	X	X	X	High-Z	Deselect/Power Down	Standby (I_{SB})
X	L	X	X	X	X	High-Z	Deselect/Power Down	Standby (I_{SB})
X	X	X	X	H	H	High-Z	Deselect/Power Down	Standby (I_{SB})
L	H	H	L	L	L	Data Out (IO_0 - IO_{15})	Read	Active (I_{CC})
L	H	H	L	H	L	Data Out (IO_0 - IO_7); High-Z (IO_8 - IO_{15})	Read	Active (I_{CC})
L	H	H	L	L	H	High-Z (IO_0 - IO_7); Data Out (IO_8 - IO_{15})	Read	Active (I_{CC})
L	H	H	H	L	H	High-Z	Output Disabled	Active (I_{CC})
L	H	H	H	H	L	High-Z	Output Disabled	Active (I_{CC})
L	H	H	H	L	L	High-Z	Output Disabled	Active (I_{CC})
L	H	L	X	L	L	Data In (IO_0 - IO_{15})	Write	Active (I_{CC})
L	H	L	X	H	L	Data In (IO_0 - IO_7); High-Z (IO_8 - IO_{15})	Write	Active (I_{CC})
L	H	L	X	L	H	High-Z (IO_0 - IO_7); Data In (IO_8 - IO_{15})	Write	Active (I_{CC})

Ordering Information

Speed (ns)	Ordering Code	Package Diagram	Package Type	Operating Range
45	CY62157EV30LL-45BVI	51-85150	48-ball Very Fine Pitch Ball Grid Array	Industrial
	CY62157EV30LL-45BVXI	51-85150	48-ball Very Fine Pitch Ball Grid Array (Pb-free)	
	CY62157EV30LL-45ZSXI	51-85087	44-pin Thin Small Outline Package Type II (Pb-free)	
	CY62157EV30LL-45ZXI	51-85183	48-pin Thin Small Outline Package Type I (Pb-free)	
45	CY62157EV30LL-45BVXA	51-85150	48-ball Very Fine Pitch Ball Grid Array (Pb-free)	Automotive-A
	CY62157EV30LL-45ZSXA	51-85087	44-pin Thin Small Outline Package Type II (Pb-free)	

Contact your local Cypress sales representative for availability of these parts.

Package Diagrams

Figure 9. 48-Pin VFBGA (6 x 8 x 1 mm), 51-85150

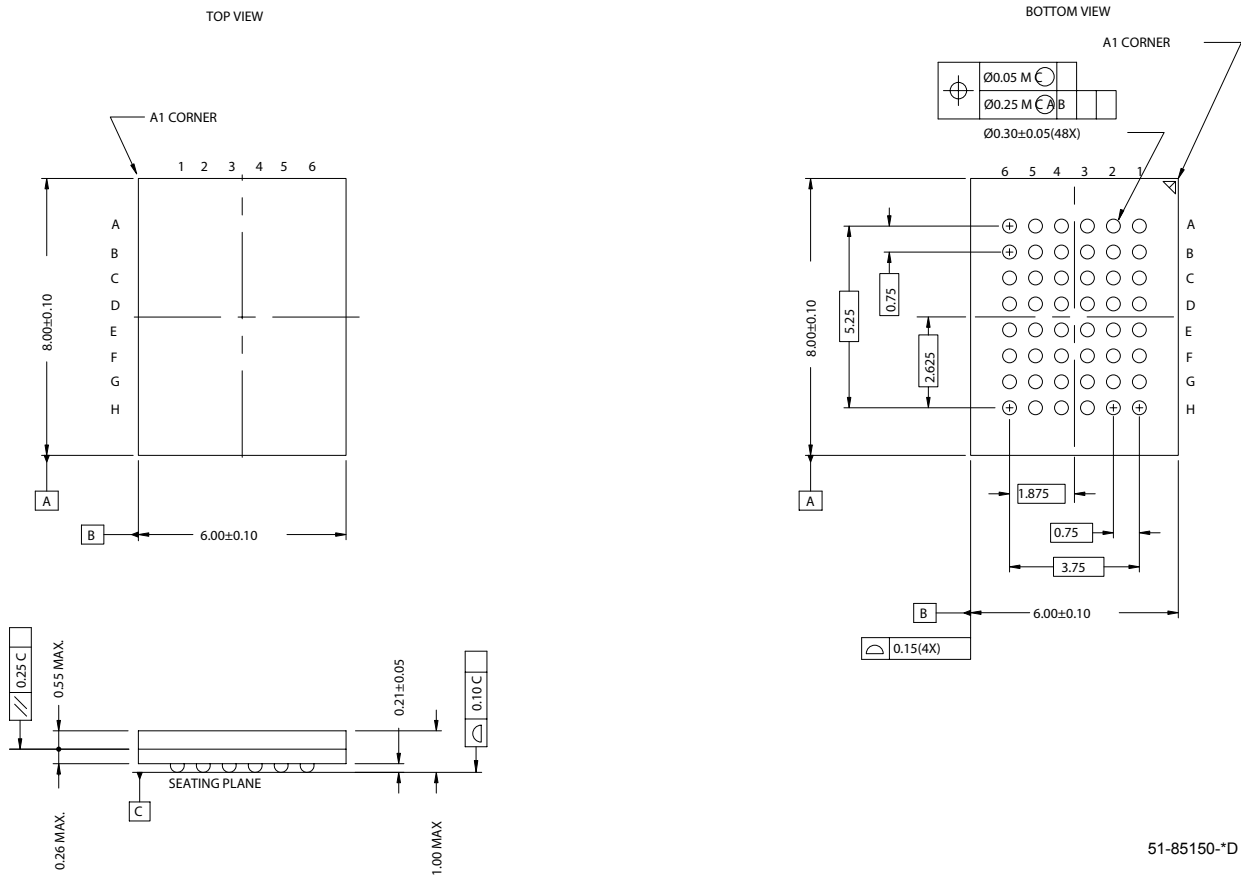

51-85150-*D

Package Diagrams (continued)

Figure 10. 44-Pin TSOP II, 51-85087

DIMENSION IN MM (INCH)
MAX
MIN

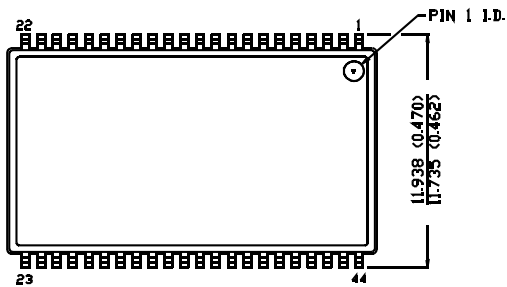

TOP VIEW

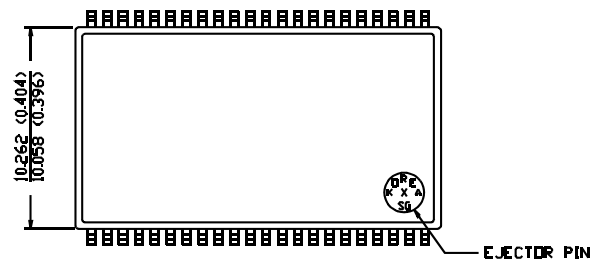

BOTTOM VIEW

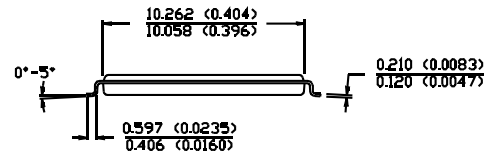
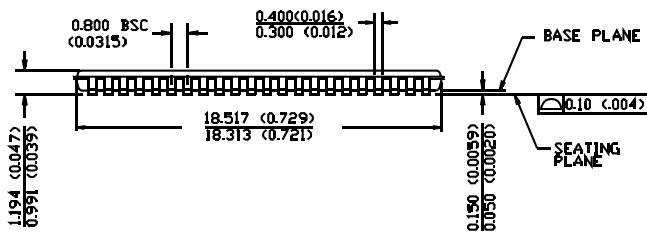

51-85087-A

Package Diagrams (continued)

Figure 11. 48-Pin TSOP I (12 mm x 18.4 mm x 1.0 mm), 51-85183

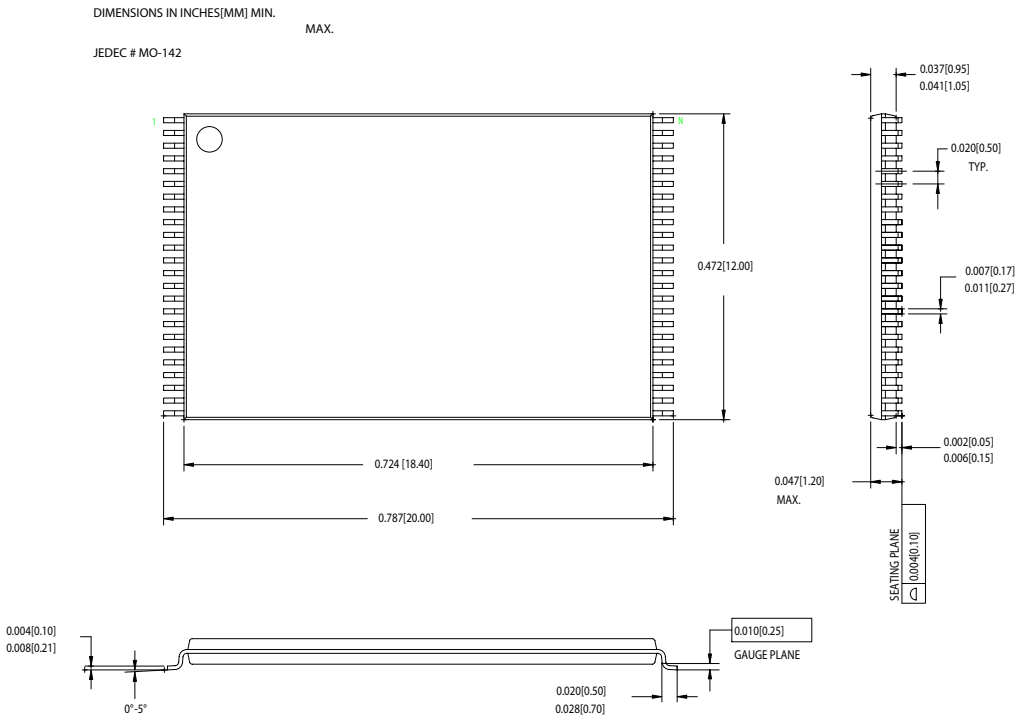

51-85183-A

MoBL is a registered trademark, and More Battery Life is a trademark of Cypress Semiconductor. All product and company names mentioned in this document are the trademarks of their respective holders.

Document History Page

Document Title: CY62157EV30 MoBL®, 8-Mbit (512K x 16) Static RAM Document Number: 38-05445				
REV.	ECN NO.	Issue Date	Orig. of Change	Description of Change
**	202940	See ECN	AJU	New Data Sheet
*A	291272	See ECN	SYT	<p>Converted from Advance Information to Preliminary</p> <p>Removed 48-TSOP I Package and the associated footnote</p> <p>Added footnote stating 44 TSOP II Package has only one CE on Page # 2</p> <p>Changed V_{CC} stabilization time in footnote #7 from 100 μs to 200 μs</p> <p>Changed I_{CCDR} from 4 to 4.5 μA</p> <p>Changed t_{OHA} from 6 to 10 ns for both 35 and 45 ns Speed Bins</p> <p>Changed t_{DOE} from 15 to 18 ns for 35 ns Speed Bin</p> <p>Changed t_{HZOE}, t_{HZBE} and t_{HZWE} from 12 and 15 ns to 15 and 18 ns for 35 and 45 ns Speed Bins respectively</p> <p>Changed t_{HZCE} from 12 and 15 ns to 18 and 22 ns for 35 and 45 ns Speed Bins respectively</p> <p>Changed t_{SCE}, t_{AW} and t_{BW} from 25 and 40 ns to 30 and 35 ns for 35 and 45 ns Speed Bins respectively</p> <p>Changed t_{SD} from 15 and 20 ns to 18 and 22 ns for 35 and 45 ns Speed Bins respectively</p> <p>Added Lead-Free Package Information</p>
*B	444306	See ECN	NXR	<p>Converted from Preliminary to Final.</p> <p>Changed ball E3 from DNU to NC</p> <p>Removed redundant footnote on DNU.</p> <p>Removed 35 ns speed bin</p> <p>Removed "L" bin</p> <p>Added 48 pin TSOP I package</p> <p>Added Automotive product information.</p> <p>Changed the I_{CC} Typ value from 16 mA to 18 mA and I_{CC} Max value from 28 mA to 25 mA for test condition f = fax = 1/t_{RC}.</p> <p>Changed the I_{CC} Max value from 2.3 mA to 3 mA for test condition f = 1MHz.</p> <p>Changed the I_{SB1} and I_{SB2} Max value from 4.5 μA to 8 μA and Typ value from 0.9 μA to 2 μA respectively.</p> <p>Modified ISB₁ test condition to include $\overline{\text{BHE}}$, $\overline{\text{BLE}}$</p> <p>Updated Thermal Resistance table.</p> <p>Changed Test Load Capacitance from 50 pF to 30 pF.</p> <p>Added Typ value for I_{CCDR}.</p> <p>Changed the I_{CCDR} Max value from 4.5 μA to 5 μA</p> <p>Corrected t_R in Data Retention Characteristics from 100 μs to t_{RC} ns.</p> <p>Changed t_{LZOE} from 3 to 5</p> <p>Changed t_{LZCE} from 6 to 10</p> <p>Changed t_{HZCE} from 22 to 18</p> <p>Changed t_{LZBE} from 6 to 5</p> <p>Changed t_{PWE} from 30 to 35</p> <p>Changed t_{SD} from 22 to 25</p> <p>Changed t_{LZWE} from 6 to 10</p> <p>Added footnote #15</p> <p>Updated the ordering Information and replaced the Package Name column with Package Diagram.</p>
*C	467052	See ECN	NXR	<p>Modified Data sheet to include x8 configurability.</p> <p>Updated the Ordering Information table</p>
*D	925501	See ECN	VKN	<p>Removed Automotive-E information</p> <p>Added Preliminary Automotive-A information</p> <p>Added footnote #10 related to I_{SB2} and I_{CCDR}</p> <p>Added footnote #15 related AC timing parameters</p>
*E	1045801	See ECN	VKN	<p>Converted Automotive-A specs from preliminary to final</p> <p>Updated footnote #9</p>