



**N-Channel Enhancement-Mode Vertical DMOS FETs**

**Ordering Information**

BV <sub>DSS</sub> / BV <sub>DGS</sub>	R <sub>DS(ON)</sub> (max)	I <sub>D(ON)</sub> (min)	Order Number / Package	
			TO-92	Die†
400V	35Ω	250mA	VN0540N3	VN0540ND

† MIL visual screening available

**7**

**Features**

- Free from secondary breakdown
- Low power drive requirement
- Ease of paralleling
- Low C<sub>ISS</sub> and fast switching speeds
- Excellent thermal stability
- Integral Source-Drain diode
- High input impedance and high gain
- Complementary N- and P-channel devices

**Advanced DMOS Technology**

These enhancement-mode (normally-off) transistors utilize a vertical DMOS structure and Supertex's well-proven silicon-gate manufacturing process. This combination produces devices with the power handling capabilities of bipolar transistors and with the high input impedance and positive temperature coefficient inherent in MOS devices. Characteristic of all MOS structures, these devices are free from thermal runaway and thermally-induced secondary breakdown.

Supertex's vertical DMOS FETs are ideally suited to a wide range of switching and amplifying applications where high breakdown voltage, high input impedance, low input capacitance, and fast switching speeds are desired.

**Applications**

- Motor controls
- Converters
- Amplifiers
- Switches
- Power supply circuits
- Drivers (relays, hammers, solenoids, lamps, memories, displays, bipolar transistors, etc.)

**Package Options**

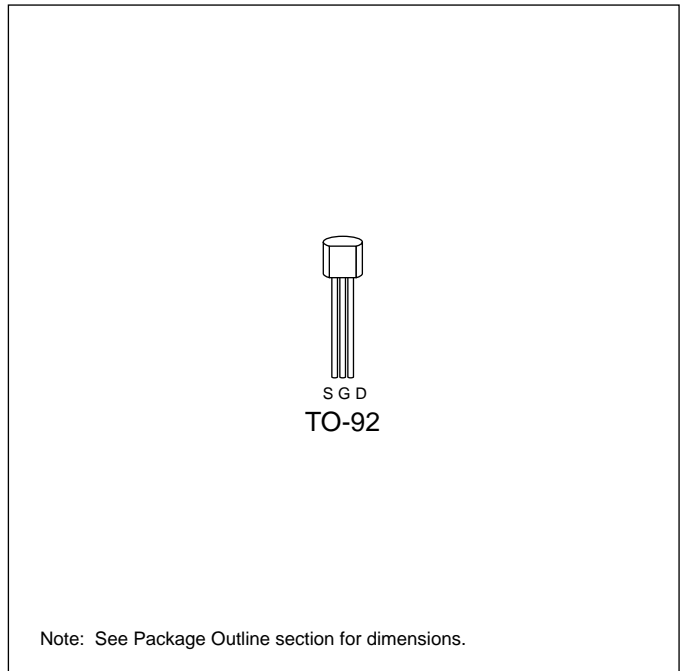

Note: See Package Outline section for dimensions.

**Absolute Maximum Ratings**

Drain-to-Source Voltage	BV <sub>DSS</sub>
Drain-to-Gate Voltage	BV <sub>DGS</sub>
Gate-to-Source Voltage	± 20V
Operating and Storage Temperature	-55°C to +150°C
Soldering Temperature*	300°C

\* Distance of 1.6 mm from case for 10 seconds.

## Thermal Characteristics

Package	$I_D$ (continuous)*	$I_D$ (pulsed)	Power Dissipation @ $T_C = 25^\circ\text{C}$	$\theta_{jc}$ $^\circ\text{C/W}$	$\theta_{ja}$ $^\circ\text{C/W}$	$I_{DR}^*$	$I_{DRM}$
TO-92	100mA	400mA	1.0W	125	170	100mA	400mA

\*  $I_D$  (continuous) is limited by max rated  $T_j$ .

## Electrical Characteristics (@ $25^\circ\text{C}$ unless otherwise specified)

Symbol	Parameter	Min	Typ	Max	Unit	Conditions
$BV_{DSS}$	Drain-to-Source Breakdown Voltage	400			V	$V_{GS} = 0V, I_D = 1mA$
$V_{GS(th)}$	Gate Threshold Voltage	2		4	V	$V_{GS} = V_{DS}, I_D = 1mA$
$\Delta V_{GS(th)}$	Change in $V_{GS(th)}$ with Temperature		-3.5	-4.5	mV/ $^\circ\text{C}$	$V_{GS} = V_{DS}, I_D = 1mA$
$I_{GSS}$	Gate Body Leakage			100	nA	$V_{GS} = \pm 20V, V_{DS} = 0V$
$I_{DSS}$	Zero Gate Voltage Drain Current			10	$\mu\text{A}$	$V_{GS} = 0V, V_{DS} = \text{Max Rating}$
				500		$V_{GS} = 0V, V_{DS} = 0.8 \text{ Max Rating}$ $T_A = 125^\circ\text{C}$
$I_{D(ON)}$	ON-State Drain Current		300		mA	$V_{GS} = 5V, V_{DS} = 25V$
		250	340			$V_{GS} = 10V, V_{DS} = 25V$
$R_{DS(ON)}$	Static Drain-to-Source ON-State Resistance		30		$\Omega$	$V_{GS} = 5V, I_D = 20mA$
			25	35		$V_{GS} = 10V, I_D = 0.1A$
$\Delta R_{DS(ON)}$	Change in $R_{DS(ON)}$ with Temperature		0.9	1.5	%/ $^\circ\text{C}$	$V_{GS} = 10V, I_D = 0.1A$
$G_{FS}$	Forward Transconductance	100	180		m $\Omega$	$V_{DS} = 25V, I_D = 0.1A$
$C_{ISS}$	Input Capacitance		45	55	pF	$V_{GS} = 0V, V_{DS} = 25V$ $f = 1 \text{ MHz}$
$C_{OSS}$	Common Source Output Capacitance		8	10		
$C_{RSS}$	Reverse Transfer Capacitance		2	5		
$t_{d(ON)}$	Turn-ON Delay Time			10	ns	$V_{DD} = 25V, I_D = 250mA$ $R_{GEN} = 25\Omega$
$t_r$	Rise Time			10		
$t_{d(OFF)}$	Turn-OFF Delay Time			10		
$t_f$	Fall Time			10		
$V_{SD}$	Diode Forward Voltage Drop		0.8		V	$V_{GS} = 0V, I_{SD} = 0.5A$
$t_{rr}$	Reverse Recovery Time		400		ns	$V_{GS} = 0V, I_{SD} = 0.5A$

### Notes:

- All D.C. parameters 100% tested at  $25^\circ\text{C}$  unless otherwise stated. (Pulse test: 300 $\mu\text{s}$  pulse, 2% duty cycle.)
- All A.C. parameters sample tested.

## Switching Waveforms and Test Circuit

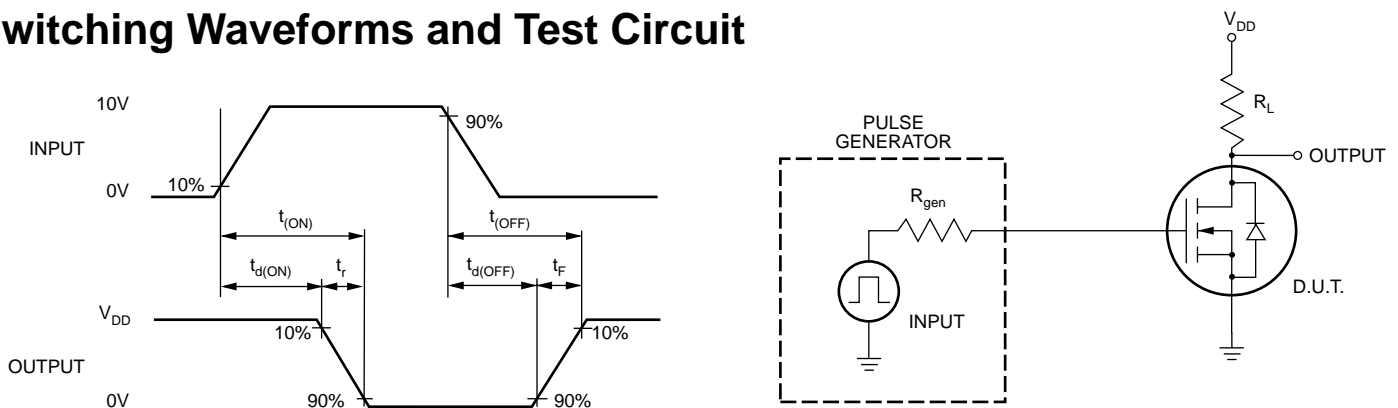

# Typical Performance Curves

7

Output Characteristics

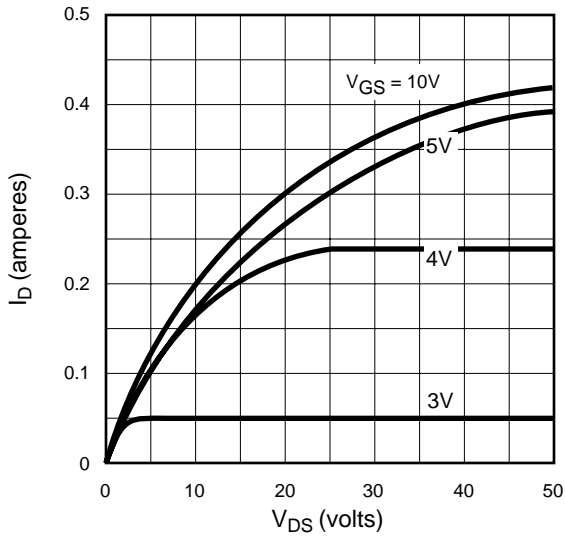

Saturation Characteristics

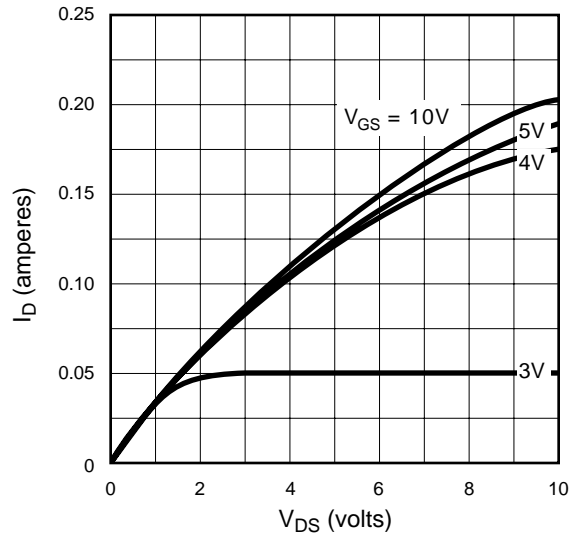

Transconductance vs. Drain Current

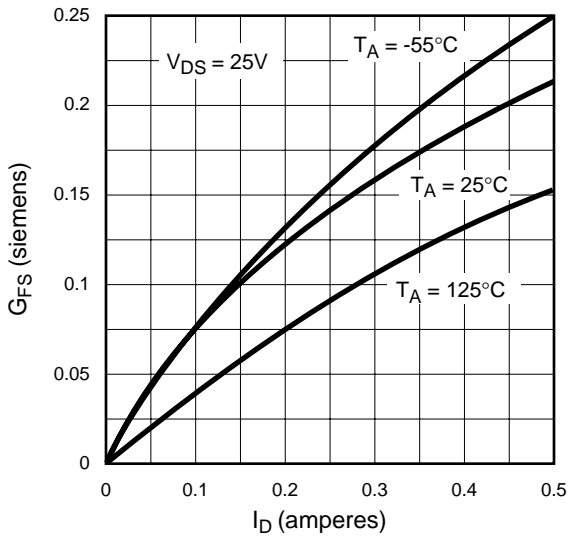

Power Dissipation vs. Case Temperature

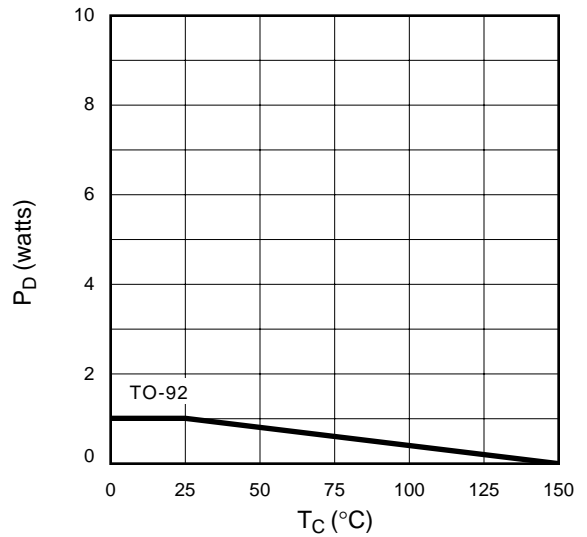

Maximum Rated Safe Operating Area

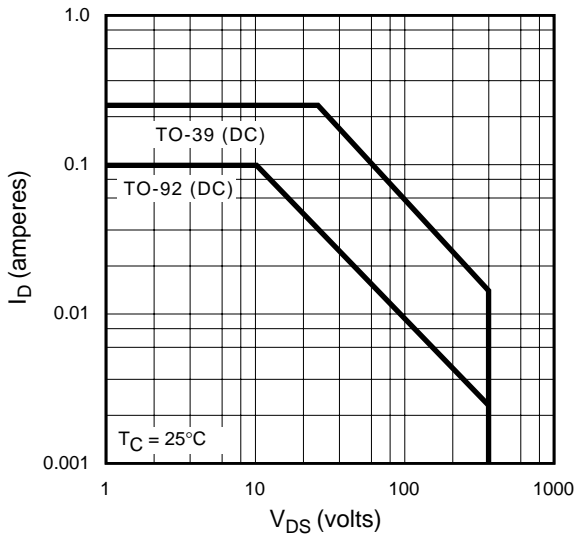

Thermal Response Characteristics

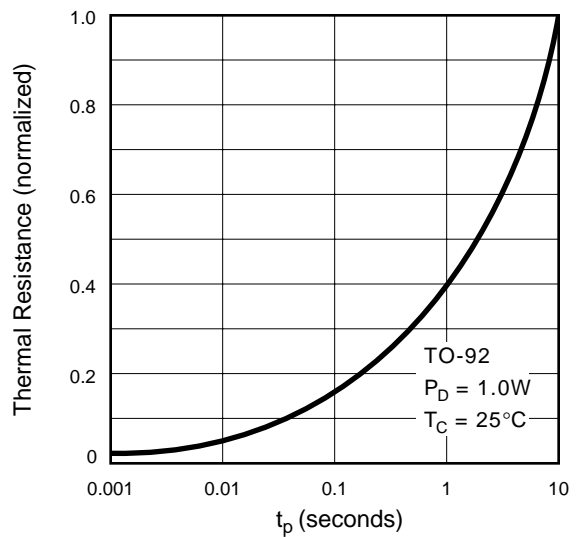

# Typical Performance Curves

BV<sub>DSS</sub> Variation with Temperature

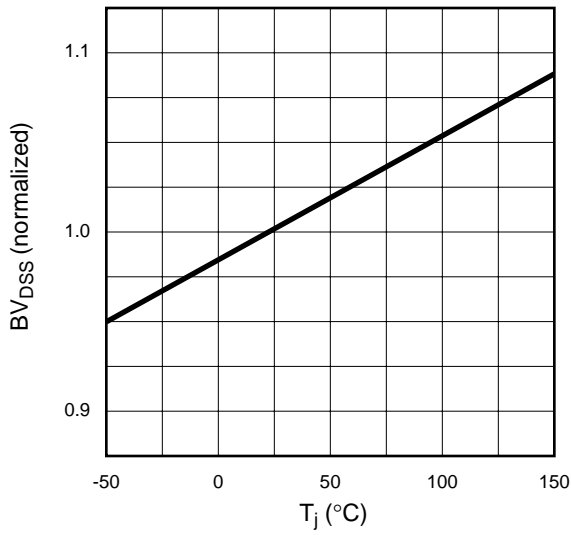

On-Resistance vs. Drain Current

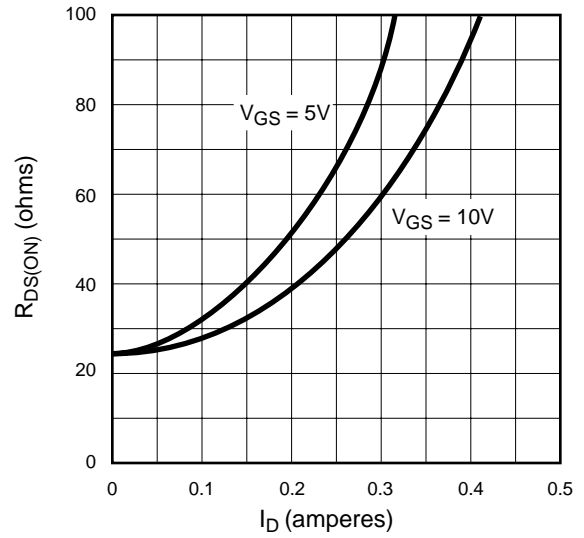

Transfer Characteristics

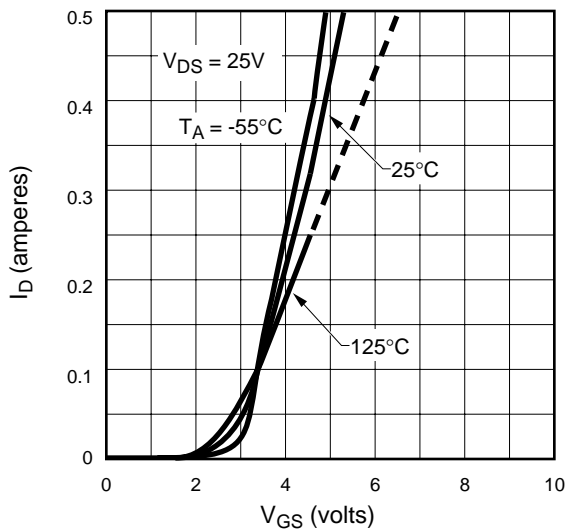

V<sub>(th)</sub> and R<sub>DS</sub> Variation with Temperature

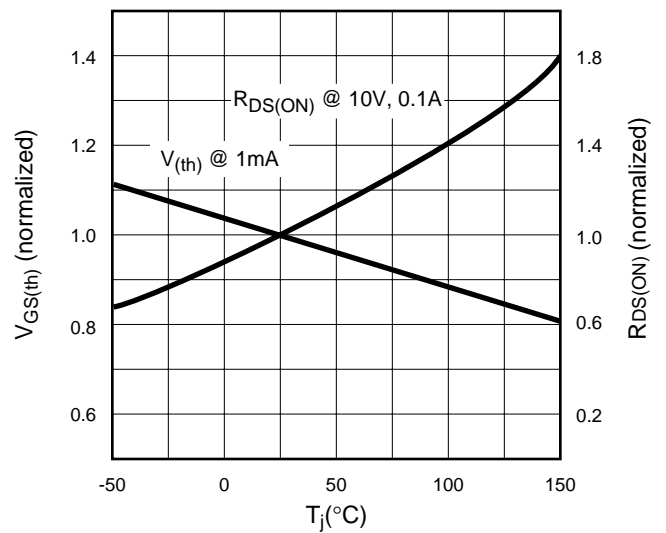

Capacitance vs. Drain-to-Source Voltage

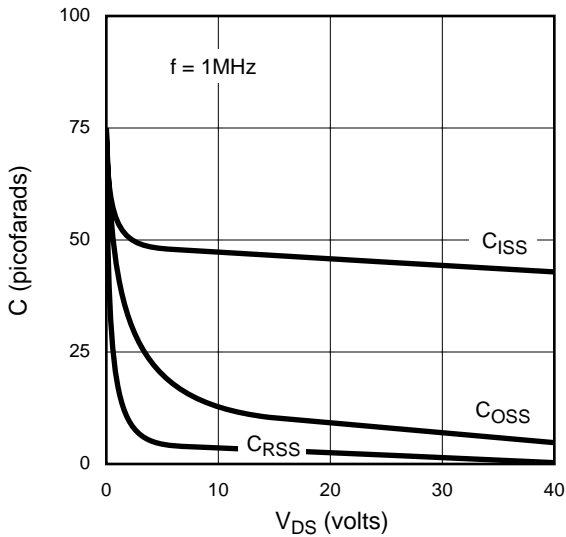

Gate Drive Dynamic Characteristics

