

<p style="text-align: center;">TECHNICAL SPECIFICATION</p> <p style="text-align: center;">MODEL NO. : V26L8060AA</p>
--

Customer's Confirmation

Date _____

By _____

PVI's Confirmation

Confirmed By _____

Prepared By _____

PRIME VIEW INTERNATIONAL CO.,LTD.
3,LI SHIN RD. 1,SCIENCE-BASED INDUSTRIAL
PARK,HSINCHU,TAIWAN,R.O.C.
<http://www.pvi.com.tw>

Date : Apr. 7, 2000

This technical specification is subject to change without notice.
Please contact with PVI for more detail information about this specification sheet.

TECHNICAL SPECIFICATION**CONTENTS**

<i>NO.</i>	<i>ITEM</i>	<i>PAGE</i>
-	Cover(V26L8060AA)	1
-	Contents	2
1	Application	3
2	Features	3
3	Mechanical Specifications	3
4	Mechanical Drawing of TFT-LCD module	4
5	Input / Output Terminals	5
6	Absolute Maximum Ratings	7
7	Electrical Characteristics	7
8	Optical Characteristics	12
9	Reliability Test	15
10	Block Diagram	16
-	Revision History	17

1. Application

This data sheet applies to a color TFT LCD module, V26L8060AA.

V26L8060AA module applies to note-book PC, sub-note-book PC and other O/A products which require high quality flat panel display. **This module is not designed for aerospace, avionics, medical, F/A, transportation, car or any other products which require extreme level of reliability.**

Prime View assume no responsibility for any damage resulting from the use of the device which dose not comply with the instructions and the precautions in these specification sheet.

2. Features

- . Amorphous silicon TFT LCD panel with back-light unit
- . Pixel in stripe configuration
- . Slim and compact, designed for O/A application
- . Display Colors : 262,144 colors
- . Optimum Viewing Direction : 6 o'clock
- . 3.3V LVDS interface standard : DS90CF364 as receiver
- . +3.3V DC supply voltage for TFT LCD panel driving
- . Back-light driving DC/AC inverter not included in this module

3. Mechanical Specifications

Parameter	Specifications	Unit
Screen Size	26.4(diagonal)	cm
	10.4 (diagonal)	inch
Display Format	800×(R, G, B)×600	dot
Display Colors	262,144	
Active Area	211.2(H)×158.4 (V)	mm
Pixel Pitch	0.264 (H)×0.264 (V)	mm
Pixel Configuration	Stripe	
Outline Dimension	238.6 (w)×171.0(H)×6.0 max (D)	mm
Weight	312(typ.)	g
Back-light	Single CCFL, side-light type	
Surface treatment	Anti-glare and hard-coating	
Display mode	Normally white	

4. Mechanical Drawing of TFT-LCD Module

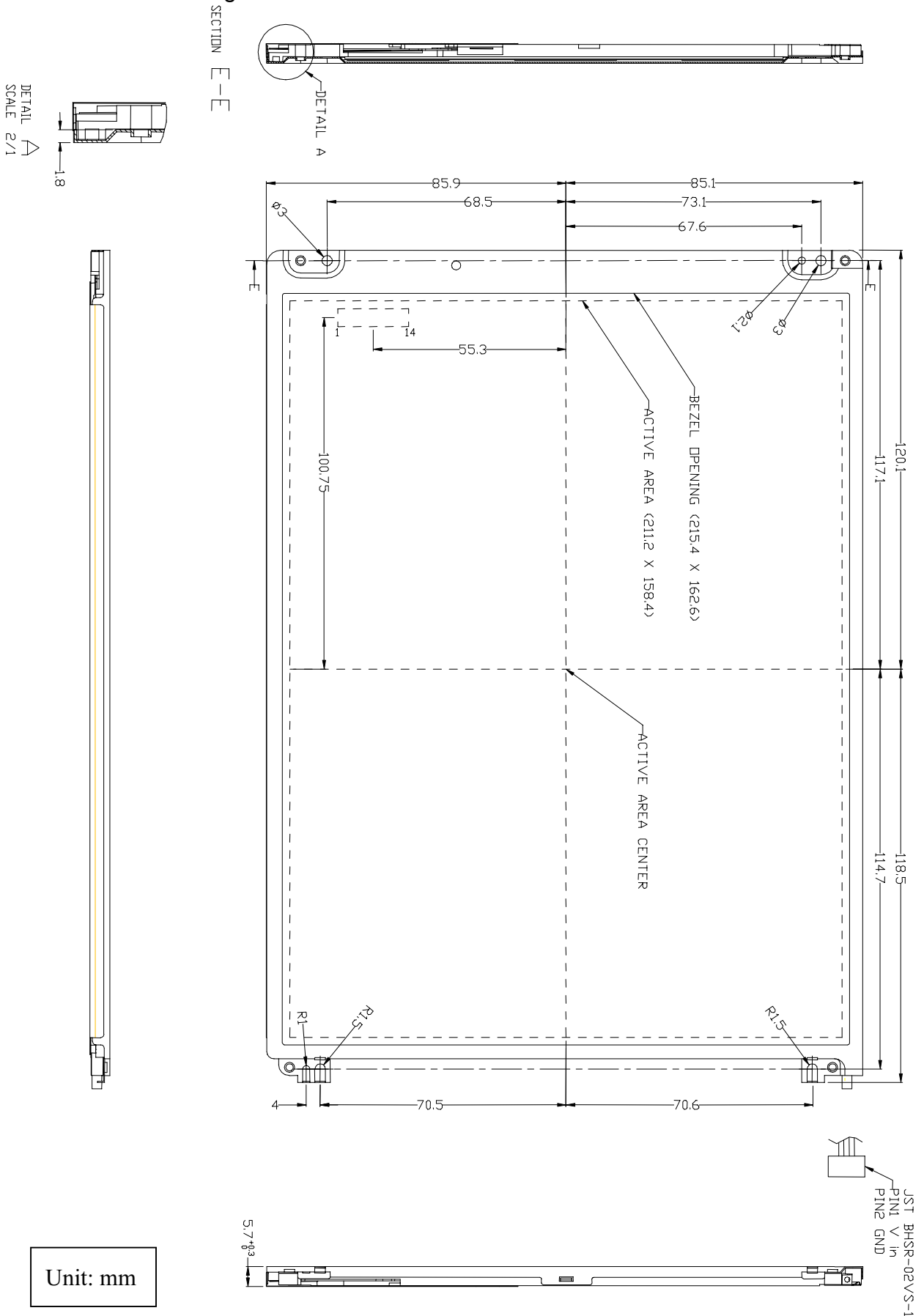

Unit: mm

5. Input Terminals

5-1) TFT-LCD Panel Driving

Connector type : TBD

Pin No.	Symbol	Function	Remark
1	VDD	Power supply : +3.3V	
2	VDD	Power supply : +3.3V	
3	GND		
4	GND		
5	IN0-	Pixel data Transmission pair 0 (negative -)	
6	IN0+	Pixel data Transmission pair 0 (positive +)	
7	IN1-	Pixel data Transmission pair 1 (negative -)	
8	IN1+	Pixel data Transmission pair 1 (positive +)	
9	IN2-	Pixel data Transmission pair 2 (negative -)	
10	IN2+	Pixel data Transmission pair 2 (positive +)	
11	CLK-	Sampling Clock (negative -)	
12	CLK+	Sampling Clock (positive +)	
13	GND		
14	GND		

Recommended Transmitter(DS90C*363 of National Semiconductor) to V26L8060AA interface Assignment :

Input terminal of DS 90C*363		Graphic controller output signal		Output signal symbol	To V26L8060AA interface terminal(Symbol)
Symbol	No.	Symbol	Function		
TIN0	44	R0	Red pixel data (LSB)	Tout0- Tout0+	No.5 : IN0- No.6 : IN0+
TIN1	45	R1	Red pixel data		
TIN2	47	R2	Red pixel data		
TIN3	48	R3	Red pixel data		
TIN4	1	R4	Red pixel data		
TIN5	3	R5	Red pixel data(MSB)		
TIN6	4	G0	Green pixel data (LSB)	Tout1- Tout1+	No.7 : IN1- No.8 : IN1+
TIN7	6	G1	Green pixel data		
TIN8	7	G2	Green pixel data		
TIN9	9	G3	Green pixel data		
TIN10	10	G4	Green pixel data		
TIN11	12	G5	Green pixel data(MSB)		
TIN12	13	B0	Blue pixel data(LSB)	Tout2- Tout2+	No.9 : IN2- No.10 : IN2+
TIN13	15	B1	Blue pixel data		
TIN14	16	B2	Blue pixel data		
TIN15	18	B3	Blue pixel data		
TIN16	19	B4	Blue pixel data		
TIN17	20	B5	Blue pixel data(MSB)		
TIN18	22	NC	no connection		
TIN19	23	NC	no connection		
TIN20	25	ENAB	Compound Synchronization signal		
CLK in	26	NCLK	Data sampling clock	TCLK out- TCLK out+	No.11 : CLK IN- No.12 : CLK IN+

Data stream of IN0-/+, IN1-/+, and IN2-/+, for V26L8060AA

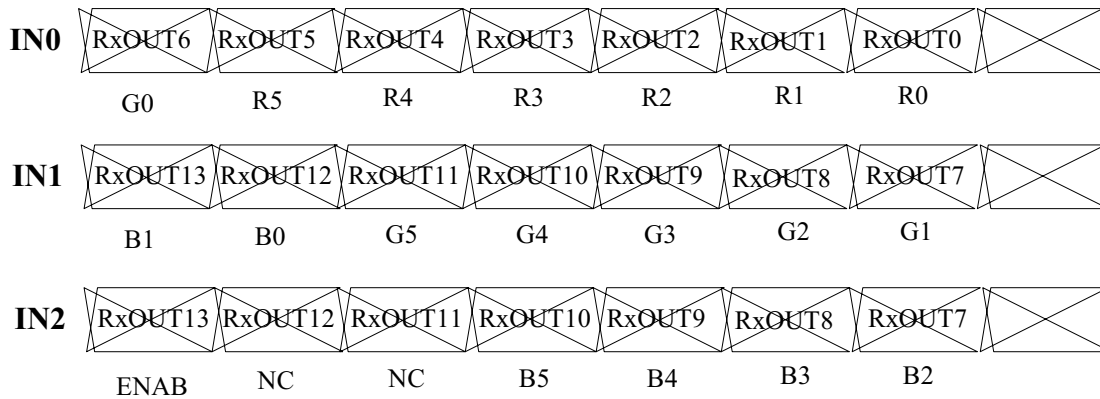

LVDS Interface Block Diagram

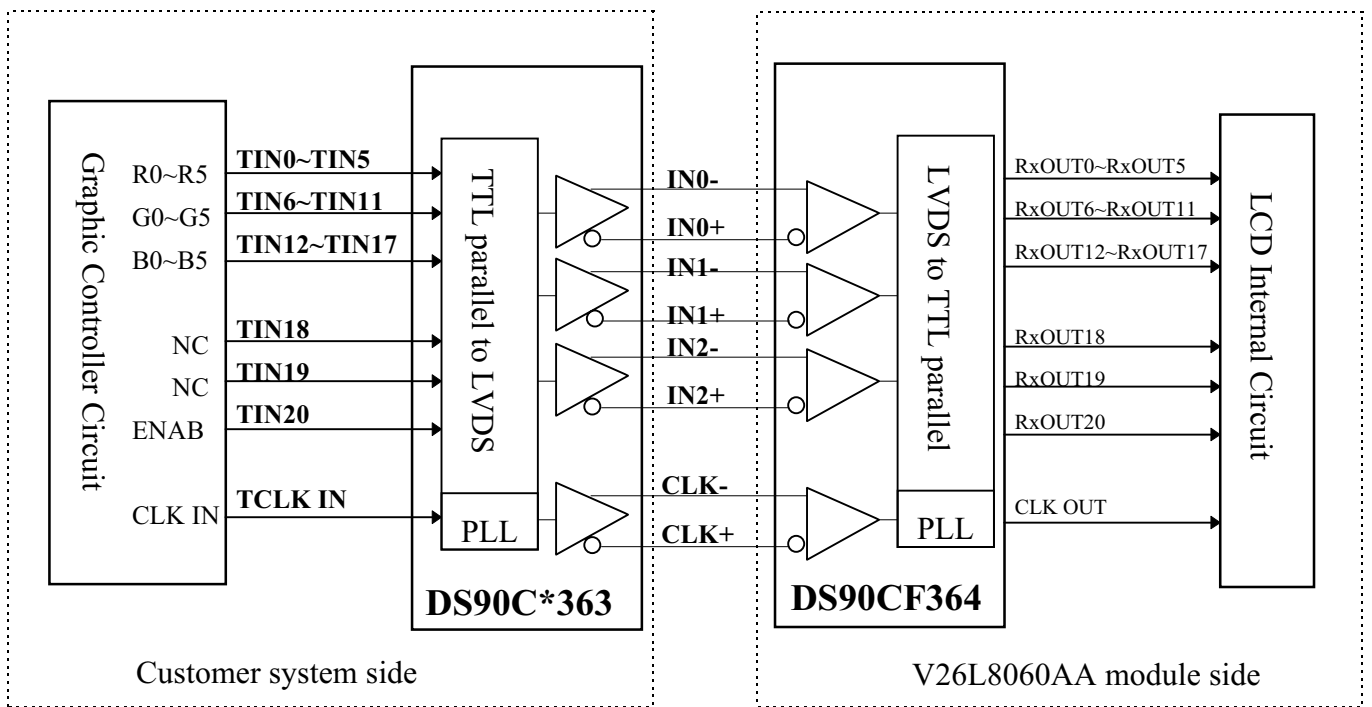

5-2) Backlight driving

Connector type : "BHR-02VS-1" of Japan Solderless Terminal MFG Co. LTD

PIN NO.	Symbol	Description	Remark
1	VL1	Input Voltage(High)	
2	VL2	Input Voltage(Low)	

6. Absolute Maximum Ratings:

GND=0V, Ta=25°C

Parameters	Symbol	MIN.	MAX.	Unit	Remark
Supply Voltage	VDD	-0.3	+4.0	V	
Input Signals Voltage	V _{IN}	-0.3	VDD+0.3	V	Note 6-1
Backlight Driving Voltage	V _L	-	2000	V	
Backlight Driving Frequency	F _L	0	100	KHz	
Storage Temperature	T _{ST}	-20	+60	°C	Note 6-2
Operating Temperature	T _{OP}	0	+50	°C	

Note 6-1: LVDS signal

Note 6-2: Humidity : 90% RH Max. at Ta ≤ 40°C.

Maximum wet-bulb temperature is at 39°C or less at Ta > 40°C.

No condensation.

7. Electrical Characteristics
7-1) Recommended Operating Conditions:

GND = 0V , Ta = 25°C

Item	Symbol	Min.	Typ.	Max.	Unit	Remark
Supply Voltage	VDD	3.0	3.3	3.6	V	
Current Dissipation	I _{DD}	-	370	430	mA	Note 7-1
LVDS Differential input high threshold	V _{TH}	-	-	100	mV	Note 7-2
LVDS Differential input low threshold	V _{TL}	-100	-	-		
Lamp Current	I _{FL}	2.0	3.0	6.0	mA	3mA : 80 cd/m ² 6mA : 170cd/m ² Note 7-3 Note 7-5
Lamp Voltage	V _L	500	550	600	Vrms	I _{FL} =5mA Note 7-3
Lamp Initial Voltage	V _{SFL}	-	1200	-	Vrms	at Ta=25°C
		1000				at Ta=0°C
Lamp Driving Frequency	F _L	-	45	-	KHz	
Total power consumption (at I _{FL} =3mA) (at I _{FL} =6mA)		-	2.87	-	W	Note 7-4
		-	4.50	-		

Note 7-1 : To test the current dissipation of VDD, using the “color bars” testing pattern shown as below

Note 7-2 : Please refer to DS90CF364 specification by National Semiconductor Corporation. This LCD module conforms to LVDS standard.

Note 7-3 : The back-light driving waveform should be as closed to sine-wave as possible

Note 7-4 : Not including the efficiency of back-light DC/AC inverter

Note 7-5 : Lamp current is measured with current meter for high frequency as shown below

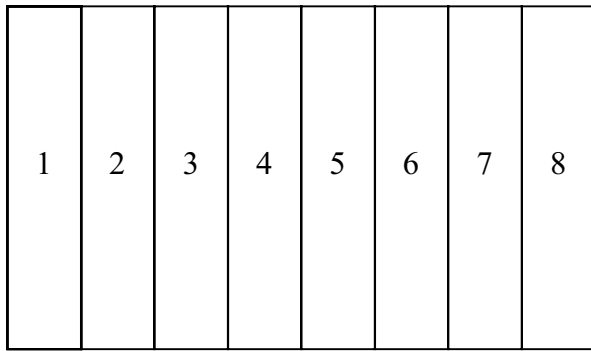

- 1. White
- 2. Yellow
- 3. Cyan
- 4. Green
- 5. Magenta
- 6. Red
- 7. Blue
- 8. Black

Idd current dissipation testing pattern

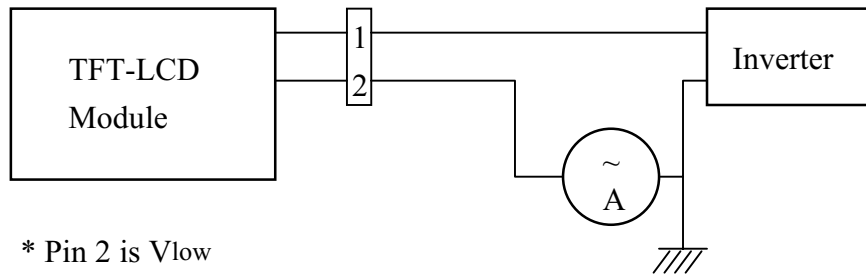

* Pin 2 is Vlow
 ** Current meter :
 Yokogawa 2016-01

Lamp current dissipation testing configuration

7-2) Input / Output signal timing chart
 (A) Vertical Timing

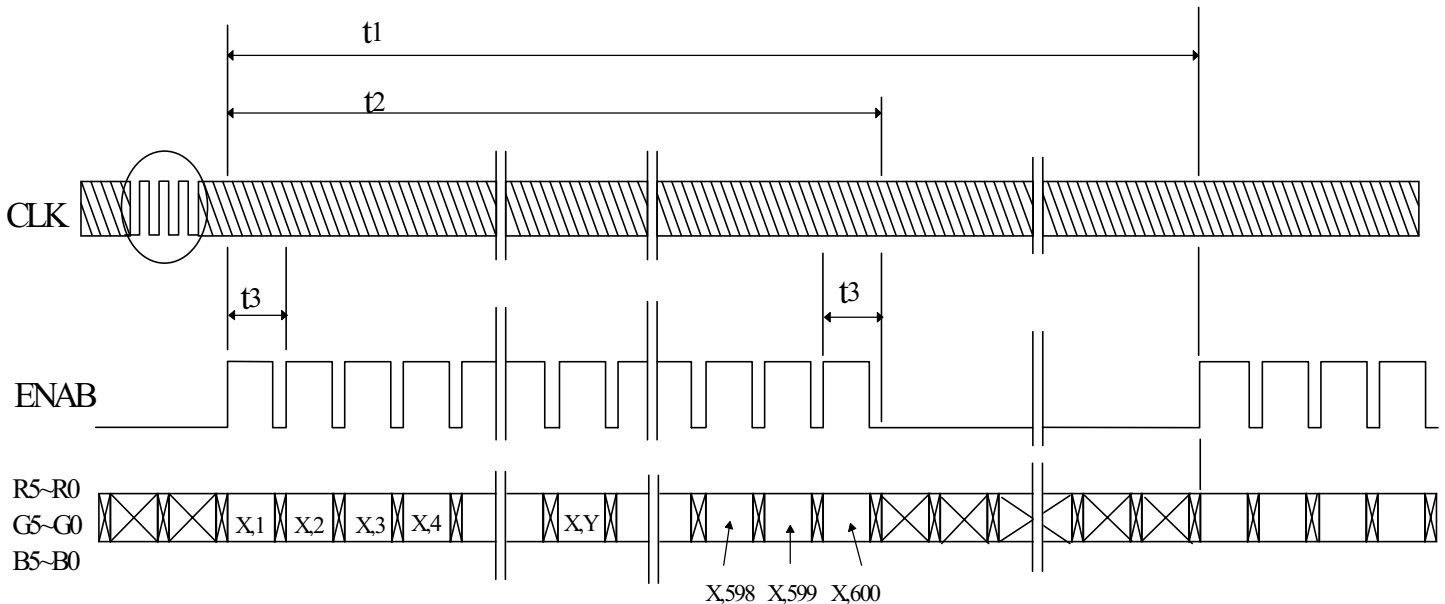

(B) Horizontal Timing

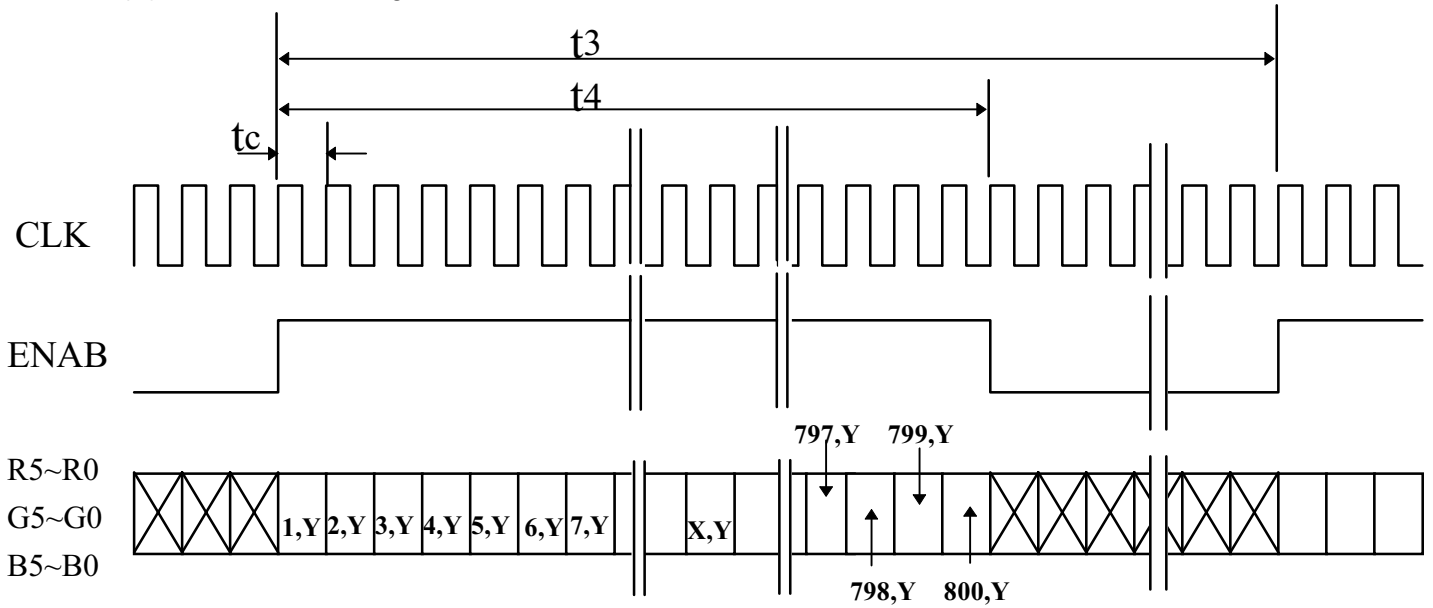

D) Timing Specifications

Item	Symbol	Min.	Typ.	Max.	Unit	Remark
Frame Cycling	t1	604 X t3	628X t3	677 X t3	-	
		-	16.58	17.86	ms	
Vertical Display Period	t2	600 X t3	600 X t3	600 X t3	-	
Horizontal Scanning Time	t3	844 X t5	1056 X t5	1064 X t5	-	
		26.3	26.4	-	μ s	
Horizontal Display Period	t4	-	800 X t5	-	-	
Clock Cycle	t5	24.0	25.0	-	ns	
Clock High Level Time	t6	9.0	-	-	ns	
Clock Low Level Time	t7	9.0	-	-	ns	
Hold time	t8	4.0	-	-	ns	
Set-up time	t9	5.0	-	-	ns	

7-3) Display Color and Gray Scale Reference

Color		Input Color Data																	
		Red						Green						Blue					
		R5	R4	R3	R2	R1	R0	G5	G4	G3	G2	G1	G0	B5	B4	B3	B2	B1	B0
Basic Colors	Black	0	0	0	0	0	0	0	0	0	0	0	0	0	0	0	0	0	0
	Red (63)	1	1	1	1	1	1	0	0	0	0	0	0	0	0	0	0	0	0
	Green (63)	0	0	0	0	0	0	1	1	1	1	1	1	0	0	0	0	0	0
	Blue (63)	0	0	0	0	0	0	0	0	0	0	0	0	1	1	1	1	1	1
	Cyan	0	0	0	0	0	0	1	1	1	1	1	1	1	1	1	1	1	1
	Magenta	1	1	1	1	1	1	0	0	0	0	0	0	1	1	1	1	1	1
	Yellow	1	1	1	1	1	1	1	1	1	1	1	1	0	0	0	0	0	0
	White	1	1	1	1	1	1	1	1	1	1	1	1	1	1	1	1	1	1
Red	Red (00)	0	0	0	0	0	0	0	0	0	0	0	0	0	0	0	0	0	0
	Red (01)	0	0	0	0	0	1	0	0	0	0	0	0	0	0	0	0	0	0
	Red (02)	0	0	0	0	1	0	0	0	0	0	0	0	0	0	0	0	0	0
	Darker																		
	↓	↓	↓	↓	↓	↓	↓	↓	↓	↓	↓	↓	↓	↓	↓	↓	↓	↓	↓
	Brighter																		
	Red (61)	1	1	1	1	0	1	0	0	0	0	0	0	0	0	0	0	0	0
	Red (62)	1	1	1	1	1	0	0	0	0	0	0	0	0	0	0	0	0	0
Red (63)	1	1	1	1	1	1	0	0	0	0	0	0	0	0	0	0	0	0	
Green	Green (00)	0	0	0	0	0	0	0	0	0	0	0	0	0	0	0	0	0	0
	Green (01)	0	0	0	0	0	0	0	0	0	0	0	1	0	0	0	0	0	0
	Green (02)	0	0	0	0	0	0	0	0	0	0	1	0	0	0	0	0	0	0
	Darker																		
	↓	↓	↓	↓	↓	↓	↓	↓	↓	↓	↓	↓	↓	↓	↓	↓	↓	↓	↓
	Brighter																		
	Green (61)	0	0	0	0	0	0	1	1	1	1	0	1	0	0	0	0	0	0
	Green (62)	0	0	0	0	0	0	1	1	1	1	1	0	0	0	0	0	0	0
Green (63)	0	0	0	0	0	0	1	1	1	1	1	1	0	0	0	0	0	0	
Blue	Blue (00)	0	0	0	0	0	0	0	0	0	0	0	0	0	0	0	0	0	0
	Blue (01)	0	0	0	0	0	0	0	0	0	0	0	0	0	0	0	0	0	1
	Blue (02)	0	0	0	0	0	0	0	0	0	0	0	0	0	0	0	0	1	0
	Darker																		
	↓	↓	↓	↓	↓	↓	↓	↓	↓	↓	↓	↓	↓	↓	↓	↓	↓	↓	↓
	Brighter																		
	Blue (61)	0	0	0	0	0	0	0	0	0	0	0	0	1	1	1	1	0	1
	Blue (62)	0	0	0	0	0	0	0	0	0	0	0	0	1	1	1	1	1	0
Blue (63)	0	0	0	0	0	0	0	0	0	0	0	0	1	1	1	1	1	1	

7-4) Pixel Arrangement

The LCD module pixel arrangement is the stripe.

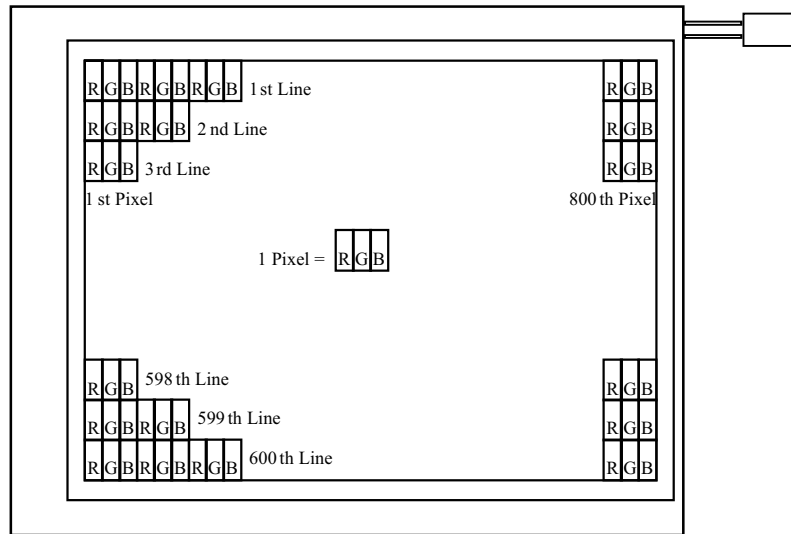

8. Optical Characteristics

8-1) Specification:

Ta = 25°C

Parameter		Symbol	Condition	MIN.	TYP.	MAX.	Unit	Remarks
Viewing Angle	Horizontal	θ	CR \geq 10	± 35	± 45	-	deg	Note 8-1
	Vertical	θ (to 12 o'clock)		10	15	-	deg	
		θ (to 6 o'clock)		25	40	-	deg	
Contrast Ratio		CR	Optimum direction	100	180	-	-	Note 8-2
Response time	Rise	Tr	$\theta = 0^\circ$	-	15	50	ms	Note 8-4
	Fall	Tf	$\phi = 0^\circ$	-	25	50	ms	
Luminance		L	$\theta = 0^\circ / \phi = 0^\circ$	70	80	-	cd/m ²	I _{FL} =3mA, Note 8-3
				-	170	-		I _{FL} =6mA, Note 8-3
Luminance Uniformity		U		55	80	-	%	Note 8-5
White Chromaticity		x		0.280	0.330	0.380	-	
		y		0.290	0.340	0.390	-	
Lamp Life Time				-	10000	-	hr	
Cross Talk Ratio		CTK		-	-	3.5	%	Note 8-6

All the optical measurement shall be executed 30 minutes after back-light being turn-on. The optical characteristics shall be measured in dark room (ambient illumination on panel surface less than 1 Lux). The measuring configuration shown as following figure.

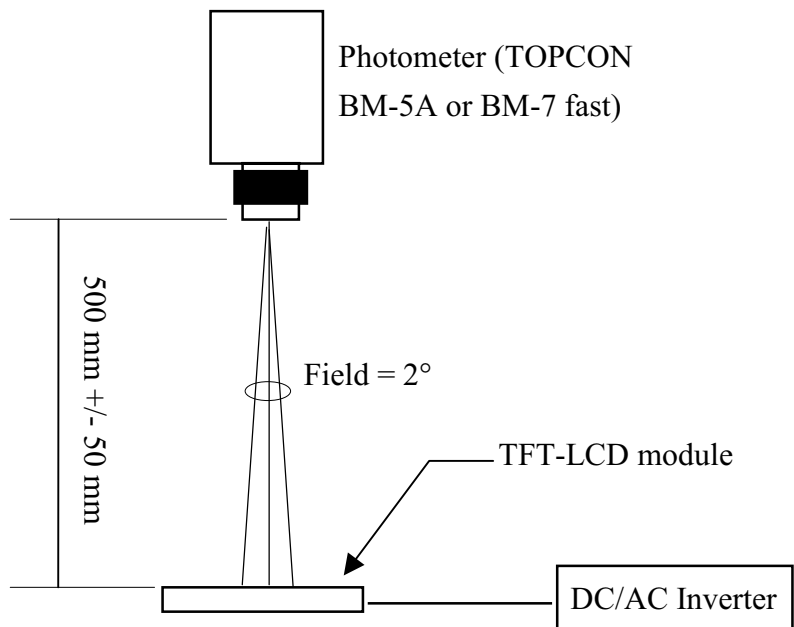

Optical characteristics measuring configuration

Note 8-1` : The definitions of viewing angles are as follows.

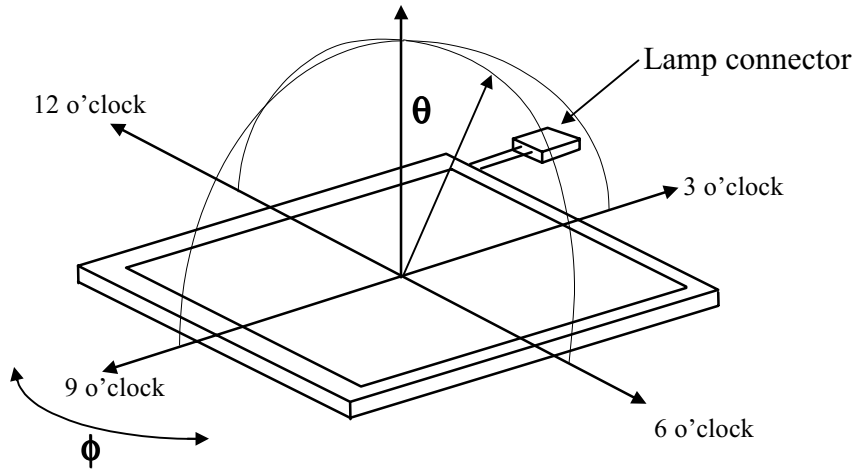

Note 8-2 : The definition of contrast ratio $CR = \frac{\text{Luminance at gray level 63}}{\text{Luminance at gray level 0}}$

Note 8-3 : Topcon BM-5A luminance meter 2° field of view is used in the testing (after 30 minutes' operation). The typical luminance value are measured at lamp current 3.0 mA. The max luminance value are measured at lamp current 6.0 mA.

Note 8-4: Definition of Response Time T_r and T_f :

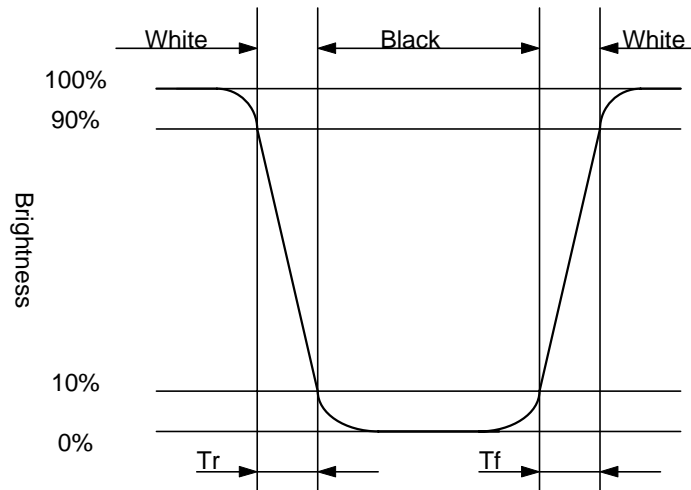

Note 8-5: The uniformity of LCD is defined as

$$U = \frac{\text{The Minimum Brightness of the 9 testing Points}}{\text{The Maximum Brightness of the 9 testing Points}}$$

Luminance meter : BM-5A or BM-7 fast(TOPCON)

Measurement distance : 500 mm +/- 50 mm

Ambient illumination : < 1 Lux

Measuring direction : Perpendicular to the surface of module

The test pattern is white (Gray Level 63).

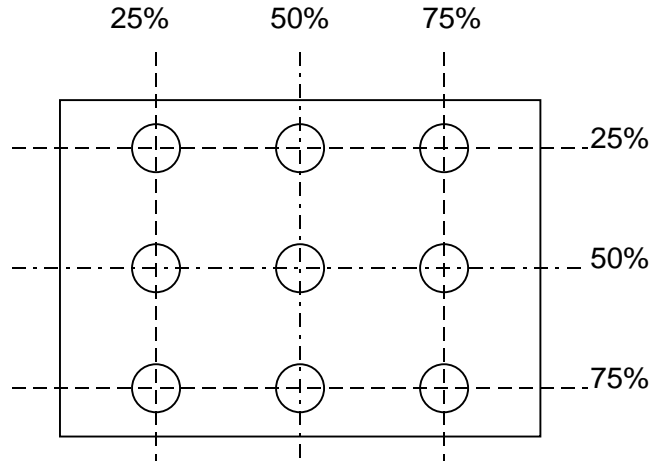

Note 8-6: Cross Talk (CTK) = $\frac{|YA-YB|}{YA} \times 100\%$

YA: Brightness of Pattern A

YB: Brightness of Pattern B

Luminance meter : BM 5A (TOPCON)

Measurement distance : 500 mm +/- 50 mm

Ambient illumination : < 1 Lux

Measuring direction : Perpendicular to the surface of module

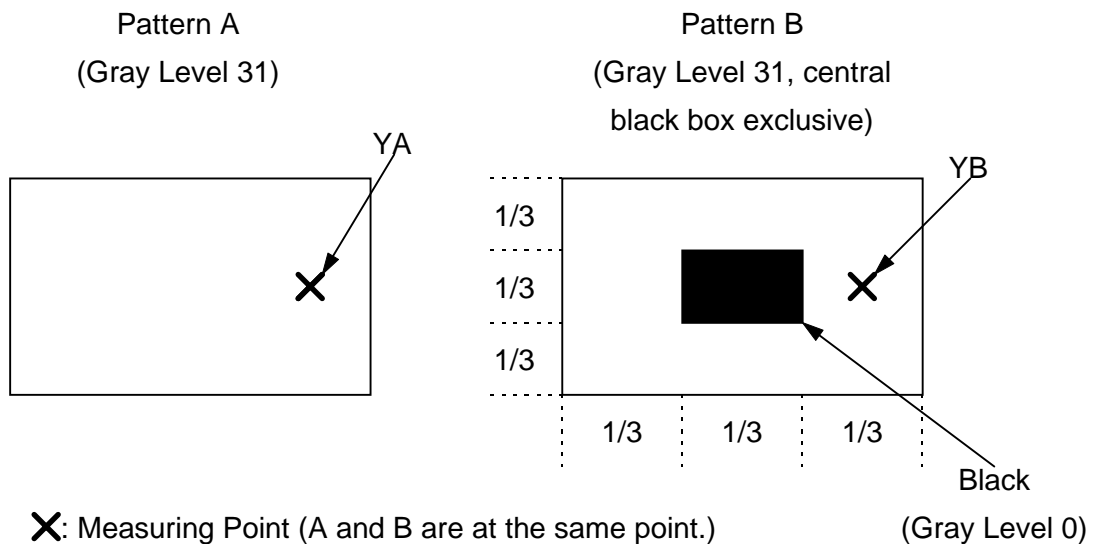

9. Reliability Test

No	Test Item	Test Condition	Remark
1	High Temperature Storage Test	Ta = +60°C, 240 hrs	
2	Low Temperature Storage Test	Ta = -20°C, 240 hrs	
3	High Temperature Operation Test	Ta = +50°C, 240 hrs	
4	Low Temperature Operation Test	Ta = 0°C, 240 hrs	
5	High Temperature & High Humidity Operation Test	Ta = +50°C, 80%RH, 240 hrs (NoCondensation)	
6	Thermal Cycling Test (non-operating)	0°C ←→ +25°C ←→ +60°C, 50 Cycles 1Hr 0.5Hr 1Hr	
7	Vibration Test (non-operating)	Frequency : 10 ~ 57 Hz, Amplitude : 0.15 mm 58~500Hz, 1G Sweep time: 11 min Test Period: 3 hrs (1 hr for each direction of X, Y, Z)	
8	Shock Test (non-operating)	80G, 6ms, X,Y, Z 1 times for each direction	

Ta: ambient temperature

[Judgement Criteria]

Under the display quality test conditions with normal operation state , there should be no change which may affect practical display function.

10. Block Diagram

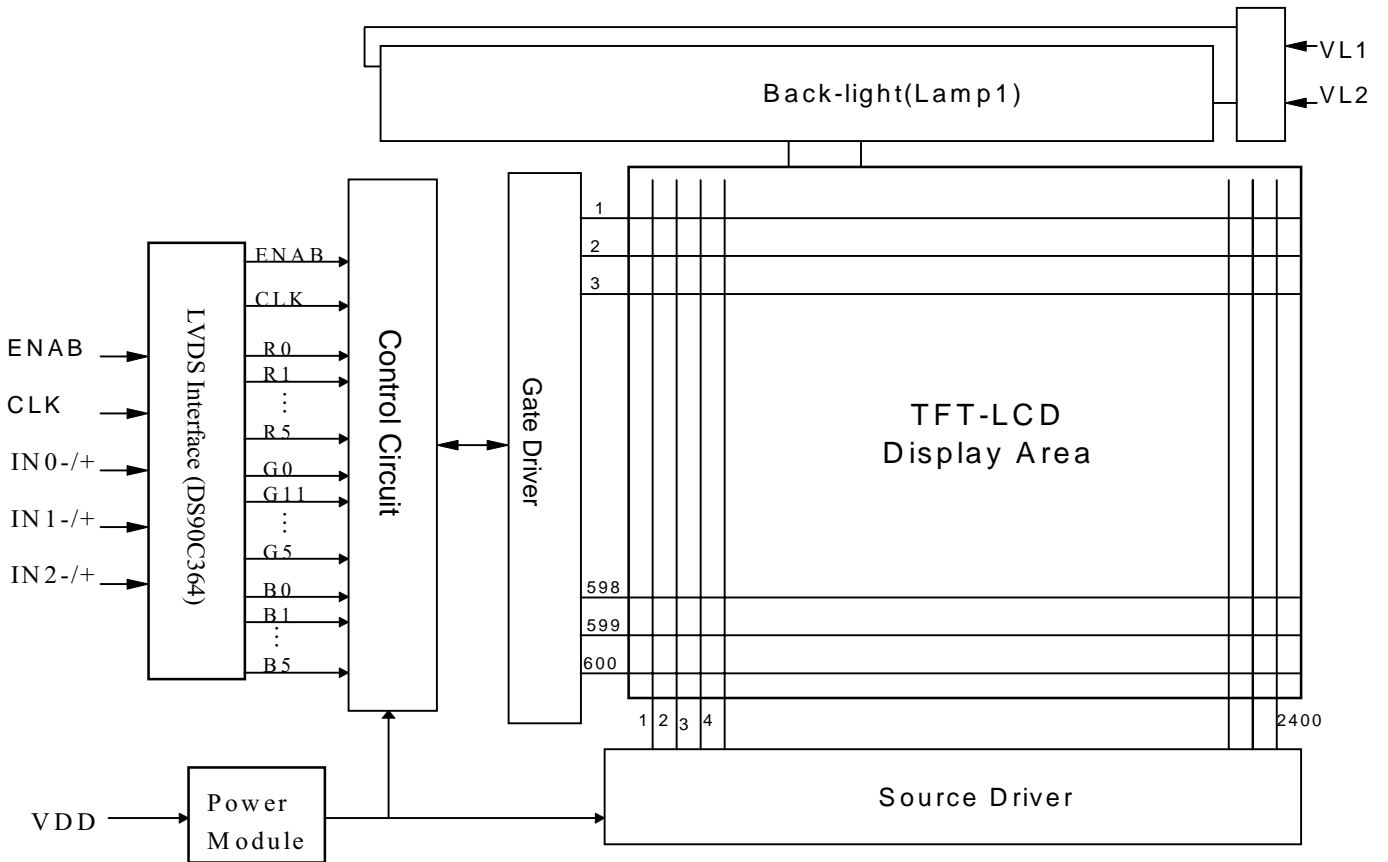

Revision History

Rev.	Issued Date	Revised Content
0.1	March 19, 1999	New
0.2	April 17, 1999	<p>Page 3, Application : modify the description. Page 3, Feature : modify the description. Page 3, Mechanical Spec. : adding two items, "Surface treatment" and "Display mode". Page 6 : modify LVDS Interface Block Diagram Page 7 : adding "Note 7-3 : The back-light driving waveform should be as closed to sine-wave as possible " Page 7 : adding "Note 7-5 : Lamp current is measured with current meter for high frequency " Page 13, Optical characteristics : adding the optical characteristics measuring condition and configuration figure. page 13, Note 8-5 , adding the "measuring method and instrument" of display uniformity as follow : Luminance meter : BM-5A or BM-7 fast(TOPCON) Measurement distance : 500 mm +/- 50 mm Ambient illumination : < 1 Lux Measuring direction : Perpendicular to the surface of module</p>
0.3	June 24, 1999	<p>Page 3, 3. Mechanical spec. : The module weight change from 300g (typ.) to 315g (typ.) The module outline dimension change to : 238.6 (w) × 171.0(H) × 6.0 max (D) Page 4, 4. Mechanical drawing of TFT LCD module : new version Page 6, 5-2) Lamp connector type, change from "BHR-03VS-1" to "BHR-02VS-1" Pin 2 : Input voltage (Low), Pin 3 was not exist. Page 8, Re-drawing the "Lamp current dissipation testing configuration". The lamp connector change from 3 pin to 2 pin. Page 8, Re-drawing the "Vertical timing chart" Page 9, Re-drawing the "Horizontal timing chart" Page 9, Delete "Recommended input clock timing chart to transmitter (DS90C*363) " Page 9, D) Timing spec. : "Frame Cycling (typ. value)": change from 17.78 ms to 16.58 ms</p>
0.4	Sep. 10, 1999	3. Mechanical spec. : The module weight change from 315g (typ.) to 300g (typ.)
0.5	Feb. 10, 2000	<p>8. Optical spec.: The typical brightness change from 70 nits to 95 nits. Min. brightness change from 65 nits to 75 nits 9 Reliability test:: item(7), vibration test condition, amplitude change from 1.5mm to 0.2mm</p>
1.0	April, 7, 2000	<p>8. Optical spec.: The typical brightness change from 95 nits to 80 nits. Min. brightness change from 75 nits to 70 nits Change contrast ratio from 200 (typ.) to 180 (typ.) Change white color coordinate from (0.320, 0.330) to (0.330, 0.340) 3.Mechanical spec. Change module weight from 300g to 312g. 4.Mechanical Drawing: Replaced by a new drawing because a little change of mounting hole position. 7. Electrical spec. Change power consumption from 2.5W(4.3W) to 2.87W (4.5W)</p>