

TEMPERATURE CONTROLLER IC

FEATURES

- Internal Temperature Sensor, Voltage Reference and Comparator
- Temperature Threshold and Hysteresis Set by Only Two External Resistors
- Output Logic: High to Low with Increasing Temp.
- Active High On/Off Control
- 2.7 to 6.0 V Supply Range
- Miniature Package (SOT-23L-6)
- Minimum External Parts Count
- Low Power Consumption
- Very Wide Temperature Range

DESCRIPTION

The TK11051 is an accurate temperature controller IC for use over the -30 to +105 °C temperature range. The TK11051 monolithic bipolar integrated circuit contains a temperature sensor, stable voltage reference and a comparator, making the device very useful as an on/off temperature controller. Two external resistors easily set the sensing temperature threshold and hysteresis. Its wide operating voltage range of 2.7 to 6.0 V makes this IC suitable for a number of applications requiring accurate temperature control. The device is in the "on" state when the control pin is pulled to a logic high level.

The TK11051 is available in a miniature SOT-23L-6 surface mount package.

APPLICATIONS

- Home and Industrial Thermostats
- Home Appliance Temperature Control
- Notebook Computer Temperature Monitor
- Pentium Processor Temperature Monitor
- Power Supply Overtemperature Protection
- Copy Machine Overtemperature Protection
- System Overtemperature Protection

ORDERING INFORMATION

TK11051MTL

└── Tape/Reel Code

TAPE/REEL CODE
TL: Tape Left

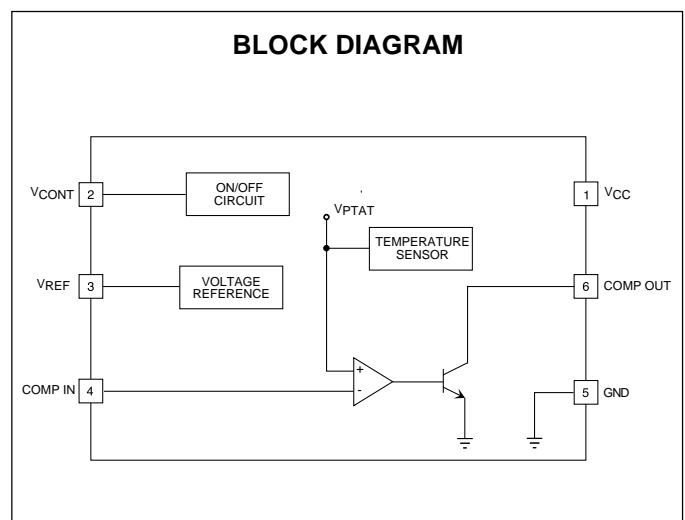
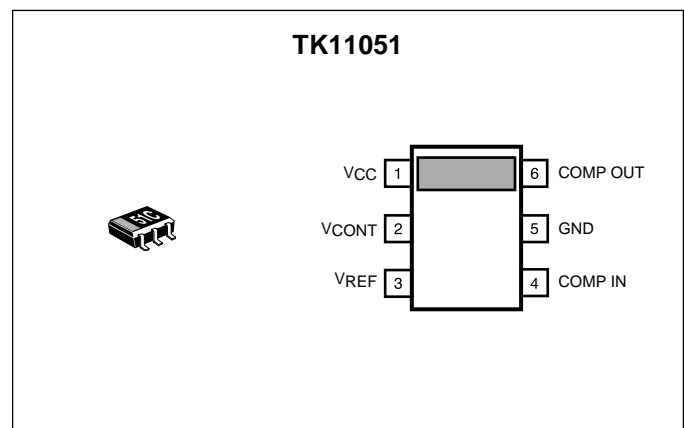

TK11051

ABSOLUTE MAXIMUM RATINGS

Supply Voltage	12 V	Operating Voltage Range	2.7 to 6 V
Power Dissipation (Note 1)	200 mW	Junction Temperature	150 °C
Storage Temperature Range	-55 to +150 °C	Lead Soldering Temperature (10 s)	235 °C
Operating Temperature Range	-30 to +105 °C		

TK11050 ELECTRICAL CHARACTERISTICS

Test conditions: $T_A = 25\text{ °C}$, $V_{CC} = 3.0\text{ V}$, $V_{CONT} = 2.4\text{ V}$, $I_{OUT} = 40\text{ }\mu\text{A}$, $R_3 = 100\text{ k}\Omega$, unless otherwise specified.

SYMBOL	PARAMETER	TEST CONDITIONS	MIN	TYP	MAX	UNITS
I_{CC}	Quiescent Current	Comparator Output LOW		250	350	μA
		Comparator Output HIGH		210	350	μA
I_{STBY}	Standby Current	$V_{CONT} \leq 0.6\text{ V}$			1	μA
V_{PTAT}	Temperature Sensor Voltage (Note 4)	$T_A = 25\text{ °C}$		1.192		V
		$T_A = 85\text{ °C}$		1.432		V
		$T_A = -30\text{ °C}$		0.972		V
T_C	Temperature Coefficient	$T_A = 0\text{ to }85\text{ °C}$		4.0		$\text{mV}/\text{°C}$
T_{ERR}	Temperature Error	$T_A = 0\text{ to }85\text{ °C}$, (Note 2)	-4.0	0	4.0	°C
C_{LH}	Comparator Output HIGH	(Note 3)	2.8			V
C_{LL}	Comparator Output LOW	$R_3 \geq 10\text{ k}\Omega$, (Note 3)			0.3	V
I_{IB}	Input Bias Current	Comparator IN $> V_{PTAT}$		0.1	0.3	μA
I_{SH}	Hysteresis Set Current	Comparator IN $< V_{PTAT}$	0.9	1.25	1.6	μA
I_{OUT}	Output Sink Current	$C_{LL} \leq 0.3\text{ V}$		30	300	μA
V_{ref} TERMINAL CHARACTERISTICS						
V_{ref}	Reference Voltage	$T_A = 25\text{ °C}$		1.6		V
I_{ref}	Reference Output Current	$R_1 + R_2 = 40\text{ k}\Omega$		40	500	μA
Line Reg	Line Regulation	$V_{CC} = 3\text{ to }6\text{ V}$		2	8	mV
Load Reg	Load Regulation	$I_{OUT} = 0\text{ to }500\text{ }\mu\text{A}$		1	8	mV
CONTROL TERMINAL SPECIFICATIONS						
I_{CONT}	Control Current		1	3.5	6	μA
$V_{CONT(ON)}$	Control Voltage (ON)	Output ON	1.8		V_{CC}	V
$V_{CONT(OFF)}$	Control Voltage (OFF)	Output OFF	GND		0.6	V

Note 1: Power dissipation is 200 mW when in Free Air. Derate at 1.6 mW/°C for operation above 25 °C.

Note 2: The resistance values of R_1 and R_2 can be calculated as follows: $R_1 = V_{ref} \times T_{SH} / (T_{SET} \times I_{SH} - (T_{SET} - T_{SH}) \times I_{IB})$, $R_2 = T_{SET} \times T_C \times R_1 / (V_{ref} - R_1 \times I_{IB} - T_{SET} \times T_C)$. I_{IB} is 0.1 μA and I_{SH} is 1.25 μA .

Note 3: When $V_{PTAT} < \text{COMP IN}$, COMP OUT $> 2.8\text{ V}$ (High Level). When $V_{PTAT} > \text{COMP IN}$, COMP OUT $< 0.3\text{ V}$ (Low Level).

Note 4: V_{PTAT} does not have an output pin.

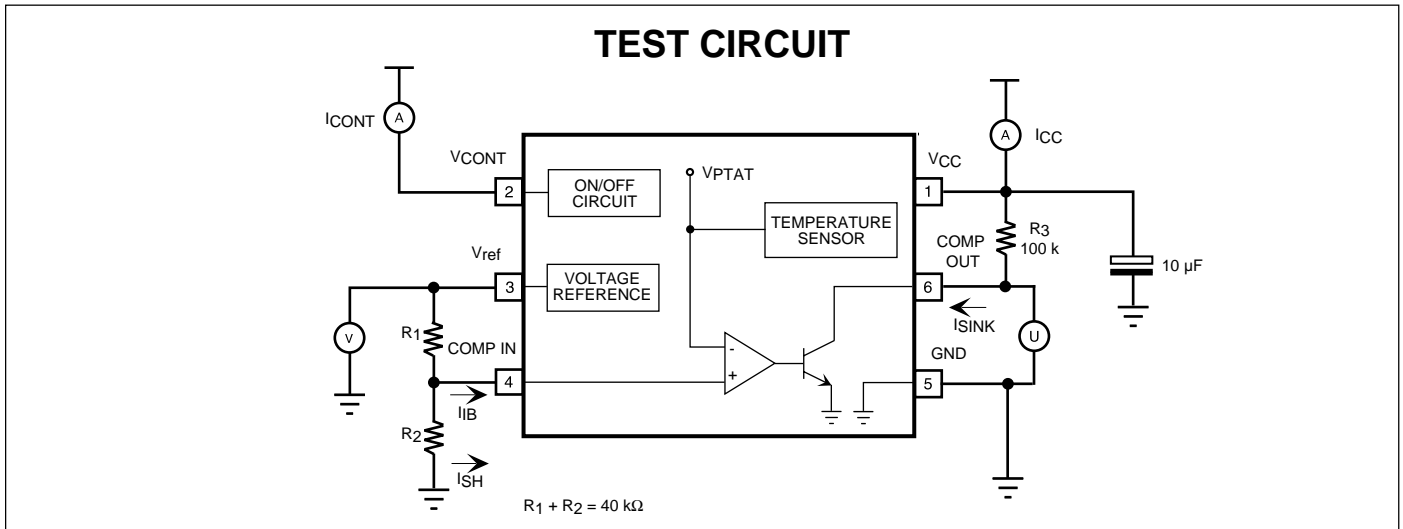

TYPICAL PERFORMANCE CHARACTERISTICS

$T_A = 25 \text{ }^\circ\text{C}$, $V_{CC} = 3 \text{ V}$, $V_{CONT} = 2.4 \text{ V}$, $I_{OUT} = 40 \text{ }\mu\text{A}$, unless otherwise specified.

REFERENCE VOLTAGE vs. TEMPERATURE

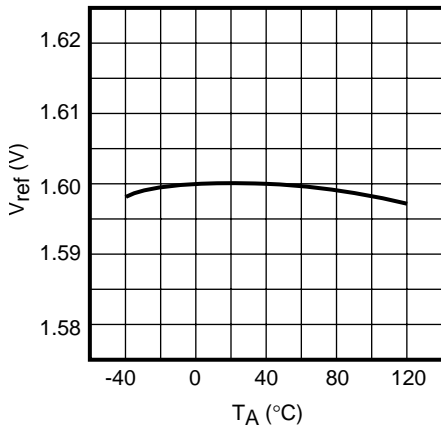

REFERENCE VOLTAGE vs. TEMPERATURE

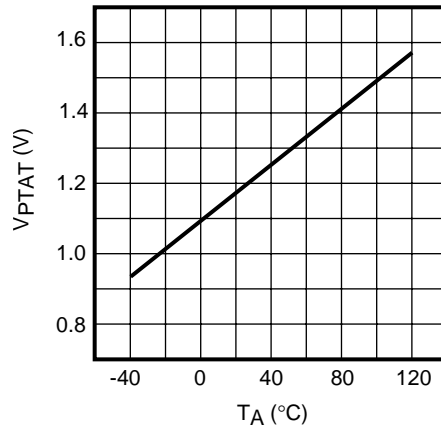

LINE REGULATION

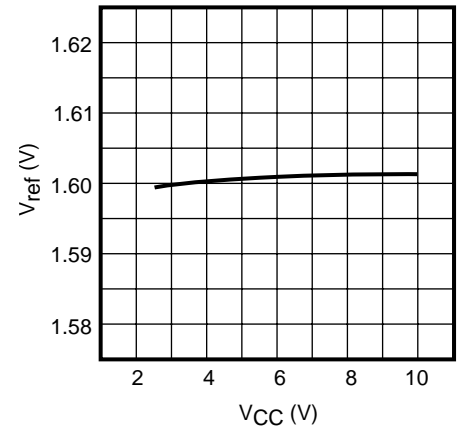

LOAD REGULATION

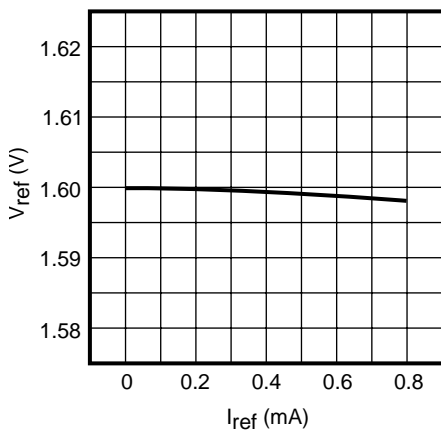

CONTROL CURRENT vs. TEMPERATURE

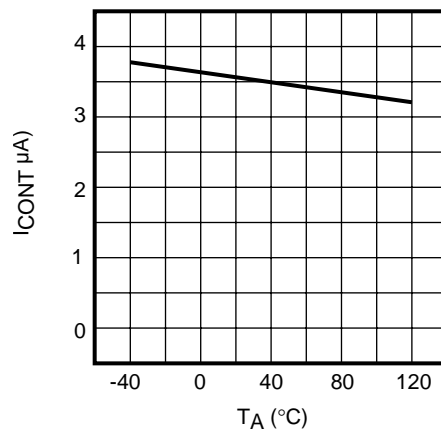

CONTROL CURRENT vs. CONTROL VOLTAGE

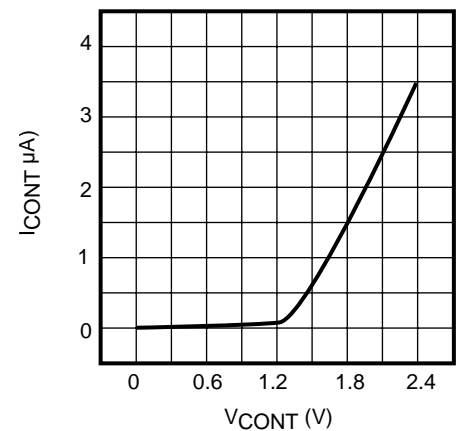

TYPICAL PERFORMANCE CHARACTERISTICS (CONT.)

$T_A = 25\text{ }^\circ\text{C}$, $V_{CC} = 3\text{ V}$, $V_{CONT} = 2.4\text{ V}$, $I_{OUT} = 40\text{ }\mu\text{A}$, unless otherwise specified.

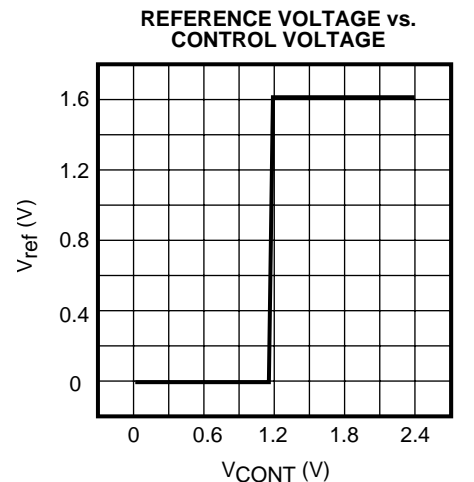
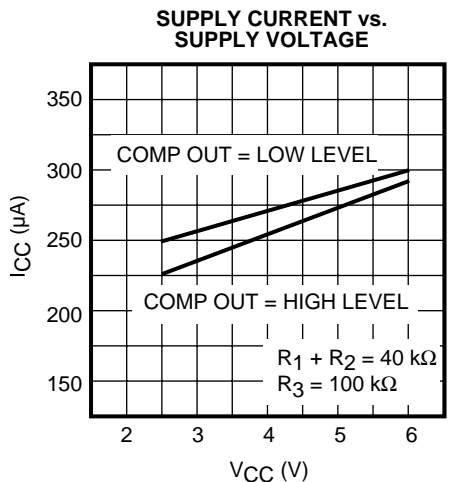
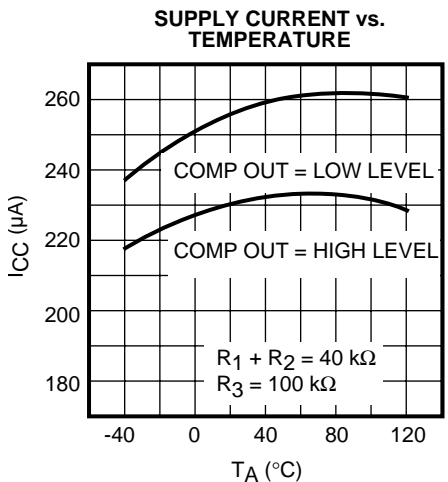
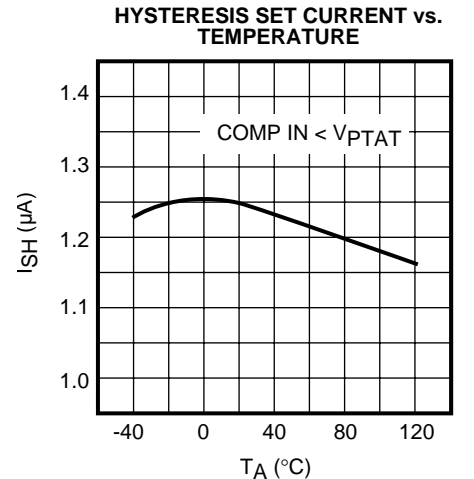
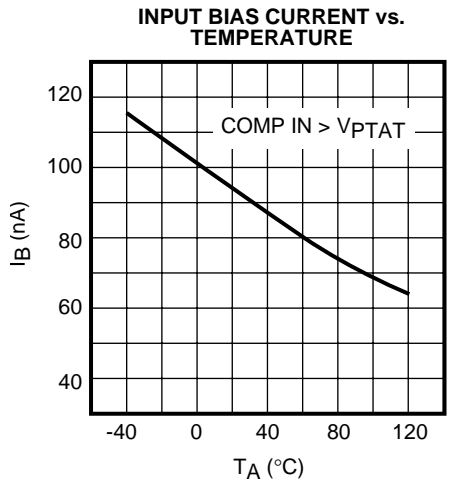
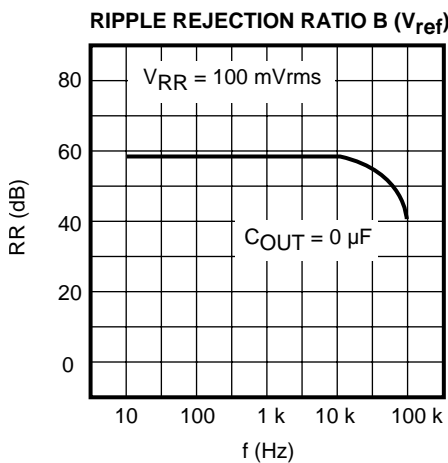
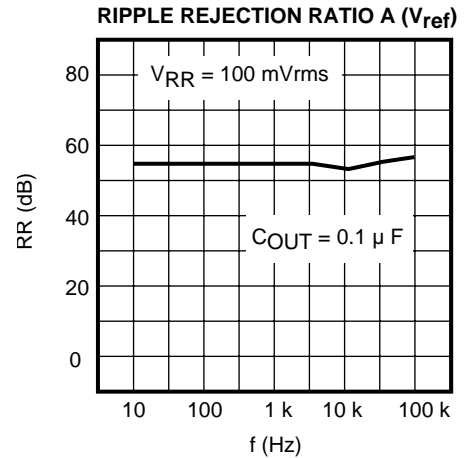
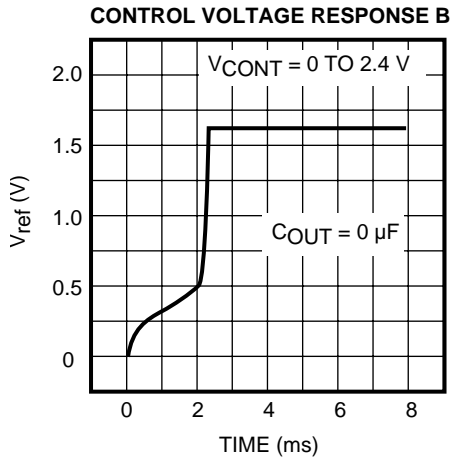
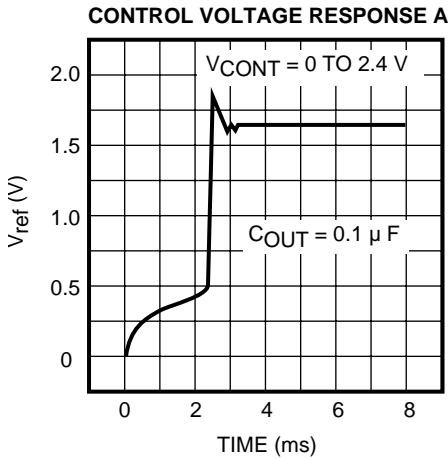

TYPICAL PERFORMANCE CHARACTERISTICS (CONT.)

$T_A = 25\text{ }^\circ\text{C}$, $V_{CC} = 3\text{ V}$, $V_{CONT} = 2.4\text{ V}$, $I_{OUT} = 40\text{ }\mu\text{A}$, unless otherwise specified.

SUPPLY CURRENT vs. CONTROL VOLTAGE

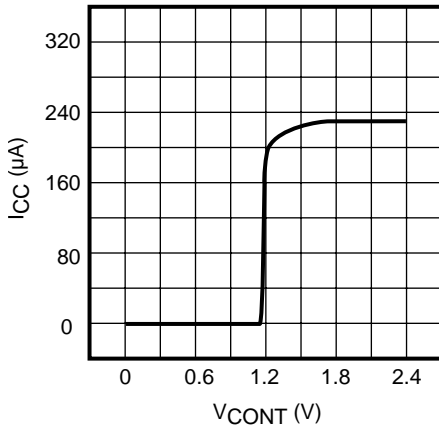

COMPARATOR OUTPUT (LOW LEVEL) vs. OUTPUT SINK CURRENT

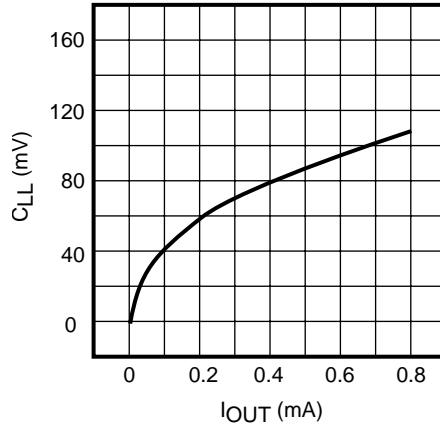

COMPARATOR OUTPUT vs. TEMPERATURE

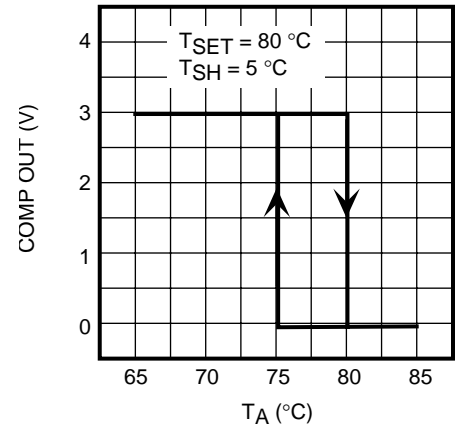

CONTROL VOLTAGE RESPONSE

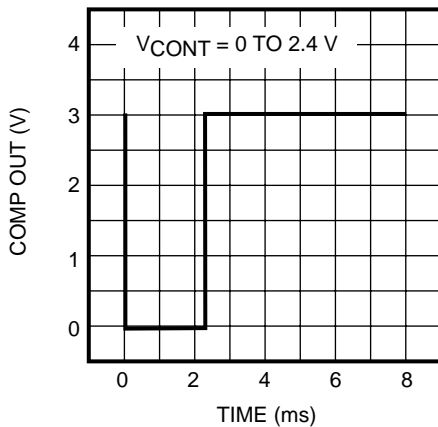

COMPARATOR INPUT RESPONSE

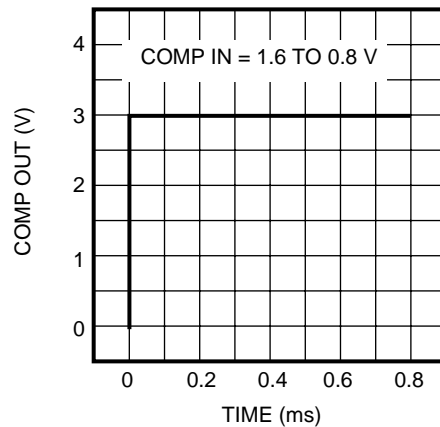

TEMPERATURE RESPONSE A

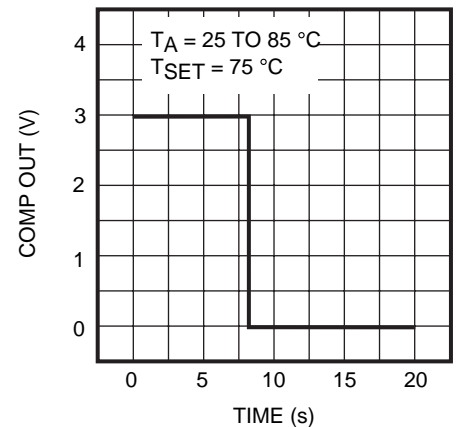

TEMPERATURE RESPONSE B

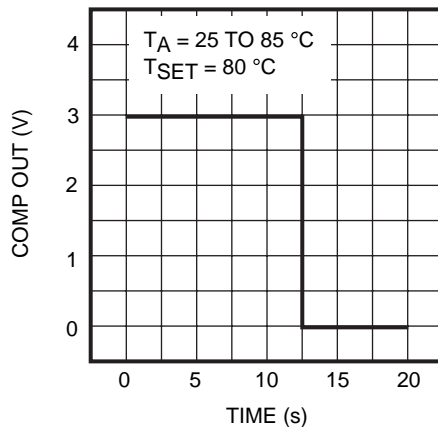

TEMPERATURE RESPONSE C

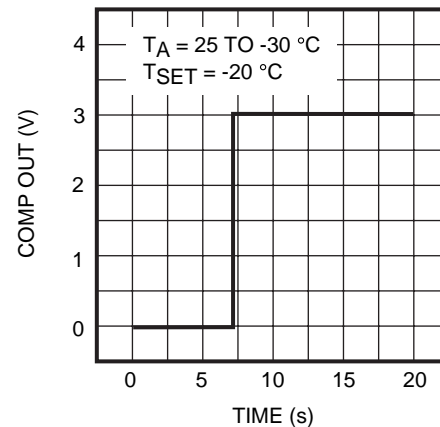

TEMPERATURE RESPONSE D

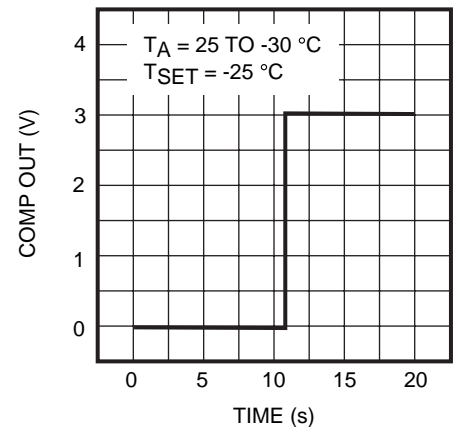

APPLICATION HINTS

EXTERNAL RESISTORS R_1 AND R_2

The temperature set point (T_{SET}) and hysteresis (T_{SH}) of the TK11051 are easily set by two external resistors R_1 and R_2 . See Figure 1 for clarification of T_{SET} and T_{SH} .

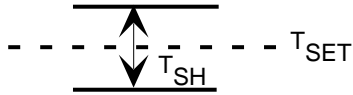

FIGURE 1

The set voltage (V_{SET}) of the comparator at the set temperature (T_{SET}) is calculated as follows:

$$V_{SET} = T_{SET} \times T_C \quad (1)$$

where T_{SET} is an absolute temperature ($^{\circ}\text{K}$).
That is, $T_{SET} (^{\circ}\text{K}) = ^{\circ}\text{C} + 273$
and $T_C = 4 \text{ mV}/^{\circ}\text{C}$.

1. For Set Temperatures $\geq 25^{\circ}\text{C}$

$$V_{SET} = \frac{R_2 \times V_{ref}}{R_1 + R_2} - \frac{R_1 \times R_2 \times I_{IB}}{R_1 + R_2} = \frac{R_2}{R_1 + R_2} \times (V_{ref} - R_1 \times I_{IB}) \quad (2)$$

where $V_{ref} = 1.6 \text{ V}$
 $I_{IB} = 0.1 \mu\text{A}$

The temperature coefficient (T_C) is calculated by Equations 1 and 2, resulting in:

$$T_C = \frac{R_2}{R_1 + R_2} \times \frac{V_{ref} - R_1 \times I_{IB}}{T_{SET}} \quad (3)$$

From Equation 3, R_2 is calculated as follows:

$$R_2 = \frac{T_{SET} \times T_C \times R_1}{V_{ref} - R_1 \times I_{IB} - T_{SET} \times T_C} \quad (4)$$

The hysteresis voltage (V_{SH}) of the comparator can be calculated as follows:

$$V_{SH} = \left(\frac{R_1 \times R_2}{R_1 + R_2} \right) \times (I_{SH} - I_{IB}) \quad (5)$$

where $I_{SH} = 1.25 \mu\text{A}$

The hysteresis represented as temperature is:

$$T_{SH} = \left(\frac{R_1 \times R_2}{R_1 + R_2} \right) \times \frac{(I_{SH} - I_{IB})}{T_C} \quad (6)$$

Solving for temperature coefficient (T_C):

$$T_C = \left(\frac{R_1 \times R_2}{R_1 + R_2} \right) \times \frac{(I_{SH} - I_{IB})}{T_{SH}} \quad (7)$$

Solving for R_1 from Equations 3 and 7:

$$R_1 = \frac{V_{ref} \times T_{SH}}{T_{SET} \times I_{SH} - (T_{SET} - T_{SH}) \times I_{IB}} \quad (8)$$

R_2 can now be calculated by substituting R_1 into Equation 4:

Example:

R_1 and R_2 when set temperature is 80°C ($T_{SET} = 353^{\circ}\text{K}$) and temperature hysteresis (T_{SH}) is 5°C .

$$R_1 = \frac{1.6 \times 5}{353 \times 1.25 \mu - (353 - 5) \times 0.1 \mu}$$

$$R_1 = 19.68 \text{ k} = 20 \text{ k}\Omega$$

$$R_2 = \frac{353 \times 4 \text{ m} \times 19.68 \text{ k}}{1.6 - 19.68 \text{ k} \times 0.1 \mu - 353 \times 4 \text{ m}}$$

$$R_2 = 149.39 \text{ k} = 150 \text{ k}\Omega$$

APPLICATION HINTS (CONT.)

2. For Set Temperatures < 25 °C

$$R_1 = \frac{V_{\text{ref}} \times T_{\text{SH}}}{(T_{\text{SET}} + T_{\text{SH}}) \times I_{\text{SH}} - T_{\text{SET}} \times I_{\text{IB}}}$$

(9)

$$R_2 = \frac{T_{\text{SET}} \times T_{\text{C}} \times R_1}{V_{\text{ref}} - R_1 \times I_{\text{SH}} - T_{\text{SET}} \times T_{\text{C}}}$$

(10)

Example:

R_1 and R_2 when set temperature is -25 °C ($T_{\text{SET}} = 248$ °K) and temperature hysteresis (T_{SH}) is 5 °C.

$$R_1 = \frac{1.6 \times 5}{(248 + 5) \times 1.25 \mu - 248 \times 0.1 \mu}$$

$$R_1 = 27.45 \text{ k} = 27 \text{ k}\Omega$$

$$R_2 = \frac{248 \times 4 \text{ m} \times 27.45 \text{ k}}{1.6 - 27.45 \text{ k} \times 1.25 \mu - 248 \times 4 \text{ m}}$$

$$R_2 = 47.47 \text{ k} = 47 \text{ k}\Omega$$

PACKAGE POWER DISSIPATION (P_D)

The power dissipation rating of 200 mW represents the amount of power the device can dissipate without damage to the IC. Power dissipation should be kept to a minimum to reduce temperature errors due to self-heating.

PACKAGE OUTLINE

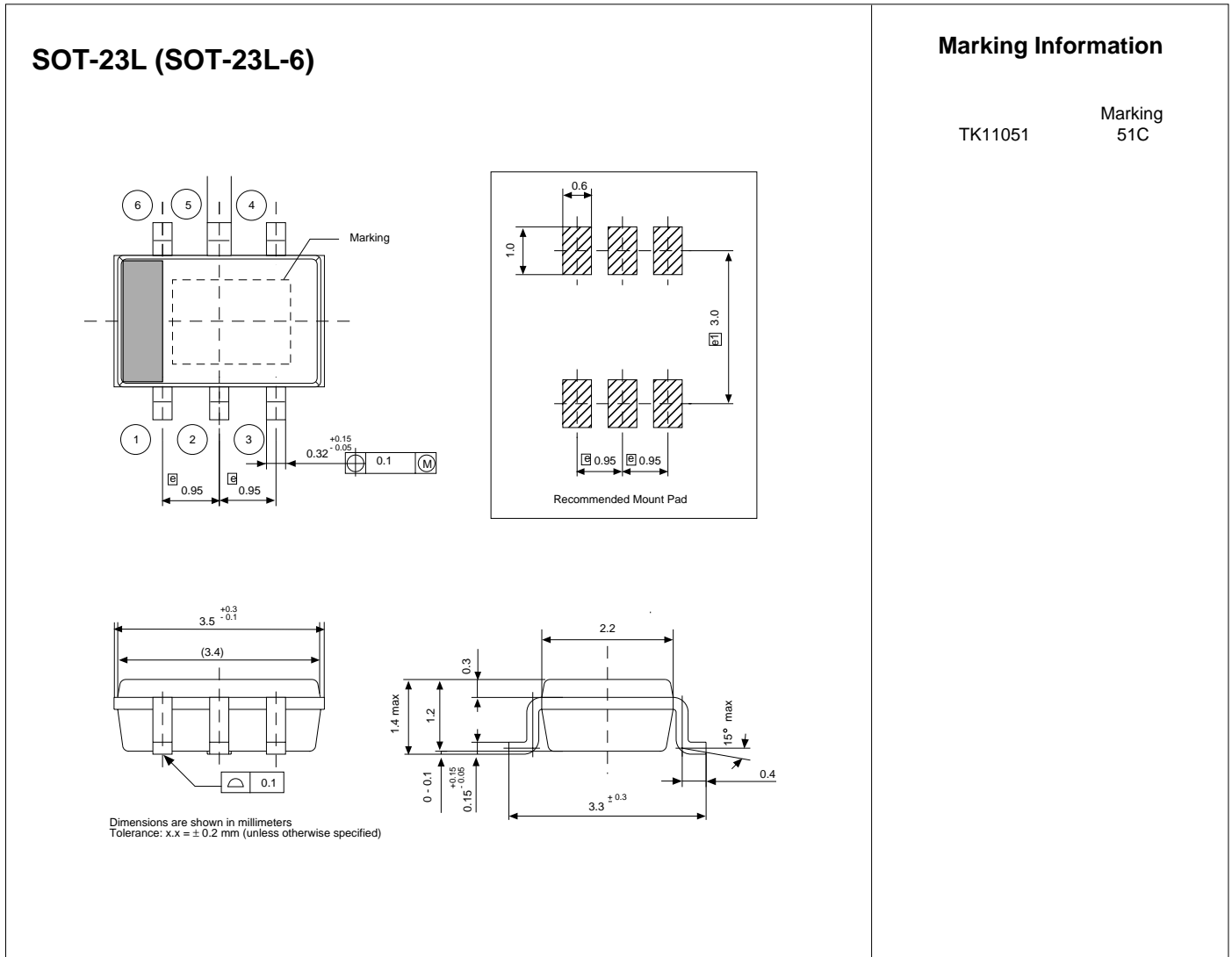

Toko America, Inc. Headquarters
1250 Feehanville Drive, Mount Prospect, Illinois 60056
Tel: (847) 297-0070 Fax: (847) 699-7864

TOKO AMERICA REGIONAL OFFICES

Midwest Regional Office
Toko America, Inc.
1250 Feehanville Drive
Mount Prospect, IL 60056
Tel: (847) 297-0070
Fax: (847) 699-7864

Western Regional Office
Toko America, Inc.
2480 North First Street, Suite 260
San Jose, CA 95131
Tel: (408) 432-8281
Fax: (408) 943-9790

Eastern Regional Office
Toko America, Inc.
107 Mill Plain Road
Danbury, CT 06811
Tel: (203) 748-6871
Fax: (203) 797-1223

Semiconductor Technical Support
Toko Design Center
4755 Forge Road
Colorado Springs, CO 80907
Tel: (719) 528-2200
Fax: (719) 528-2375

Visit our Internet site at <http://www.tokoam.com>

The information furnished by TOKO, Inc. is believed to be accurate and reliable. However, TOKO reserves the right to make changes or improvements in the design, specification or manufacture of its products without further notice. TOKO does not assume any liability arising from the application or use of any product or circuit described herein, nor for any infringements of patents or other rights of third parties which may result from the use of its products. No license is granted by implication or otherwise under any patent or patent rights of TOKO, Inc.