

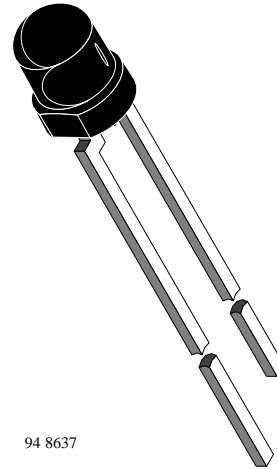
Silicon NPN Phototransistor

Description

TEFT4300 is a high speed and high sensitive silicon NPN epitaxial planar phototransistor in a standard T-1 (\varnothing 3 mm) plastic package.

The epoxy package itself is an IR filter, spectrally matched to GaAs IR emitters with $\lambda_p \geq 900\text{nm}$.

The plastic lens provides a wide viewing angle of $\pm 30^\circ$.



94 8637

Features

- High radiant sensitivity
- Fast response times
- T1 (\varnothing 3 mm) plastic package with IR filter
- Additional polarity sign
- Wide viewing angle $\varphi = \pm 30^\circ$
- Suitable for near infrared radiation
- Matches with TSUS4300 GaAs infrared emitter

Applications

Optical switches
Counters and sorters
Interrupters
Tape and card readers
Encoders
Position sensors

Absolute Maximum Ratings

$T_{\text{amb}} = 25^\circ\text{C}$

Parameter	Test Conditions	Symbol	Value	Unit
Collector Emitter Voltage		V_{CEO}	70	V
Emitter Collector Voltage		V_{ECO}	5	V
Collector Current		I_{C}	50	mA
Peak Collector Current	$t_p/T = 0.5, t_p \leq 10 \text{ ms}$	I_{CM}	100	mA
Total Power Dissipation	$T_{\text{amb}} \leq 55^\circ\text{C}$	P_{tot}	100	mW
Junction Temperature		T_{j}	100	$^\circ\text{C}$
Storage Temperature Range		T_{stg}	-55...+100	$^\circ\text{C}$
Soldering Temperature	$t \leq 3 \text{ s}, 2 \text{ mm from case}$	T_{sd}	260	$^\circ\text{C}$
Thermal Resistance Junction/Ambient		R_{thJA}	450	K/W

Basic Characteristics

 $T_{amb} = 25^{\circ}\text{C}$

Parameter	Test Conditions	Symbol	Min	Typ	Max	Unit
Collector Emitter Breakdown Voltage	$I_C = 1\text{ mA}$	$V_{(BR)CE}$ V_O	70			V
Collector Dark Current	$V_{CE} = 20\text{ V}, E = 0$	I_{CEO}		1	200	nA
Collector Emitter Capacitance	$V_{CE} = 5\text{ V}, f = 1\text{ MHz}, E=0$	C_{CEO}		3		pF
Collector Light Current	$E_e = 1\text{ mW/cm}^2,$ $\lambda = 950\text{ nm}, V_{CE} = 5\text{ V}$	I_{ca}	0.8	3.2		mA
Angle of Half Sensitivity		ϕ		± 30		deg
Wavelength of Peak Sensitivity		λ_p		925		nm
Range of Spectral Bandwidth		$\lambda_{0.5}$		875...1000		nm
Collector Emitter Saturation Voltage	$E_e = 1\text{ mW/cm}^2,$ $\lambda = 950\text{ nm}, I_C = 0.1\text{ mA}$	V_{CEsat}			0.3	V
Turn-On Time	$V_S = 5\text{ V}, I_C = 5\text{ mA},$ $R_L = 100\ \Omega$	t_{on}		2.0		μs
Turn-Off Time	$V_S = 5\text{ V}, I_C = 5\text{ mA},$ $R_L = 100\ \Omega$	t_{off}		2.3		μs
Cut-Off Frequency	$V_S = 5\text{ V}, I_C = 5\text{ mA},$ $R_L = 100\ \Omega$	f_c		180		kHz

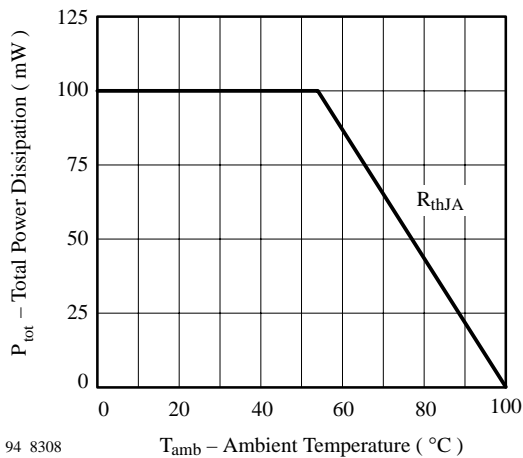
Typical Characteristics ($T_{amb} = 25^{\circ}\text{C}$ unless otherwise specified)

Figure 1. Total Power Dissipation vs. Ambient Temperature

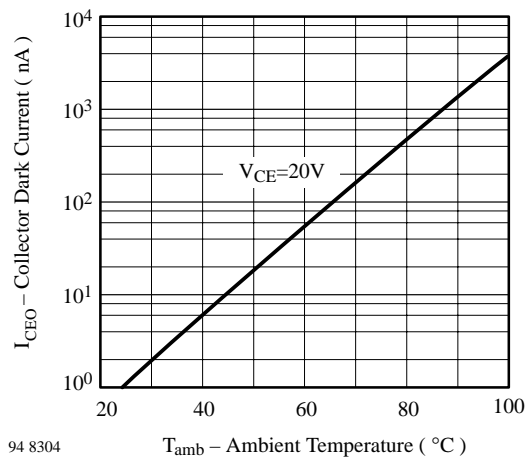
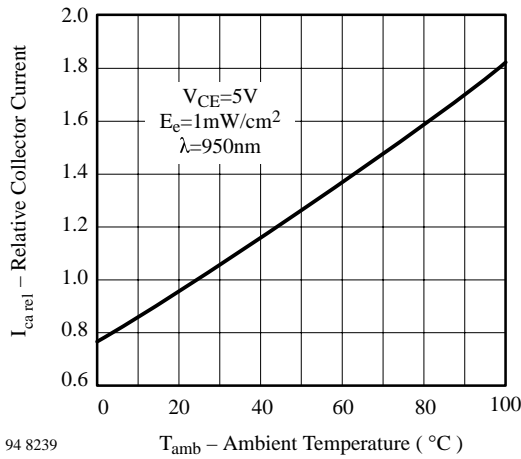
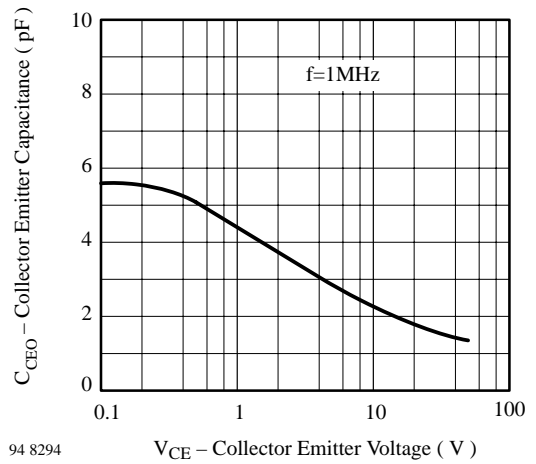


Figure 2. Collector Dark Current vs. Ambient Temperature



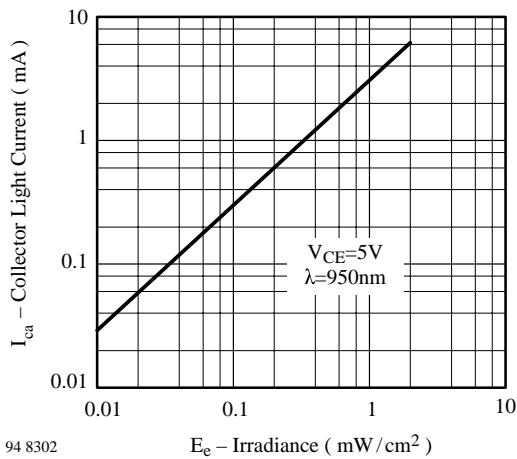
94 8239

Figure 3. Relative Collector Current vs. Ambient Temperature



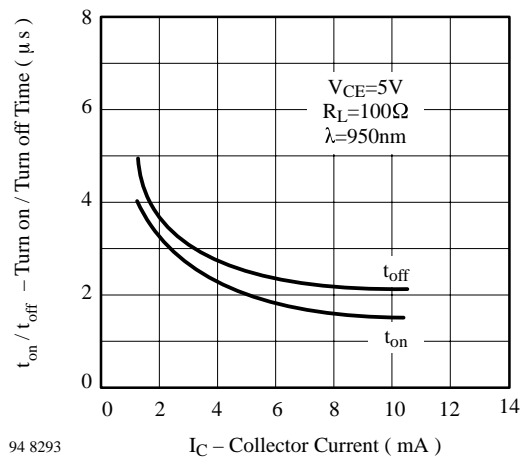
94 8294

Figure 6. Collector Emitter Capacitance vs. Collector Emitter Voltage



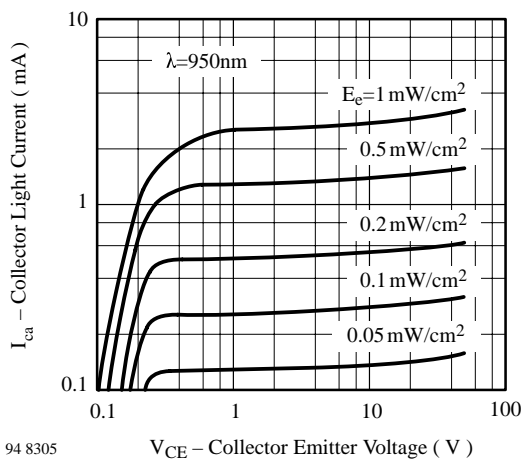
94 8302

Figure 4. Collector Light Current vs. Irradiance



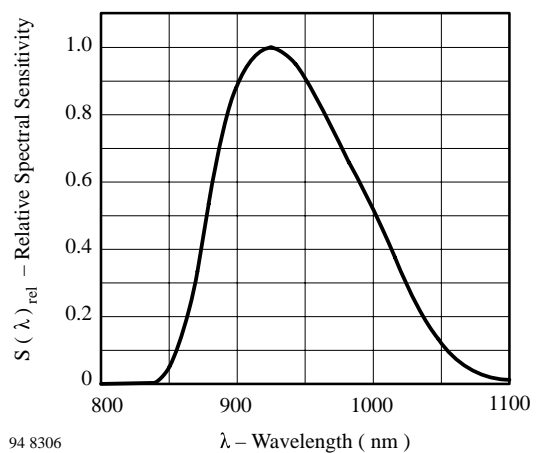
94 8293

Figure 7. Turn On/Turn Off Time vs. Collector Current



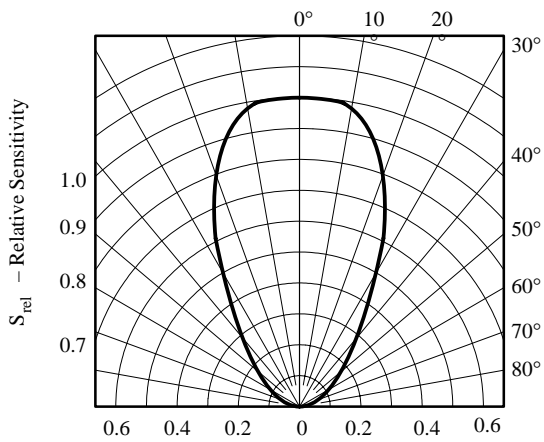
94 8305

Figure 5. Collector Light Current vs. Collector Emitter Voltage



94 8306

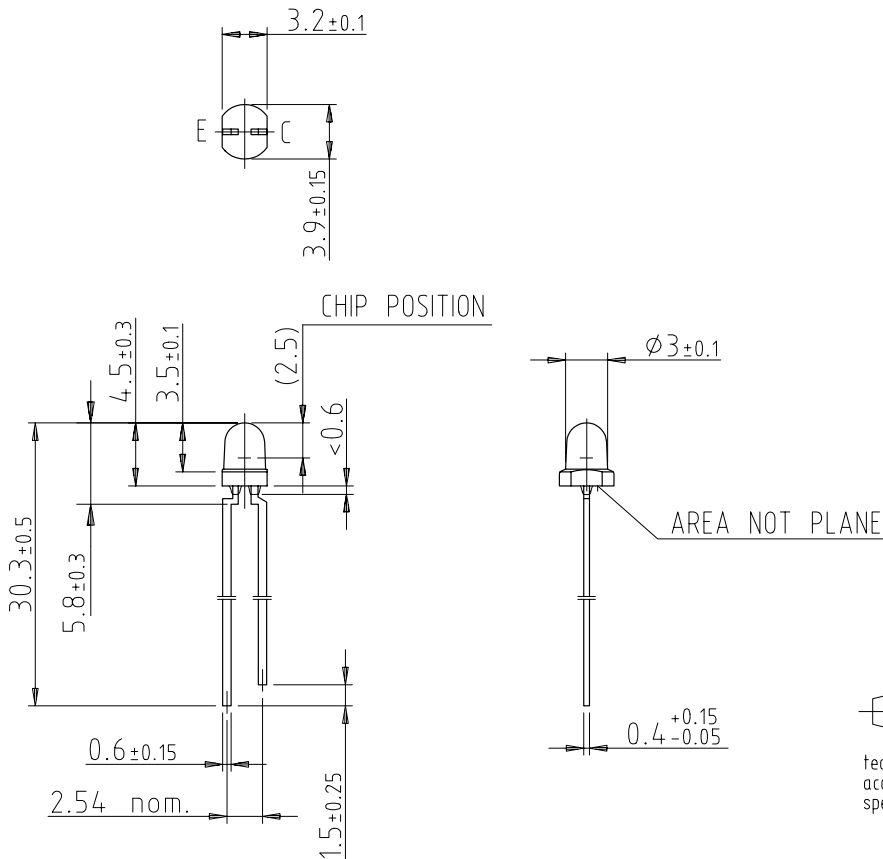
Figure 8. Relative Spectral Sensitivity vs. Wavelength



94 8303

Figure 9. Relative Radiant Sensitivity vs. Angular Displacement

Dimensions in mm



96 12172

 technical drawings
 according to DIN
 specifications



Ozone Depleting Substances Policy Statement

It is the policy of **Vishay Semiconductor GmbH** to

1. Meet all present and future national and international statutory requirements.
2. Regularly and continuously improve the performance of our products, processes, distribution and operating systems with respect to their impact on the health and safety of our employees and the public, as well as their impact on the environment.

It is particular concern to control or eliminate releases of those substances into the atmosphere which are known as ozone depleting substances (ODSs).

The Montreal Protocol (1987) and its London Amendments (1990) intend to severely restrict the use of ODSs and forbid their use within the next ten years. Various national and international initiatives are pressing for an earlier ban on these substances.

Vishay Semiconductor GmbH has been able to use its policy of continuous improvements to eliminate the use of ODSs listed in the following documents.

1. Annex A, B and list of transitional substances of the Montreal Protocol and the London Amendments respectively
2. Class I and II ozone depleting substances in the Clean Air Act Amendments of 1990 by the Environmental Protection Agency (EPA) in the USA
3. Council Decision 88/540/EEC and 91/690/EEC Annex A, B and C (transitional substances) respectively.

Vishay Semiconductor GmbH can certify that our semiconductors are not manufactured with ozone depleting substances and do not contain such substances.

We reserve the right to make changes to improve technical design and may do so without further notice.

Parameters can vary in different applications. All operating parameters must be validated for each customer application by the customer. Should the buyer use Vishay-Telefunken products for any unintended or unauthorized application, the buyer shall indemnify Vishay-Telefunken against all claims, costs, damages, and expenses, arising out of, directly or indirectly, any claim of personal damage, injury or death associated with such unintended or unauthorized use.

Vishay Semiconductor GmbH, P.O.B. 3535, D-74025 Heilbronn, Germany
Telephone: 49 (0)7131 67 2831, Fax number: 49 (0)7131 67 2423