

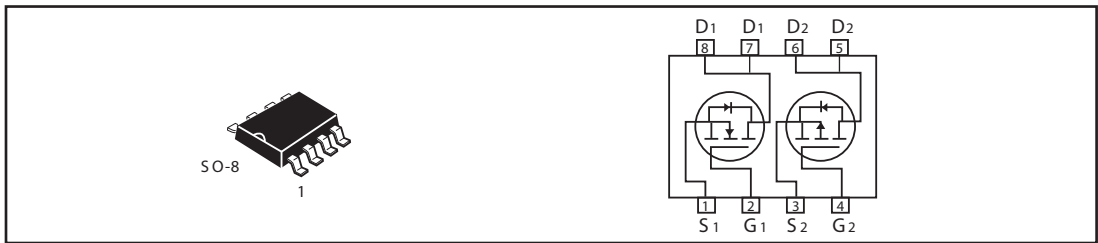

Dual Enhancement Mode Field Effect Transistor (N and P Channel)

PRODUCT SUMMARY (N-Channel)		
V _{DSS}	I _D	R _{DS(ON)} (mΩ) Max
30V	7.2A	25 @ V _{GS} = 10V
		36 @ V _{GS} = 4.5V

PRODUCT SUMMARY (P-Channel)		
V _{DSS}	I _D	R _{DS(ON)} (mΩ) Max
-30V	-5.2A	48 @ V _{GS} = -10V
		72 @ V _{GS} = -4.5V



ABSOLUTE MAXIMUM RATINGS (T_A=25°C unless otherwise noted)

Parameter		Symbol	N-Channel	P-Channel	Unit
Drain-Source Voltage		V _{DS}	30	-30	V
Gate-Source Voltage		V _{GS}	±20	±20	V
Drain Current-Continuous @ T _a	25°C	I _D	7.2	-5.2	A
	70°C		6.1	-4.4	A
-Pulsed ^a		I _{DM}	29	-20	A
Drain-Source Diode Forward Current		I _S	1.7	-1.7	A
Maximum Power Dissipation	T _a =25°C	P _D	2		W
	T _a =70°C		1.44		
Operating Junction and Storage Temperature Range		T _J , T _{STG}	-55 to 150		°C

THERMAL CHARACTERISTICS

Thermal Resistance, Junction-to-Ambient ^a	R _{θJA}	62.5	°C/W
--	------------------	------	------

STM8358S

N-Channel ELECTRICAL CHARACTERISTICS ($T_A = 25\text{ }^{\circ}\text{C}$ unless otherwise noted)

Parameter	Symbol	Condition	Min	Typ ^c	Max	Unit
OFF CHARACTERISTICS						
Drain-Source Breakdown Voltage	BV_{DSS}	$V_{GS} = 0V, I_D = 250\mu A$	30			V
Zero Gate Voltage Drain Current	I_{DSS}	$V_{DS} = 24V, V_{GS} = 0V$			1	μA
Gate-Body Leakage	I_{GSS}	$V_{GS} = \pm 20V, V_{DS} = 0V$			± 100	nA
ON CHARACTERISTICS^b						
Gate Threshold Voltage	$V_{GS(th)}$	$V_{DS} = V_{GS}, I_D = 250\mu A$	1	1.8	3.0	V
Drain-Source On-State Resistance	$R_{DS(ON)}$	$V_{GS} = 10V, I_D = 7A$		17	25	m ohm
		$V_{GS} = 4.5V, I_D = 5A$		22	36	m ohm
On-State Drain Current	$I_{D(ON)}$	$V_{DS} = 5V, V_{GS} = 4.5V$	20			A
Forward Transconductance	g_{FS}	$V_{DS} = 5V, I_D = 7A$		18		S
DYNAMIC CHARACTERISTICS^c						
Input Capacitance	C_{ISS}	$V_{DS} = 15V, V_{GS} = 0V$ $f = 1.0MHz$		810	950	pF
Output Capacitance	C_{OSS}			170		pF
Reverse Transfer Capacitance	C_{RSS}			110		pF
Gate resistance	R_g	$V_{GS} = 0V, V_{DS} = 0V, f = 1.0MHz$		2.2		ohm
SWITCHING CHARACTERISTICS^c						
Turn-On Delay Time	$t_{D(ON)}$	$V_{DD} = 15V$ $I_D = 7A$ $V_{GS} = 10V$ $R_{GEN} = 3\text{ ohm}$		12		ns
Rise Time	t_r			18		ns
Turn-Off Delay Time	$t_{D(OFF)}$			22		ns
Fall Time	t_f			12		ns
Total Gate Charge	Q_g	$V_{DS} = 15V, I_D = 7A, V_{GS} = 10V$		18.5		nC
		$V_{DS} = 15V, I_D = 7A, V_{GS} = 4.5V$		9.2		nC
Gate-Source Charge	Q_{gs}	$V_{DS} = 15V, I_D = 7A$		2.2		nC
Gate-Drain Charge	Q_{gd}	$V_{GS} = 10V$		4.6		nC

STM8358S

P-Channel ELECTRICAL CHARACTERISTICS ($T_A = 25\text{ }^{\circ}\text{C}$ unless otherwise noted)

Parameter	Symbol	Condition	Min	Typ ^c	Max	Unit
OFF CHARACTERISTICS						
Drain-Source Breakdown Voltage	BV_{DSS}	$V_{GS} = 0V, I_D = -250\mu A$	-30			V
Zero Gate Voltage Drain Current	I_{DSS}	$V_{DS} = -24V, V_{GS} = 0V$			-1	μA
Gate-Body Leakage	I_{GSS}	$V_{GS} = \pm 20V, V_{DS} = 0V$			± 100	nA
ON CHARACTERISTICS^b						
Gate Threshold Voltage	$V_{GS(th)}$	$V_{DS} = V_{GS}, I_D = -250\mu A$	-1	-1.7	-3.0	V
Drain-Source On-State Resistance	$R_{DS(ON)}$	$V_{GS} = -10V, I_D = -5A$		40	48	m ohm
		$V_{GS} = -4.5V, I_D = -4A$		60	72	m ohm
On-State Drain Current	$I_{D(ON)}$	$V_{DS} = -5V, V_{GS} = -10V$	20			A
Forward Transconductance	g_{FS}	$V_{DS} = -5V, I_D = -5A$		9		S
DYNAMIC CHARACTERISTICS^c						
Input Capacitance	C_{ISS}	$V_{DS} = -15V, V_{GS} = 0V$ $f = 1.0MHz$		700	833	pF
Output Capacitance	C_{OSS}			175		pF
Reverse Transfer Capacitance	C_{RSS}			115		pF
Gate resistance	R_g	$V_{GS} = 0V, V_{DS} = 0V, f = 1.0MHz$		3		ohm
SWITCHING CHARACTERISTICS^c						
Turn-On Delay Time	$t_{D(ON)}$	$V_{DD} = -15V$ $R_L = 3\text{ ohm}$ $V_{GS} = -10V$ $R_{GEN} = 3\text{ ohm}$		10		ns
Rise Time	t_r			18		ns
Turn-Off Delay Time	$t_{D(OFF)}$			48		ns
Fall Time	t_f			32		ns
Total Gate Charge	Q_g	$V_{DS} = -15V, I_D = -5A, V_{GS} = -10V$		13.8		nC
		$V_{DS} = -15V, I_D = -5A, V_{GS} = -4.5V$		7.2		nC
Gate-Source Charge	Q_{gs}	$V_{DS} = -15V, I_D = -5A$		1.3		nC
Gate-Drain Charge	Q_{gd}	$V_{GS} = -10V$		4.5		nC

STM8358S

ELECTRICAL CHARACTERISTICS ($T_A=25^{\circ}\text{C}$ unless otherwise noted)

Parameter	Symbol	Condition	Min	Typ ^c	Max	Unit
DRAIN-SOURCE DIODE CHARACTERISTICS^b						
Diode Forward Voltage	V_{SD}	$V_{GS} = 0\text{V}, I_S = 1.7\text{A}$	N-Ch	0.8	1.2	V
		$V_{GS} = 0\text{V}, I_S = -1.7\text{A}$	P-Ch	-0.79	-1.2	

Notes

- a. Surface Mounted on FR4 Board, $t \leq 10\text{sec}$.
- b. Pulse Test: Pulse Width $\leq 300\mu\text{s}$, Duty Cycle $\leq 2\%$.
- c. Guaranteed by design, not subject to production testing.

N-Channel

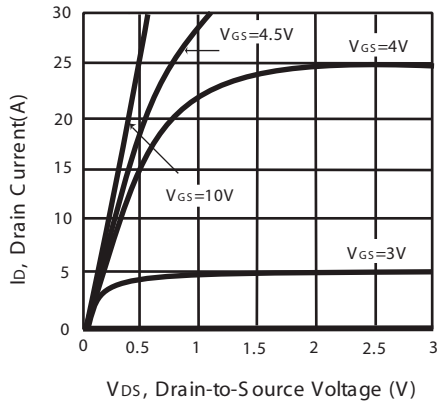

Figure 1. Output Characteristics

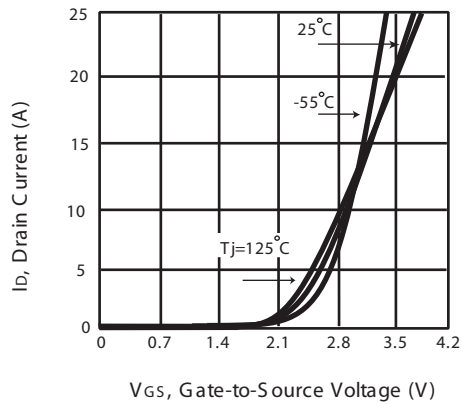

Figure 2. Transfer Characteristics

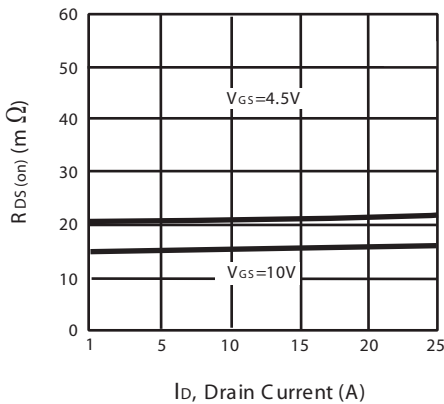

Figure 3. On-Resistance vs. Drain Current and Gate Voltage

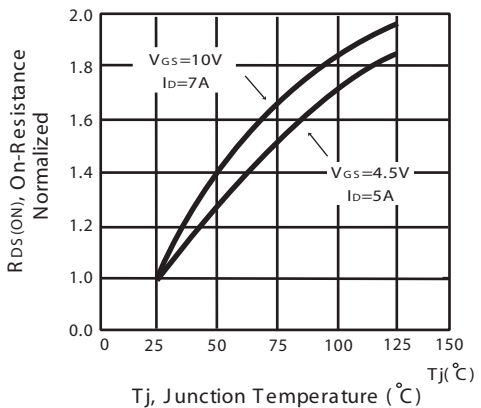

Figure 4. On-Resistance Variation with Drain Current and Temperature

STM8358S

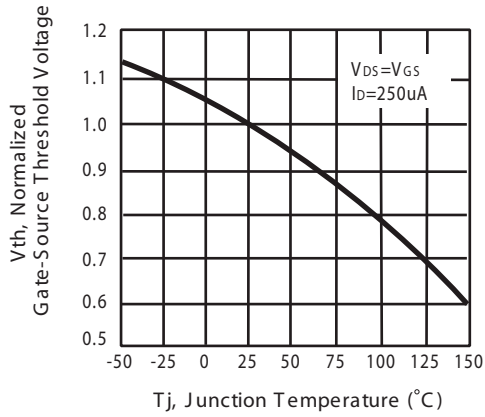

Figure 5. Gate Threshold Variation with Temperature

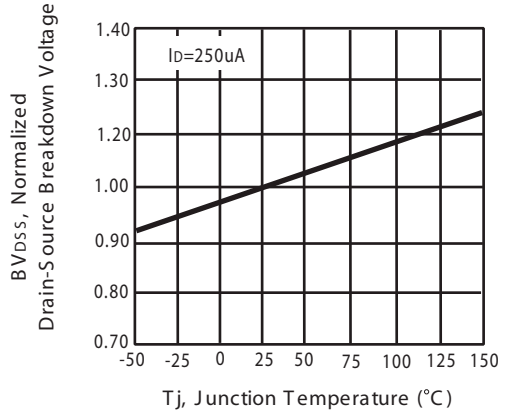

Figure 6. Breakdown Voltage Variation with Temperature

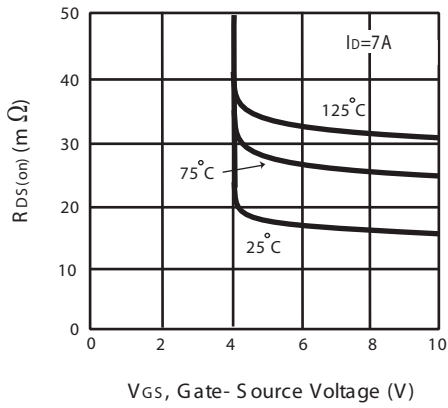

Figure 7. On-Resistance vs. Gate-Source Voltage

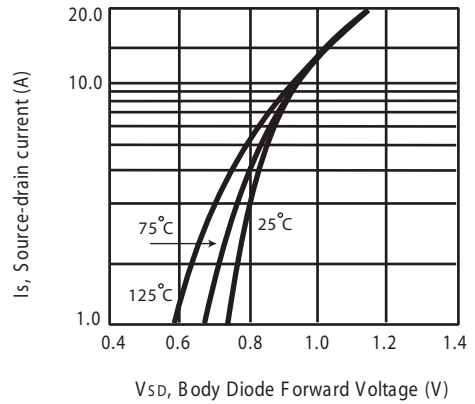

Figure 8. Body Diode Forward Voltage Variation with Source Current

STM8358S

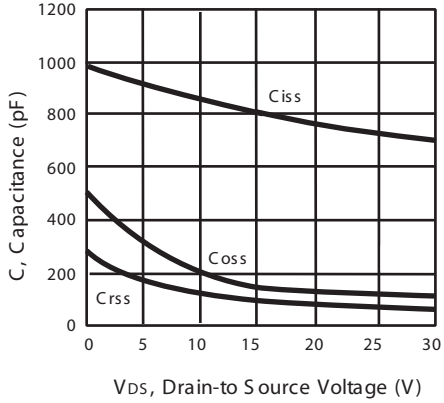

Figure 9. Capacitance

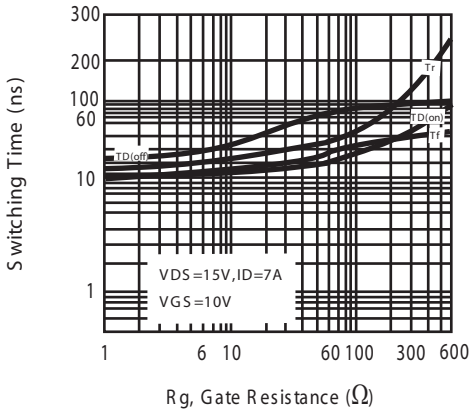
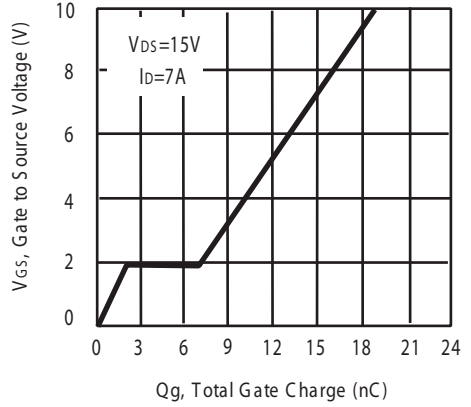

Figure 11. switching characteristics

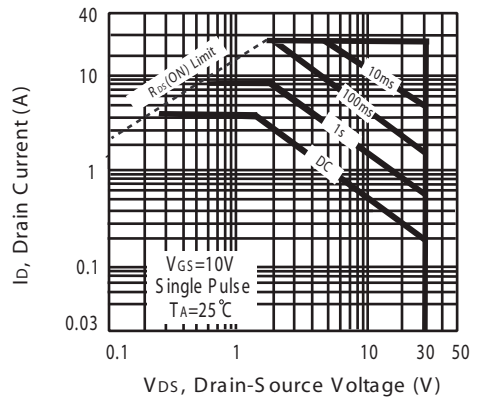

Figure 12. Maximum Safe Operating Area

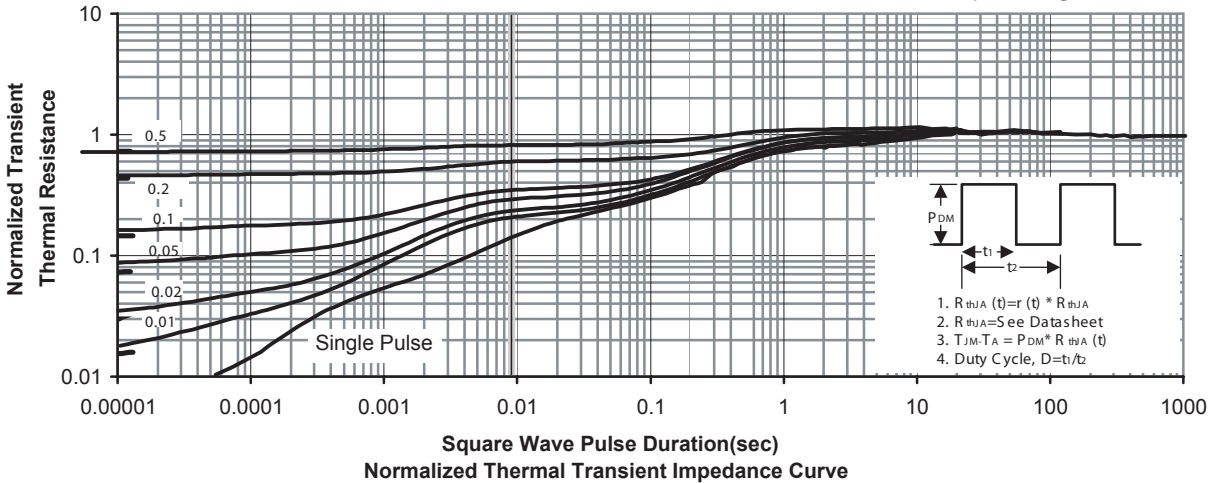

Figure 13. Normalized Thermal Transient Impedance Curve

STM8358S

P-Channel

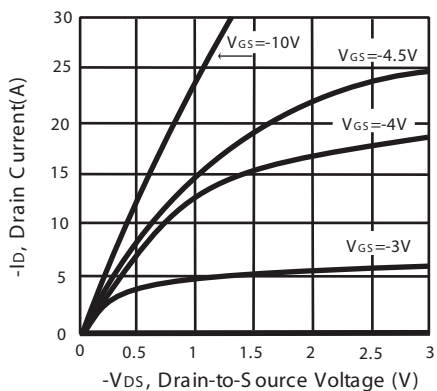

Figure 1. Output Characteristics

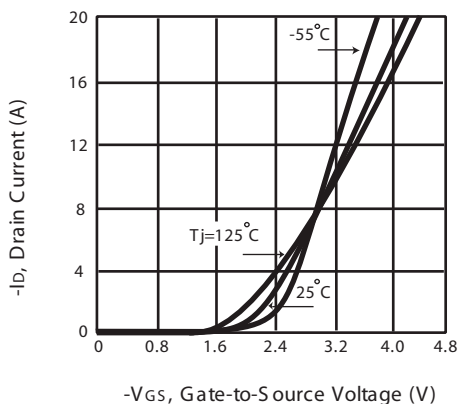

Figure 2. Transfer Characteristics

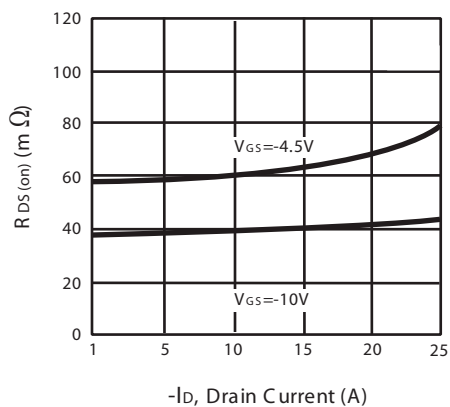

Figure 3. On-Resistance vs. Drain Current and Gate Voltage

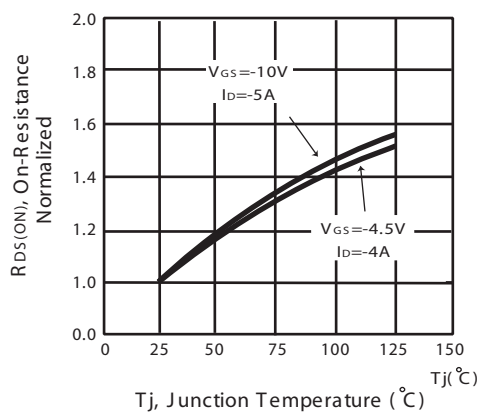

Figure 4. On-Resistance Variation with Drain Current and Temperature

STM8358S

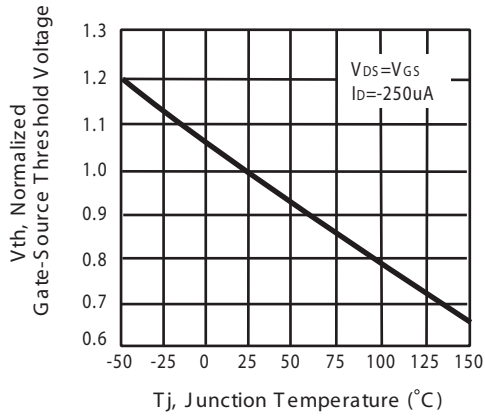

Figure 5. Gate Threshold Variation with Temperature

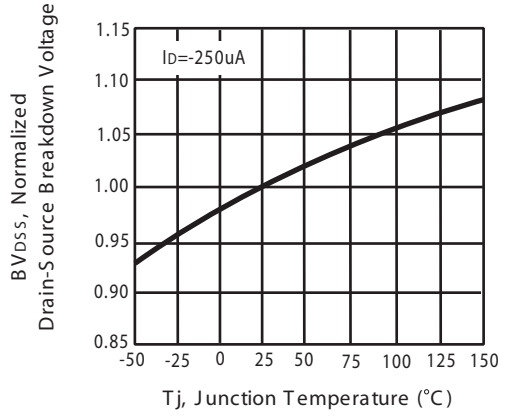

Figure 6. Breakdown Voltage Variation with Temperature

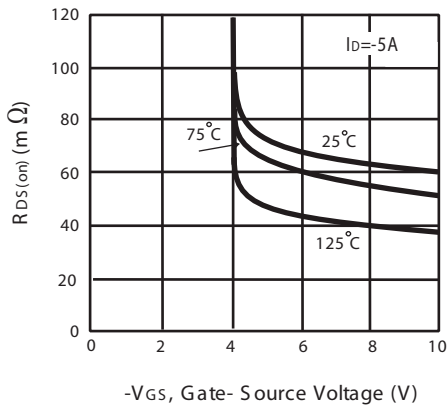

Figure 7. On-Resistance vs. Gate-Source Voltage

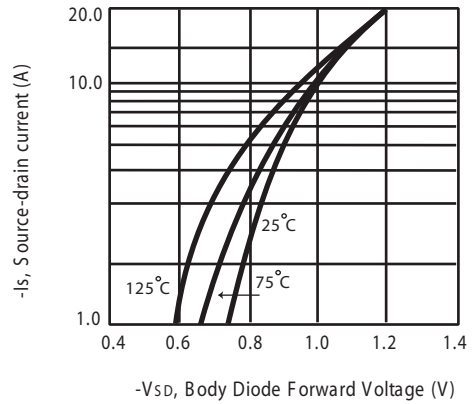

Figure 8. Body Diode Forward Voltage Variation with Source Current

STM8358S

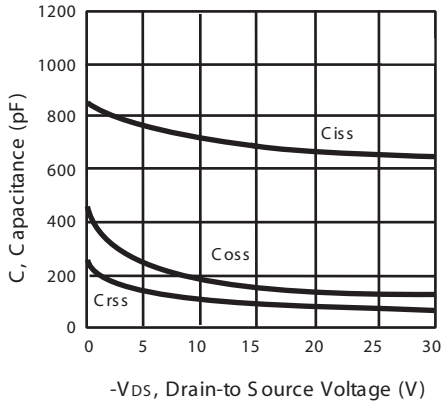

Figure 9. Capacitance

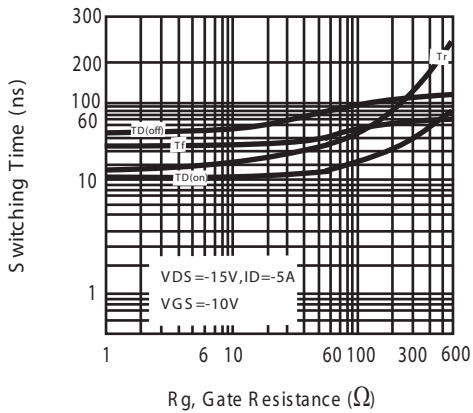
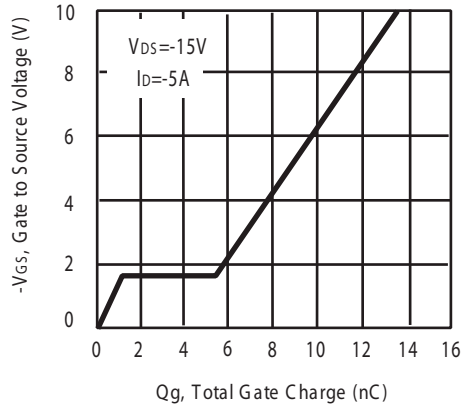

Figure 11. switching characteristics

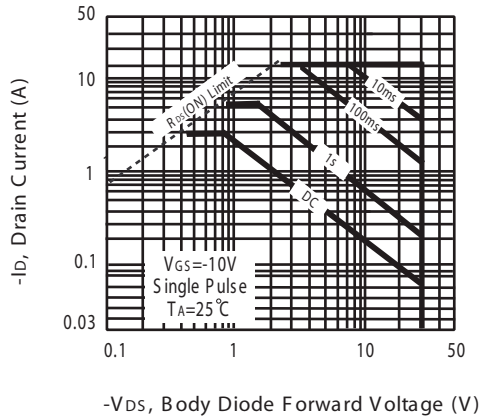

Figure 12. Maximum Safe Operating Area

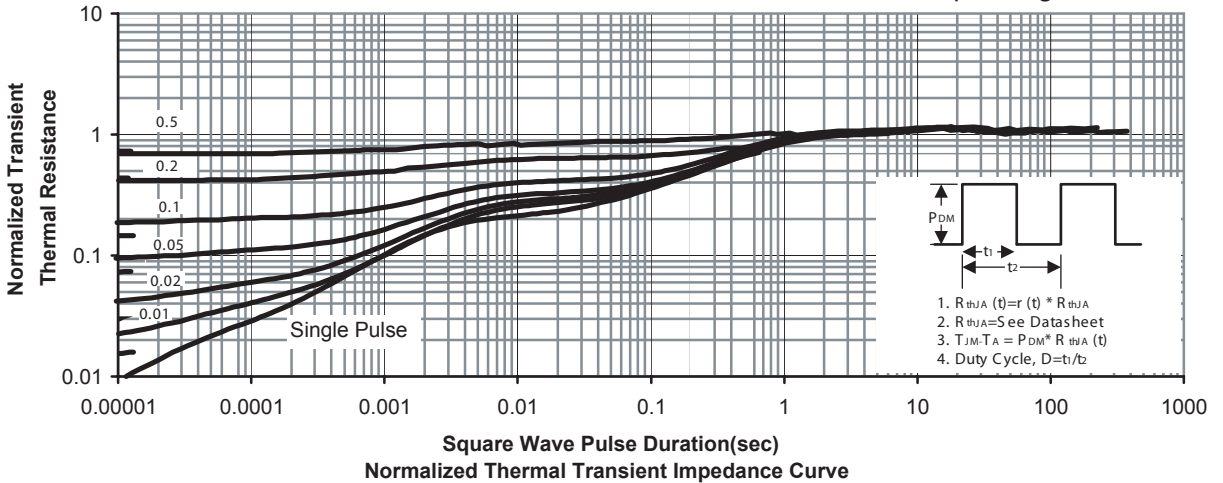
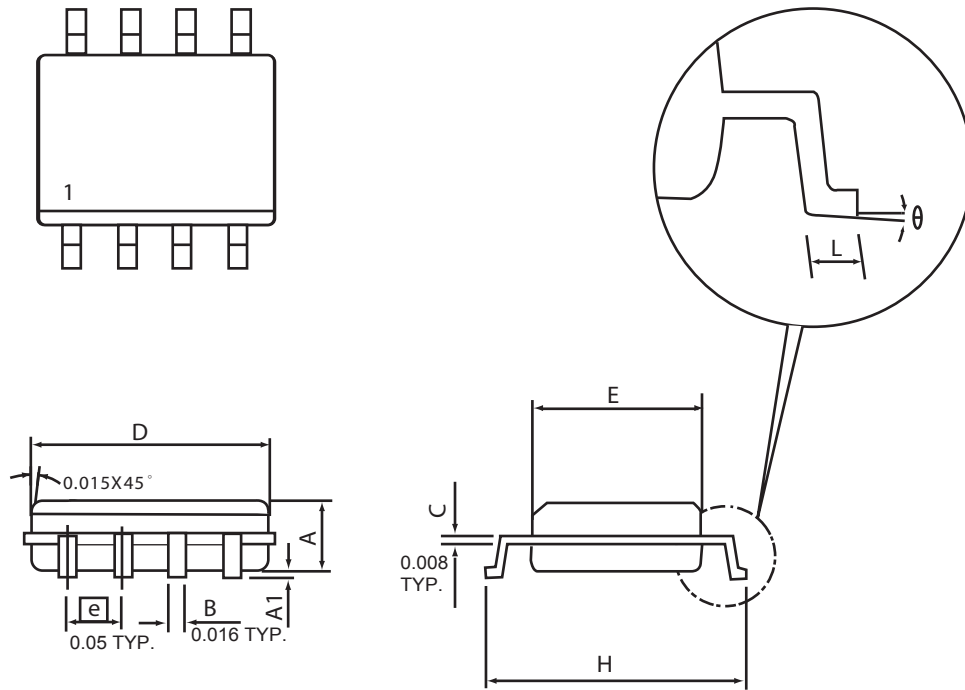

Figure 13. Normalized Thermal Transient Impedance Curve

STM8358S

PACKAGE OUTLINE DIMENSIONS

SO-8



SYMBOLS	MILLIMETERS		INCHES	
	MIN	MAX	MIN	MAX
A	1.35	1.75	0.053	0.069
A1	0.10	0.25	0.004	0.010
D	4.80	4.98	0.189	0.196
E	3.81	3.99	0.150	0.157
H	5.79	6.20	0.228	0.244
L	0.41	1.27	0.016	0.050
θ	0°	8°	0°	8°

STM8358S

SO-8 Tape and Reel Data

SO-8 Carrier Tape

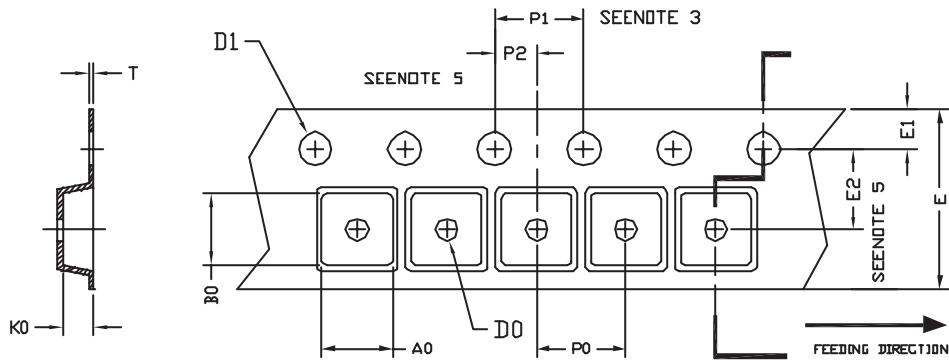

unit:mm

PACKAGE	A0	B0	K0	D0	D1	E	E1	E2	P0	P1	P2	T
SOP 8N 150mil	6.40	5.20	2.10	ϕ 1.5 (MIN)	ϕ 1.5 + 0.1 - 0.0	12.0 \pm 0.3	1.75	5.5 \pm 0.05	8.0	4.0	2.0 \pm 0.05	0.3 \pm 0.05

SO-8 Reel

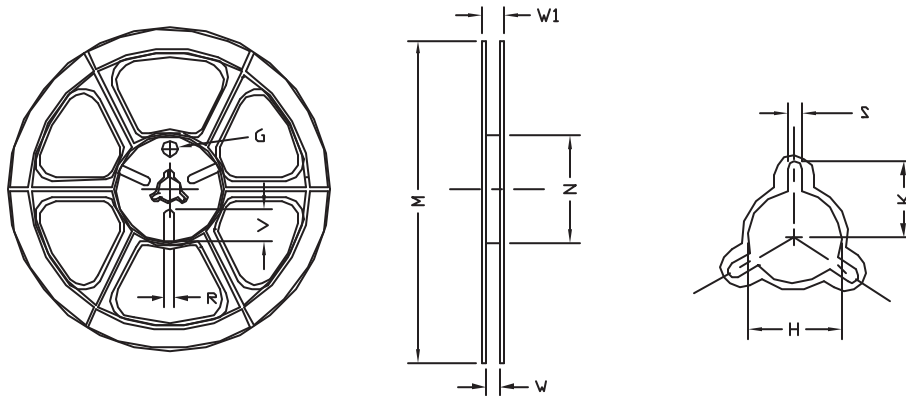

UNIT:mm

TAPE SIZE	REEL SIZE	M	N	W	W1	H	K	S	G	R	V
12 mm	ϕ 330	330 \pm 1	62 \pm 1.5	12.4 + 0.2	16.8 - 0.4	ϕ 12.75 + 0.15	---	2.0 \pm 0.15	---	---	---