

EMI FILTER/TVS ARRAY

APPLICATIONS

- ✓ Cellular Phones
- ✓ SMART Cards
- ✓ Notebooks
- ✓ Personal Digital Assistant (PDA)
- ✓ Ground Positioning System (GPS)

IEC COMPATIBILITY (EN61000-4)

- ✓ 61000-4-2 (ESD): Air - 15kV, Contact - 8kV
- ✓ 61000-4-4 (EFT): 40A - 5/50ns

FEATURES

- ✓ ESD Protection > 25 kilovolts
- ✓ 175 Watts Peak Pulse Power per Line (tp = 8/20µs)
- ✓ Bidirectional EMI Filtering
- ✓ Low Insertion Loss: Up to 10MHz, -3db Roll-Off @ 40MHz
- ✓ Protects Up to Two (2) Data Lines
- ✓ RoHS Compliant in Lead-Free Versions

MECHANICAL CHARACTERISTICS

- ✓ Molded JEDEC SC-70-5L
- ✓ Weight 7 milligrams (Approximate)
- ✓ Available in Tin-Lead or Lead-Free Pure-Tin Plating(Annealed)
- ✓ Solder Reflow Temperature:
 - Tin-Lead - Sn/Pb, 85/15: 240-245°C
 - Pure-Tin - Sn, 100: 260-270°C
- ✓ Flammability Rating UL 94V-0
- ✓ 8mm Tape and Reel Per EIA Standard 481
- ✓ Marking: Marking Code & Pin One Defined By Dot on Top of Package

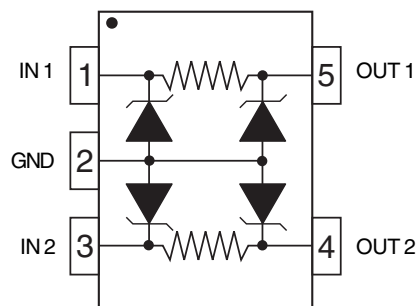
**PIN CONFIGURATION**

DEVICE CHARACTERISTICS

| MAXIMUM RATINGS @ 25°C Unless Otherwise Specified | | | |
|-------------------------------------------------------|-----------|----------------|-------|
| PARAMETER | SYMBOL | VALUE | UNITS |
| Peak Pulse Power ($t_p = 8/20\mu s$) - See Figure 1 | P_{PP} | 175 | Watts |
| Operating Temperature | T_J | -55°C to 150°C | °C |
| Storage Temperature | T_{STG} | -55°C to 150°C | °C |
| Typical Series Resistance per Line | R | 40 | Ohms |

| ELECTRICAL CHARACTERISTICS PER LINE @ 25°C Unless Otherwise Specified | | | | | | | |
|-----------------------------------------------------------------------|----------------|-------------------------|------------------------------|---------------------------------|---------------------------------|----------------------------------|----------------------------------|
| PART NUMBER | DEVICE MARKING | RATED STAND-OFF VOLTAGE | MINIMUM BREAKDOWN VOLTAGE | MAXIMUM REVERSE LEAKAGE CURRENT | MAXIMUM REVERSE LEAKAGE CURRENT | TYPICAL CAPACITOR (Per Junction) | MAXIMUM CAPACITANCE (See Note 1) |
| | | V_{WM} VOLTS | @ 1mA $V^{(BR)}$ VOLTS | @ V_{WM} I_D μA | @ 3.3V I_D μA | @ 0V, 1 MHz C_J pF | @ 0V, 1 MHz C_{TOT} pF |
| STF701 | 05F | 5.0 | 6.0 | 5.0 | 1.0 | 40 | 160 |

Note 1: Capacitance measured between input and output, per line.

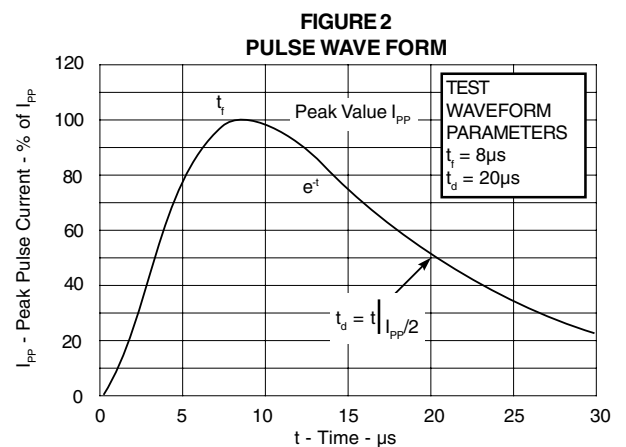
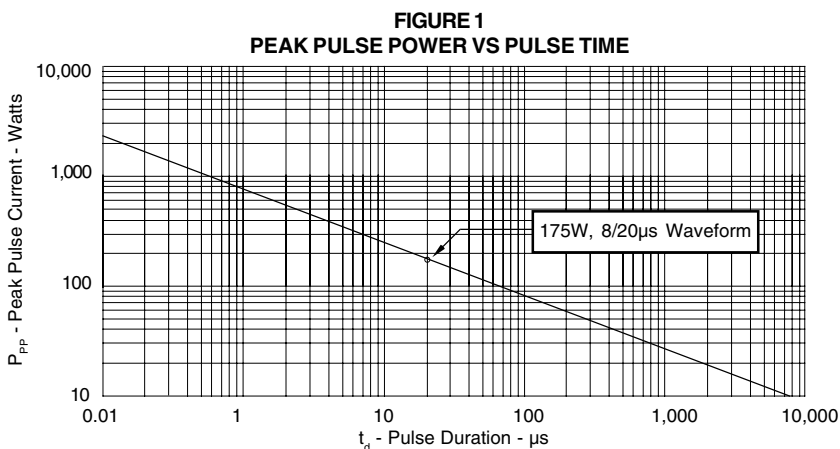

GRAPHS

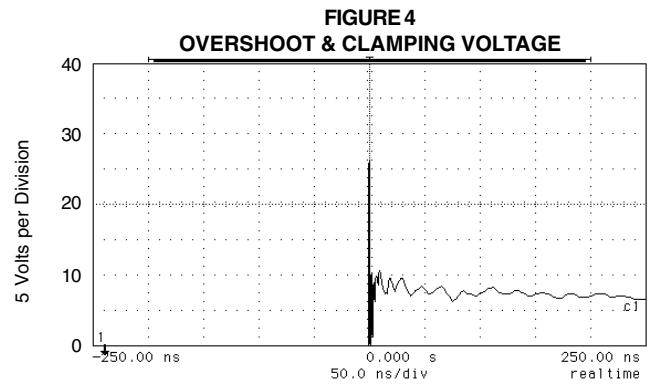
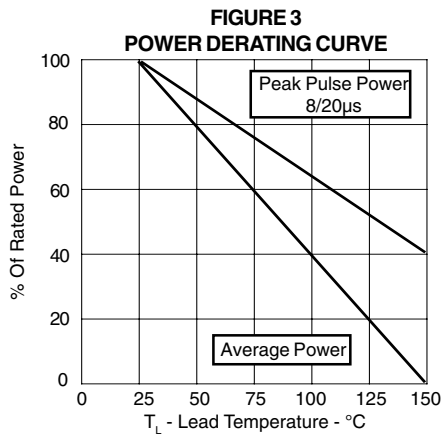

ESD Test Pulse: 25 kilovolt, 1/30ns (waveform)

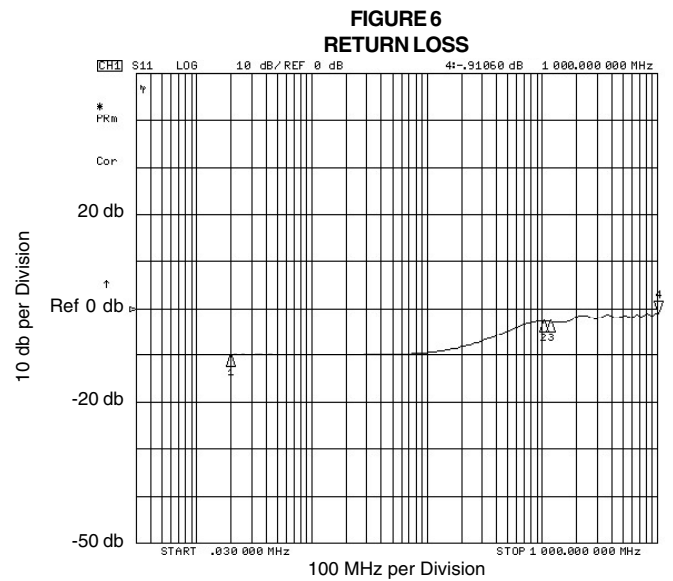
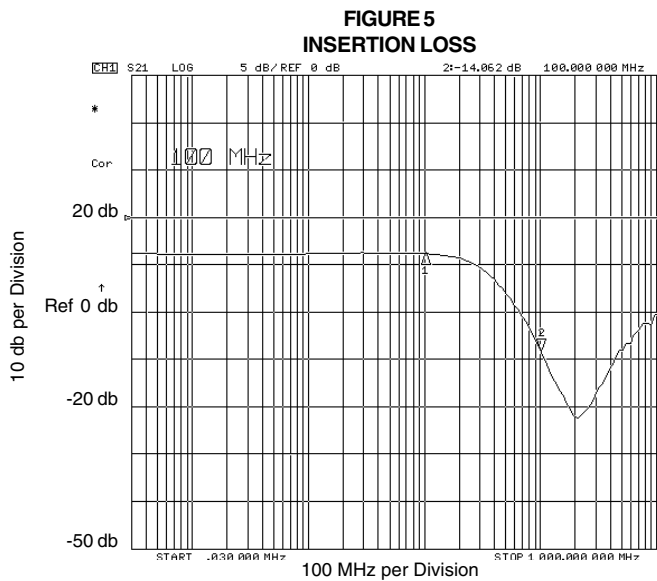

PACKAGE OUTLINE & DIMENSIONS

PACKAGE OUTLINE

SC70-5L

PACKAGE DIMENSIONS

| DIM | MILLIMETERS | | INCHES | |
|-----|-------------|------|------------|-------|
| | MIN | MAX | MIN | MAX |
| A | 1.90 | 2.15 | 0.074 | 0.084 |
| B | 1.15 | 1.35 | 0.045 | 0.055 |
| C | 0.80 | 1.00 | 0.031 | 0.040 |
| D | 0.15 | 0.30 | 0.006 | 0.012 |
| E | 0.65 BSC | - | 0.0255 BSC | - |
| F | 1.30 BSC | - | 0.0512 BSC | - |
| G | 0.80 | 1.10 | 0.031 | 0.043 |
| J | 0.08 | 0.25 | 0.003 | 0.010 |
| K | 1.90 | 2.15 | 0.074 | 0.084 |
| L | 0 | 0.10 | 0 | 0.004 |
| M | 0.26 | 0.46 | 0.010 | 0.018 |

MOUNTING PAD

| TYPICAL | | |
|---------|-------------|--------|
| DIM | Millimeters | Inches |
| 1 | 0.50 | 0.020 |
| 2 | 1.30 | 0.051 |
| 3 | 0.65 | 0.026 |
| 4 | 1.72 | 0.068 |
| 5 | 0.60 | 0.024 |
| 6 | 1.11 | 0.044 |
| 7 | 2.33 | 0.092 |

NOTES

- Dimensioning and tolerances per ANSI Y14.5M, 1985.
- Controlling Dimension: Inches
- Dimensions are exclusive of mold flash and metal burrs.

TAPE & REEL ORDERING NOMENCLATURE

- Surface mount product is taped and reeled in accordance with EIA-481.
- Suffix-T7 = 7 Inch Reel - 3,000 pieces per 8mm tape, i.e., STF701-T7.
- Suffix-LF = Lead-Free, Pure Tin Plating, i.e., STF701-LF-T7.

Outline & Dimensions: Rev 2 - 10/05, 06005

Tape & Reel Specifications (Dimensions in millimeters)

| Reel Dia. | Tape Width | A0 | B0 | K0 | D | E | F | W | P0 | P2 | P | tmax |
|------------|------------|-------------|-------------|-------------|-------------|-------------|-------------|-------------|-------------|-------------|-------------|------|
| 178mm (7") | 8mm | 2.25 ± 0.10 | 2.34 ± 0.10 | 1.22 ± 0.10 | 1.50 ± 0.10 | 1.75 ± 0.10 | 3.50 ± 0.05 | 8.00 ± 0.30 | 4.00 ± 0.10 | 2.00 ± 0.05 | 4.00 ± 0.10 | 0.25 |

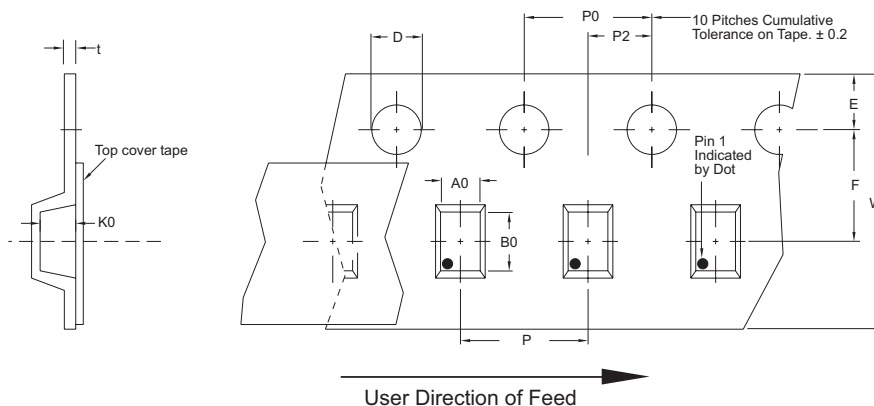

COPYRIGHT © ProTek Devices 2005

SPECIFICATIONS: ProTek reserves the right to change the electrical and or mechanical characteristics described herein without notice (except JEDEC).

DESIGN CHANGES: ProTek reserves the right to discontinue product lines without notice, and that the final judgement concerning selection and specifications is the buyer's and that in furnishing engineering and technical assistance, ProTek assumes no responsibility with respect to the selection or specifications of such products.

ProTek Devices
 2929 South Fair Lane, Tempe, AZ 85282
 Tel: 602-431-8101 Fax: 602-431-2288
 E-Mail: sales@protekdevices.com
 Web Site: www.protekdevices.com