

## NON-ISOLATED DC/DC CONVERTERS

2.4 Vdc - 5.5 Vdc Input

0.75 Vdc - 3.63 Vdc/16 A Output

**bel**  
POWER PRODUCTS

SRBC-16F2Bx

RoHS Compliant

Rev.A

- Non-Isolated
- High Efficiency
- High Power Density
- Fixed Frequency (300 kHz)
- OCP/SCP
- Flexible Output Voltage Sequencing
- Remote On/Off
- Under-voltage Lockout (UVLO)
- Over Temperature Protection
- Wide Input Range
- Wide Trim Range
- Remote Sense
- Converter can sink and source current
- Active Low/High (Option)



### Description

The Bel SRBC-16F2Bx modules are a series of non-isolated dc/dc converters that deliver up to 16 A of output current with full load efficiency of 94% at 3.3 Vdc output. These modules provide precisely regulated voltage programmable via external resistor from 0.75 Vdc to 3.63 Vdc over a wide range of input voltage (2.4 Vdc - 5.5 Vdc). These modules have a sequencing feature that enables designers to implement various types of output voltage sequencing when powering multiple voltages on a board. The open-frame construction and small footprint enable designers to develop cost and space-efficient solutions. Standard features include remote On/Off, remote sense, over current protection, short current protection, wide input, and programmable output voltage.

### Part Selection

Output Voltage	Input Voltage	Max. Output Current	Max. Output Power	Typical Efficiency	Model Number Active Low	Model Number Active High
0.75 V - 3.63 V <sup>1</sup>	2.4 V - 5.5 V	16 A	58.1 W	94%	SRBC-16F2BL	SRBC-16F2B0

- Notes:**
1. These modules use a buck topology, so the output voltages must be 0.8 V less than the input voltage.
  2. Add "G" to the end of the Model Number to indicate Tray Packaging.
  3. All part numbers above indicate RoHS 6. Change the second letter "R" to "7" for RoHS 5 part numbers.

### Absolute Maximum Ratings

Parameter	Min	Typ	Max	Notes
Input Voltage (continuous)	-0.3 V	-	5.8 V	
Output Enable Terminal Voltage	-0.3 V	-	5.8 V	
Sequencing Voltage <sup>1</sup>	-0.3 V	-	V <sub>in</sub>	
Ambient Temperature	-40 °C	-	85 °C	
Storage Temperature	-55 °C	-	125 °C	

- Notes:** All specifications are typical at 25 °C unless otherwise stated.
1. SRBC-16F2Bx series of modules include a sequencing feature that enables users to implement various types of output voltage sequencing in their applications. This is accomplished via an additional sequencing pin. When the sequencing feature is not used, tie the SEQ pin to V<sub>in</sub> or leave the SEQ pin floating.

## NON-ISOLATED DC/DC CONVERTERS

2.4 Vdc - 5.5 Vdc Input

0.75 Vdc - 3.63 Vdc/16 A Output



### Input Specifications

Parameter	Min	Typ	Max	Notes
Input Voltage	2.4 V	-	5.5 V	$V_{o, set} \leq V_{in} - 0.8 V$
Input Current (full load)				
$V_o = 3.3 V$	-	11.23 A	15.10 A	
$V_o = 2.5 V$	-	8.70 A	14.81 A	
$V_o = 1.8 V$	-	6.40 A	13.64 A	
$V_o = 1.5 V$	-	5.45 A	11.76 A	
$V_o = 1.2 V$	-	4.52 A	9.64 A	
$V_o = 0.75 V$	-	3.05 A	6.69 A	
Input Current (no load)	-	80 mA	-	
Remote Off Input Current	-	10 mA	22 mA	
Input Reflected Ripple Current (pk-pk)	-	100 mA	-	Tested with two 100uF/10V tantalum input capacitors (P/N: TPSC107K010R0075 AVX) & simulated source impedance of 1 uH, 5 Hz to 20 MHz.
Input Reflected Ripple Current (rms)	-	40 mA	-	
$I^2t$ Inrush Current Transient	-	0.15 A <sup>2</sup> s	0.3 A <sup>2</sup> s	
Turn-on Voltage Threshold	-	2.2 V	-	
Turn-off Voltage Threshold	-	2.0 V	-	

### Output Specifications

Parameter	Min	Typ	Max	Notes
Output Voltage Set Point	-2% $V_{o, set}$	-	2% $V_{o, set}$	$V_{in} = 5 V$ , $I_o = I_{o, max}$ full load
Output Voltage Set Point	-3% $V_{o, set}$	-	3% $V_{o, set}$	Over all operating input voltages, resistive loads and temperature conditions
Load Regulation	-	0.4% $V_{o, set}$	-	$I_o = I_{o, min}$ to $I_{o, max}$
Line Regulation	-	0.3% $V_{o, set}$	-	$V_{in} = V_{in, min}$ to $V_{in, max}$
Regulation Over Temperature (-40 °C to +85 °C)	-	0.5% $V_{o, set}$	-	$T_{ref} = T_{amin}$ to $T_{amax}$
Output Current	0 A	-	16 A	
Current Limit Threshold	19 A	-	35 A	
Short Circuit Surge Transient	-	1.6 A <sup>2</sup> s	2 A <sup>2</sup> s	
Ripple and Noise (pk-pk)	-	25 mV	50 mV	Tested with 0-20 MHz, 10 uF / 16 V tantalum capacitor & 1 uF / 10 V TDK ceramic capacitor at the output
Ripple and Noise (rms)	-	8 mV	15 mV	
Turn on Time	-	4 mS	8 mS	
Overshoot at Turn on	-	0% $V_{o, set}$	3% $V_{o, set}$	
Output Capacitance				
ESR $\geq 1$ mohm	0 uF	-	1000 uF	
ESR $\geq 10$ mohm	0 uF	-	5000 uF	

## NON-ISOLATED DC/DC CONVERTERS

2.4 Vdc - 5.5 Vdc Input

0.75 Vdc - 3.63 Vdc/16 A Output



### Output Specifications (continued)

Parameter	Min	Typ	Max	Notes
<b>Transient Response</b>				
50% ~ 100% Max Load	-	300 mV	-	di/dt=2.5 A/uS; Vin=5 V; and with 10 uF/16 V tantalum capacitor & 1 uF/10 V ceramic capacitor at the output
Settling Time	-	50 uS	-	
100% ~ 50% Max Load	-	300 mV	-	
Settling Time	-	50 uS	-	
50% ~ 100% Max Load	-	150 mV	-	di/dt=2.5 A/us, Vin=5 V; and with two 150 uF/10 V tantalum capacitors & 1 uF/10 V ceramic capacitor at the output
Settling Time	-	100 uS	-	
100% ~ 50% Max Load	-	150 mV	-	
Settling Time	-	100 uS	-	

**Note:** All specifications are typical at nominal input (Vin=5 V), full load at 25 °C unless otherwise stated.

### General Specifications

Parameter	Min	Typ	Max	Notes
Efficiency				Measured at Vin=5 V, full load
Vo=3.3 V	92%	94%	-	
Vo=2.5 V	90%	92%	-	
Vo=1.8 V	88%	90%	-	
Vo=1.5 V	85%	88%	-	
Vo=1.2 V	82%	85%	-	
Vo=0.75 V	76%	79%	-	
Switching Frequency	250 kHz	300 kHz	350 kHz	
Over Temperature Shutdown	-	125 °C	-	
Output Trim Range (Wide Trim)	0.7525 V	-	3.63 V	
Remote Sense Compensation	-	-	5%	
MTBF	5,438,000 hours			Calculated Per Bell Core SR-332 (Io = Nominal; Ta = 25 °C)
Dimensions				
Inches (L x W x H)	1.30 x 0.53 x 0.315			
Millimeters (L x W x H)	33.02 x 13.46 x 8.00			
Weight	-	6.6 g	-	

**Note:** All specifications are typical at 25 °C unless otherwise stated.

### Control Specifications

Parameter	Min	Typ	Max	Notes
<b>Remote On/Off</b>				
Signal Low (Unit Off)	-0.3 V	-	0.3 V	SRBC-16F2B0; Remote On/Off pin open, Unit on.
Signal High (Unit On)	1.5 V	-	5.8 V	
Signal Low (Unit On)	-0.3 V	-	0.3 V	SRBC-16F2BL; Remote On/Off pin open, Unit on.
Signal High (Unit Off)	1.5 V	-	5.8 V	
Sequencing Voltage	0.05V	-	Vin	Sequencing Voltage should be higher than output voltage.
Sequencing Slew Rate Capability	-	-	2 V/mS	
Sequencing Delay Time	10 mS	-	-	Delay from Vinmin to application of voltage on SEQ pin
Tracking Accuracy				
Power-Up	-	100 mV	200 mV	
Power-Down	-	200 mV	400 mV	

## NON-ISOLATED DC/DC CONVERTERS

2.4 Vdc - 5.5 Vdc Input

0.75 Vdc - 3.63 Vdc/16 A Output

**bel**  
POWER PRODUCTS

### Remote Enable Specifications

The SRBC-16F2BL modules feature an enable pin with negative logic. If not using the enable pin, leave the pin open (the module will be on). During logic\_high, the module is turned off, during logic\_low, the module is turned on. Its inner circuit impedance is shown as figure.

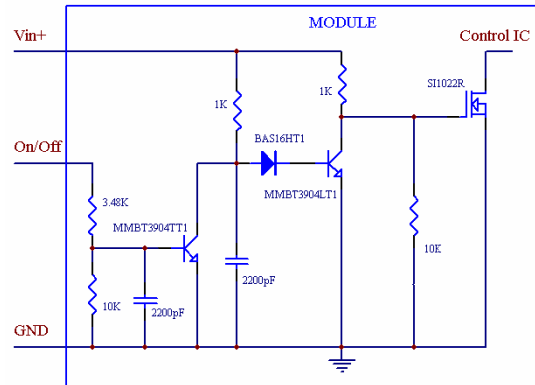

SRBC-16F2BL

The SRBC-16F2B0 modules feature an enable pin with Positive logic. If not using the enable pin, leave the pin open (the module will be on). During logic\_high, the module is turned on, during logic\_low, the module is turned off. Its inner circuit impedance is shown as figure.

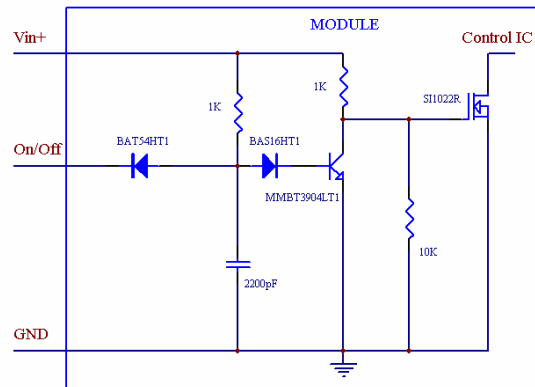

SRBC-16F2B0

### Output Trim Equations

Equation for calculating the trim resistor (in kΩ) given the desired adjusted voltage ( $V_{adj}$ ) is shown below. The Trim Up resistor should be connected between the Trim pin and Ground.

$$R_{trim} = \frac{21.07}{V_{adj} - 0.7525} - 5.11$$

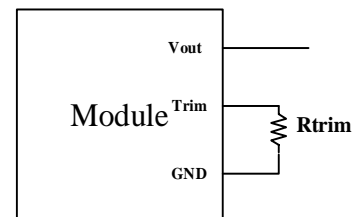

Equation for calculating the trim voltage (in V) given the desired adjusted voltage ( $V_{adj}$ ) is shown below. The Trim Up voltage should be connected between the Trim pin and Ground.

$$V_{trim} = 0.7 - 0.1698 \times (V_{adj} - 0.7525)$$

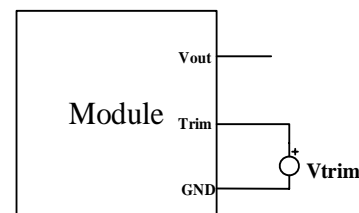

# NON-ISOLATED DC/DC CONVERTERS

2.4 Vdc - 5.5 Vdc Input

0.75 Vdc - 3.63 Vdc/16 A Output



## Efficiency Data

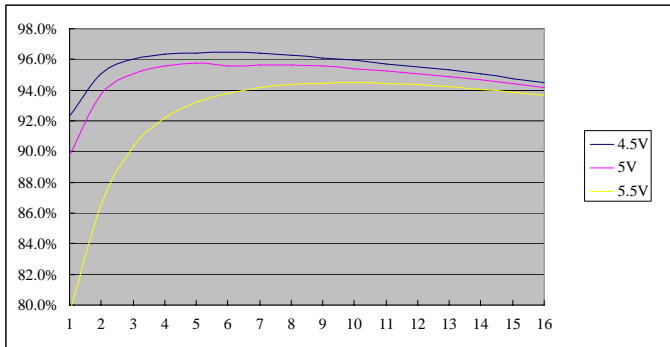

Vo=3.3 V

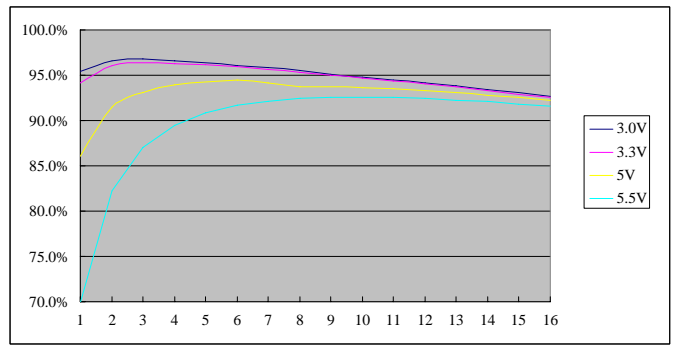

Vo=2.5 V

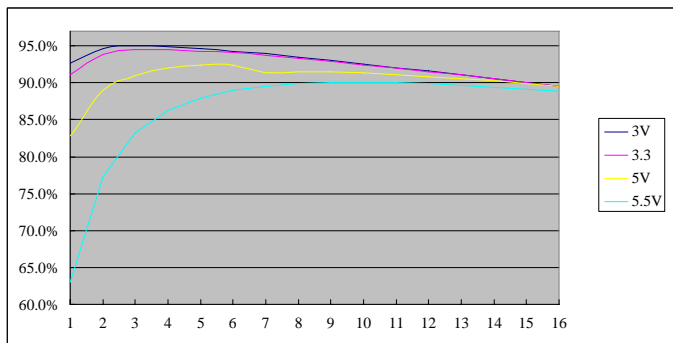

Vo=1.8 V

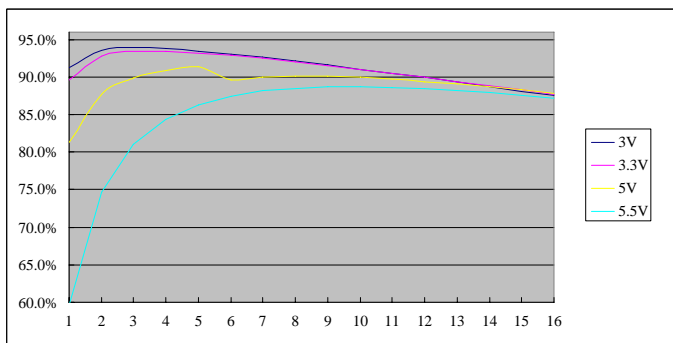

Vo=1.5 V

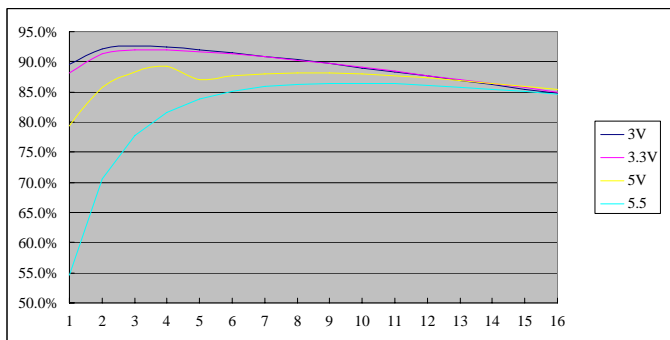

Vo=1.2 V

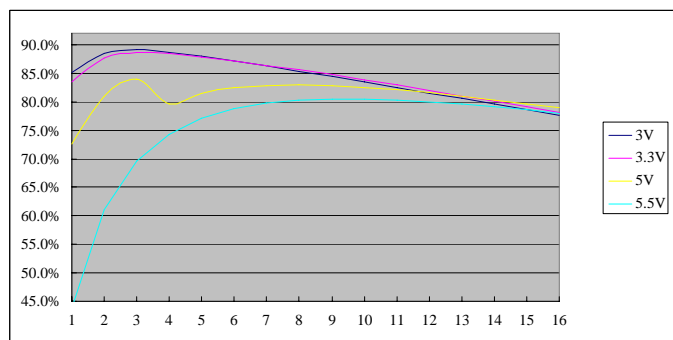

Vo=0.7525 V

# NON-ISOLATED DC/DC CONVERTERS

2.4 Vdc - 5.5 Vdc Input

0.75 Vdc - 3.63 Vdc/16 A Output



## Thermal Derating Curves

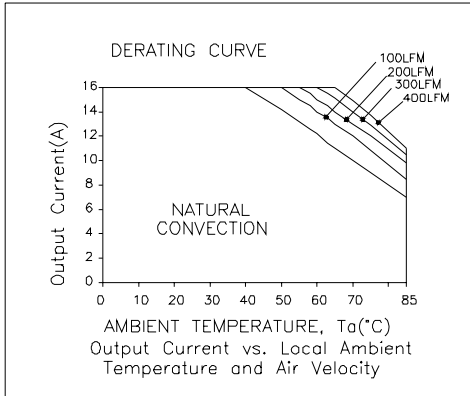

Vin=5.0 V, Vo=2.5 V or 3.3 V

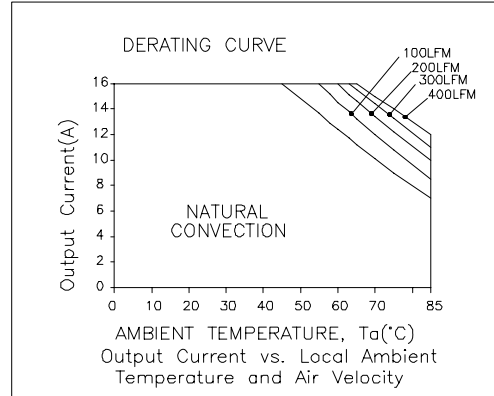

Vin=5.0 V, Vo=1.5 V or 1.8 V

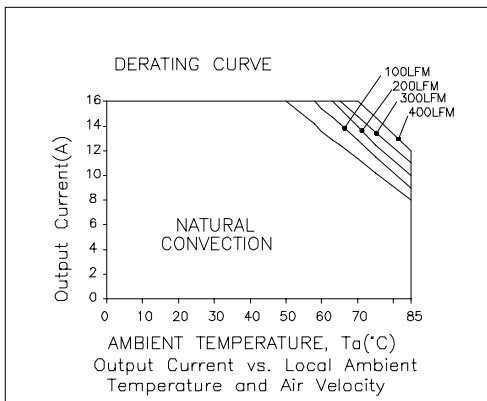

Vin=5.0 V, Vo=0.7525 V or 1.2 V

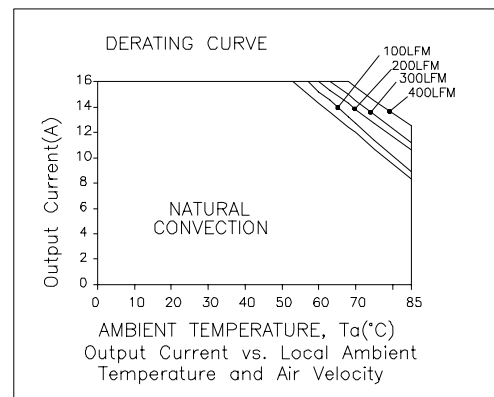

Vin=3.3 V, Vo=1.5 V or 1.8 V

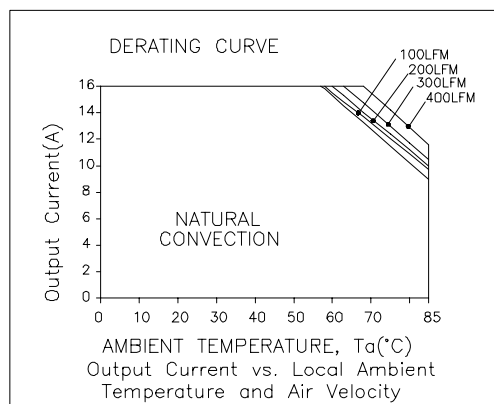

Vin=3.3 V, Vo=0.7525 V or 1.2 V

# NON-ISOLATED DC/DC CONVERTERS

2.4 Vdc - 5.5 Vdc Input

0.75 Vdc - 3.63 Vdc/16 A Output



## Ripple and Noise Waveforms

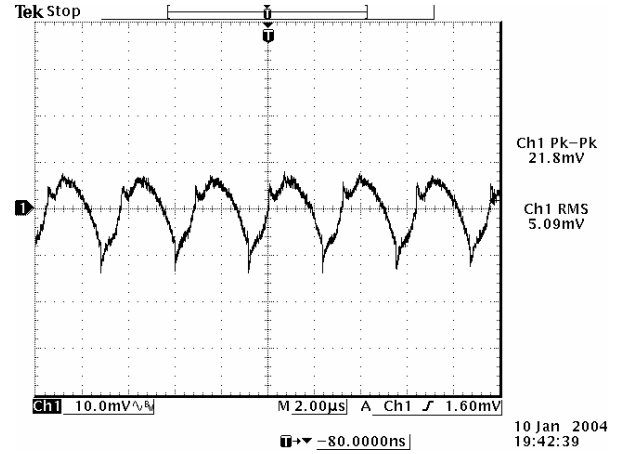
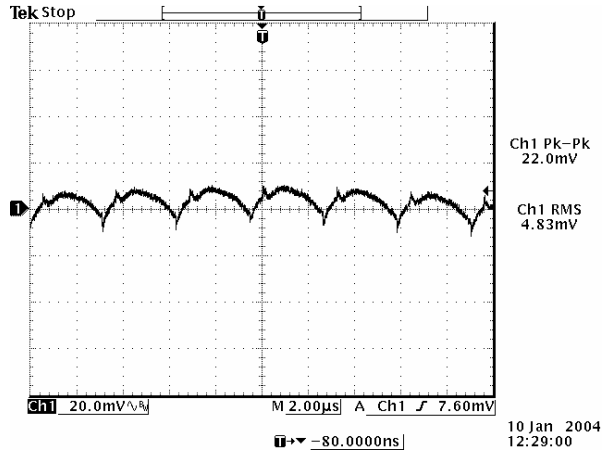

Ripple and noise at full load, 0.75 V output

Ripple and noise at full load, 1.2 V output

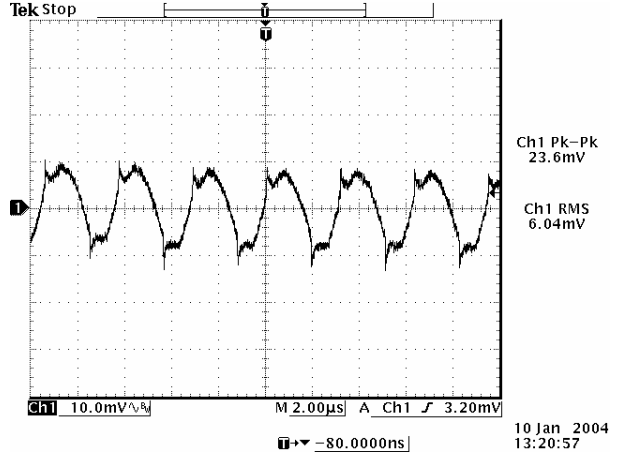
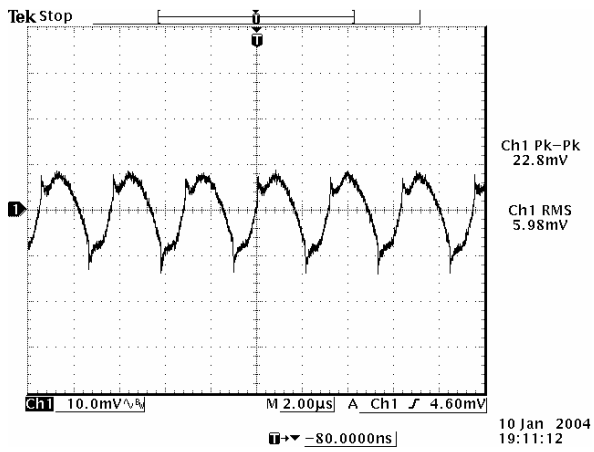

Ripple and noise at full load, 1.5 V output

Ripple and noise at full load, 1.8 V output

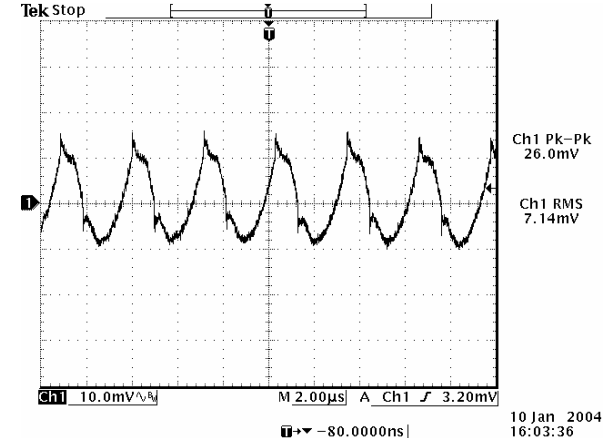
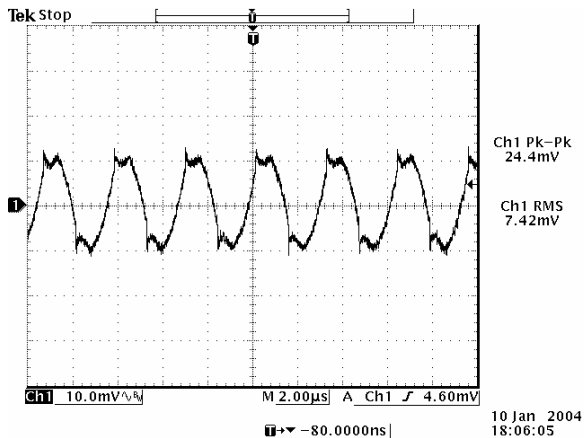

Ripple and noise at full load, 2.5 V output

Ripple and noise at full load, 3.3 V output

**Note:** Ripple and noise at 5.0 V input, 0-20MHz BW, 10 µF/16 V tantalum cap and 1µF/10 V ceramic capacitor, Ta=25 deg C.

# NON-ISOLATED DC/DC CONVERTERS

2.4 Vdc - 5.5 Vdc Input

0.75 Vdc - 3.63 Vdc/16 A Output



## Transient Response Waveforms

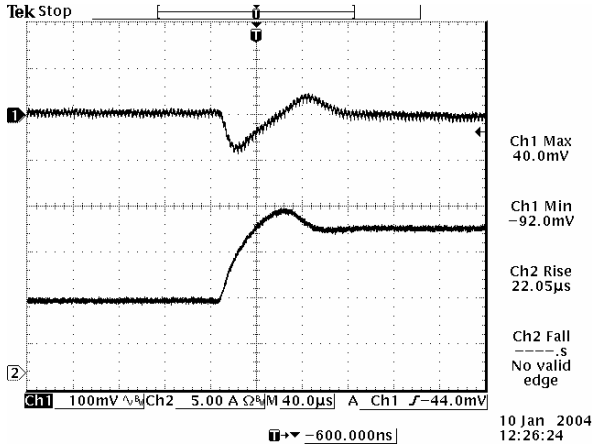

50% to 100% load step at 0.75 V output

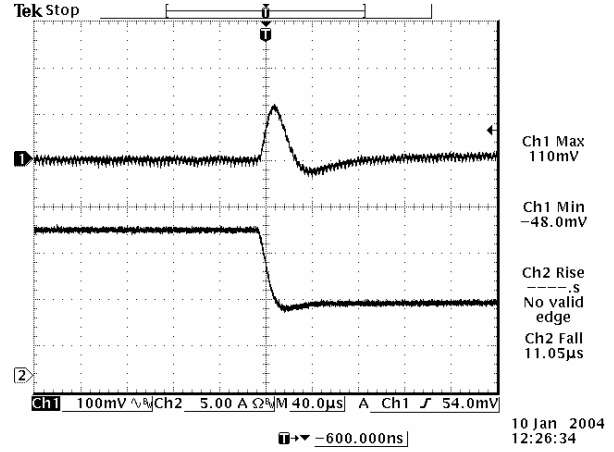

100% to 50% load step at 0.75 V output

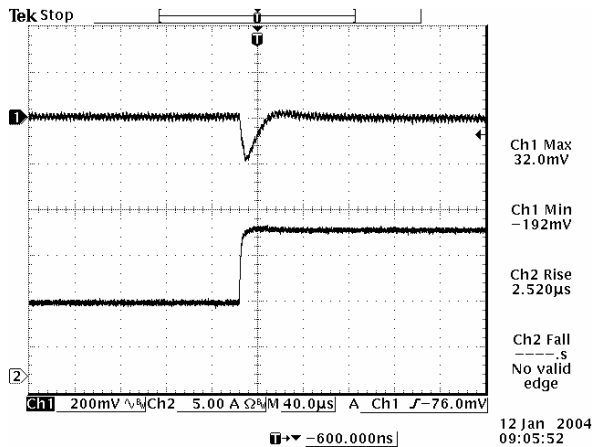

50% to 100% load step at 1.2 V output

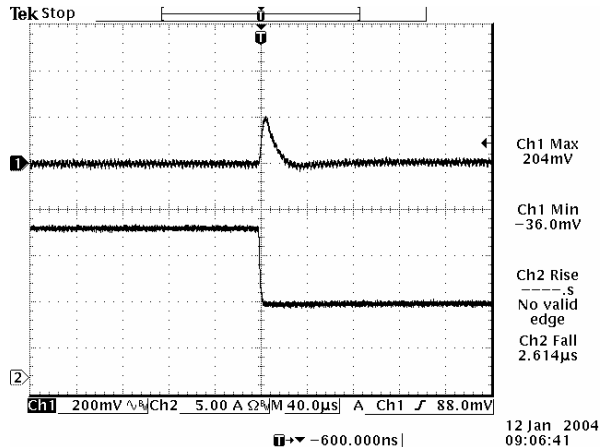

100% to 50% load step at 1.2 V output

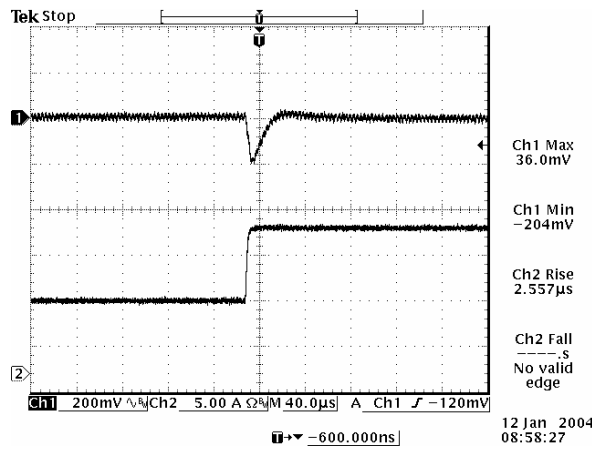

50% to 100% load step at 1.5 V output

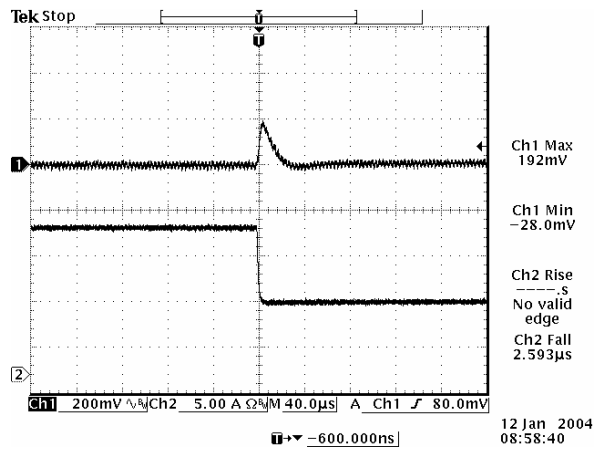

100% to 50% load step at 1.5 V output



# NON-ISOLATED DC/DC CONVERTERS

2.4 Vdc - 5.5 Vdc Input

0.75 Vdc - 3.63 Vdc/16 A Output



## Transient Response Waveforms (continued)

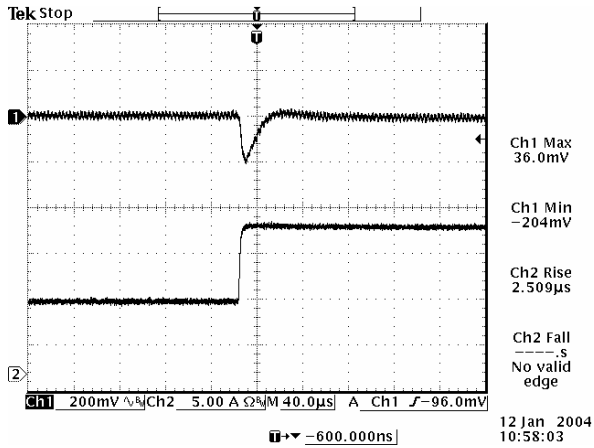

50% to 100% load step at 1.8 V output

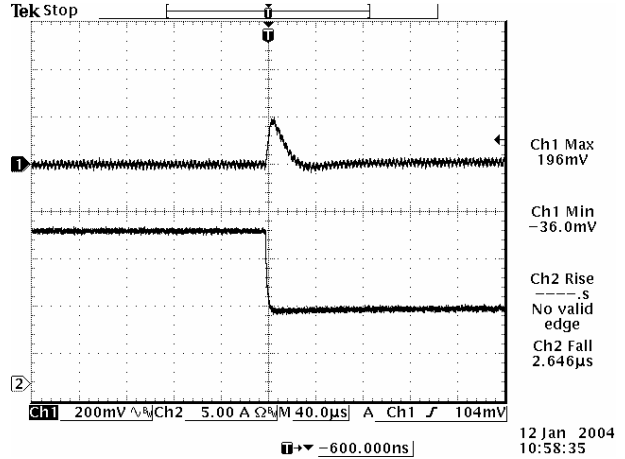

100% to 50% load step at 1.8 V output

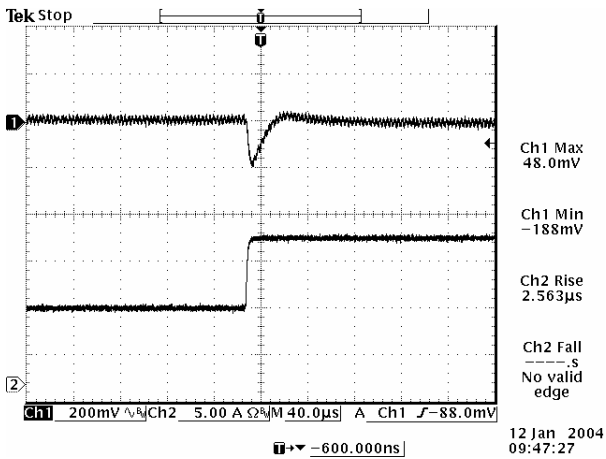

50% to 100% load step at 2.5 V output

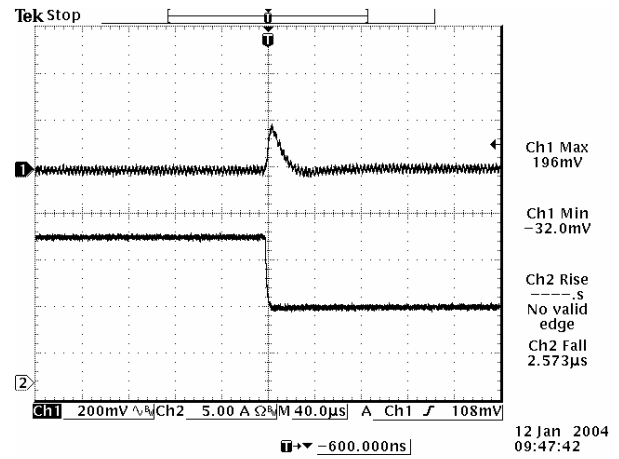

100% to 50% load step at 2.5 V output

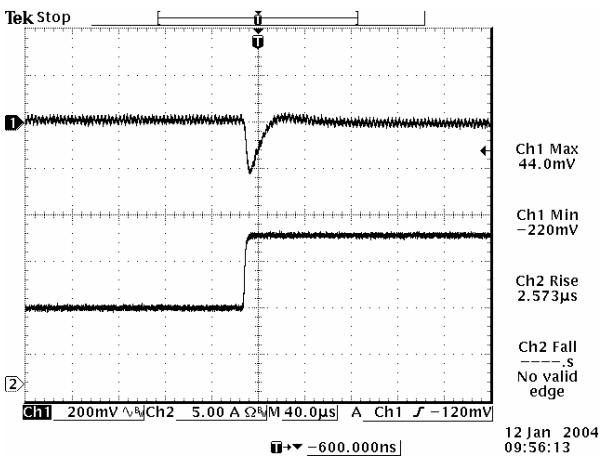

50% to 100% load step at 3.3 V output

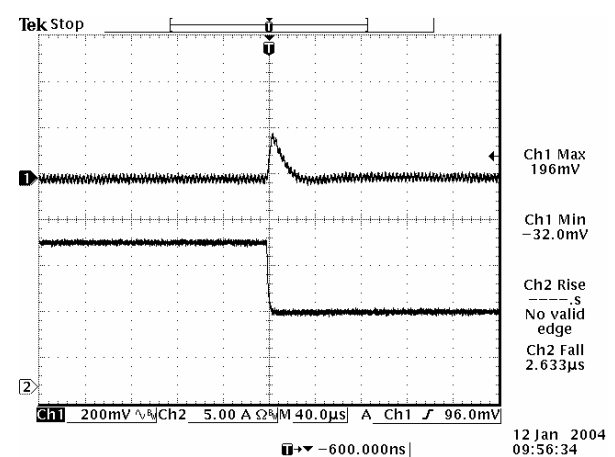

100% to 50% load step at 3.3 V output

**Note:** Transient response at 5.0 V input,  $di/dt=2.5$  A/ $\mu$ S, with two 150  $\mu$ F/10 V tantalum capacitors and 1  $\mu$ F/10 V ceramic capacitor,  $T_a=25$  deg C.

# NON-ISOLATED DC/DC CONVERTERS

2.4 Vdc - 5.5 Vdc Input

0.75 Vdc - 3.63 Vdc/16 A Output



## Mechanical Outline

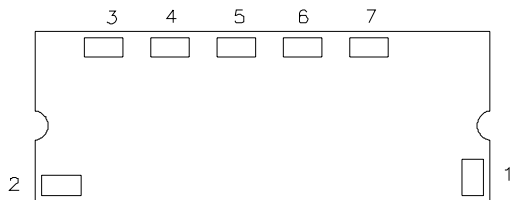
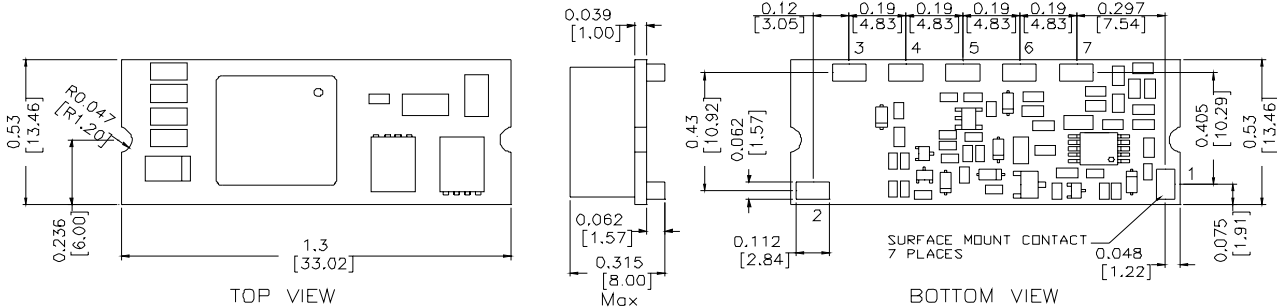

BOTTOM VIEW

RECOMMENDED PAD LAYOUT

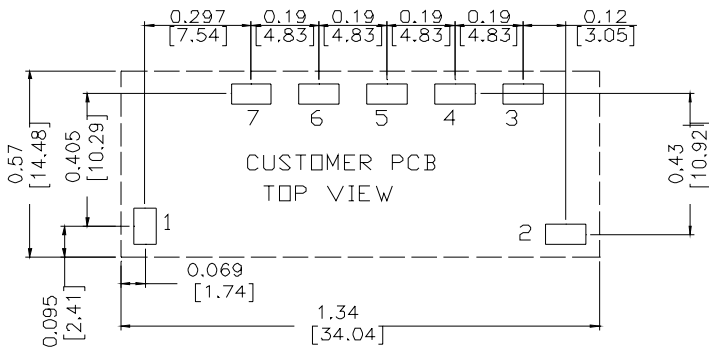

## Pin Connections

Pin	Function
1	Remote On/Off
2	Vin
3	SEQ
4	Ground
5	Vout
6	Trim
7	Remote Sense

### PAD SIZE:

MIN: 0.14" \* 0.095" (3.56mm \* 2.41mm)

MAX: 0.165" \* 0.11" (4.19mm \* 2.79mm)

## RoHS Compliance

Complies with the European Directive 2002/95/EC, calling for the elimination of lead and other hazardous substances from electronic products.



©2007 Bel Fuse Inc. Specifications subject to change without notice. 011807

### CORPORATE

**Bel Fuse Inc.**  
206 Van Vorst Street  
Jersey City, NJ 07302  
Tel 201-432-0463  
Fax 201-432-9542  
[www.belfuse.com](http://www.belfuse.com)

### FAR EAST

**Bel Fuse Ltd.**  
8F/ 8 Luk Hop Street  
San Po Kong  
Kowloon, Hong Kong  
Tel 852-2328-5515  
Fax 852-2352-3706  
[www.belfuse.com](http://www.belfuse.com)

### EUROPE

**Bel Fuse Europe Ltd.**  
Preston Technology Management Centre  
Marsh Lane, Suite G7, Preston  
Lancashire, PR1 8UD, U.K.  
Tel 44-1772-556601  
Fax 44-1772-888366  
[www.belfuse.com](http://www.belfuse.com)