



SPN6435

Dual N-Channel Enhancement Mode MOSFET

DESCRIPTION

The SPN6435 is the Dual N-Channel enhancement mode field effect transistors are produced using high cell density DMOS technology. These products have been designed to minimize on-state resistance while provide rugged, reliable, and fast switching performance. They can be used in most applications requiring up to 300mA DC and can deliver pulsed currents up to 1.0A. These products are particularly suited for low voltage, low current applications such as small servo motor control, power MOSFET gate drivers, and other switching applications.

FEATURES

- ◆ 40V/0.30A , $R_{DS(ON)} = 4.0\Omega @ V_{GS} = 10V$
- ◆ 40V/0.20A , $R_{DS(ON)} = 5.0\Omega @ V_{GS} = 5.0V$
- ◆ 40V/0.02A , $R_{DS(ON)} = 10.0\Omega @ V_{GS} = 2.5V$
- ◆ Super high density cell design for extremely low $R_{DS(ON)}$
- ◆ Exceptional on-resistance and maximum DC current capability
- ◆ SOT-363 package design

APPLICATIONS

- Drivers: Relays, Solenoids, Lamps, Hammers, Display, Memories, Transistors, etc.
- High saturation current capability. Direct Logic-Level Interface: TTL/CMOS
- Battery Operated Systems
- Solid-State Relays

PIN CONFIGURATION (SOT-363 / SC-70-6L)

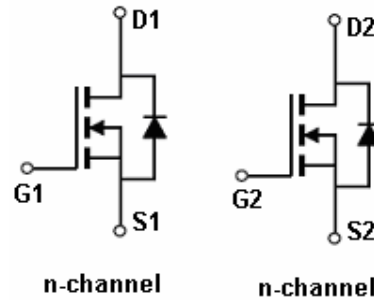
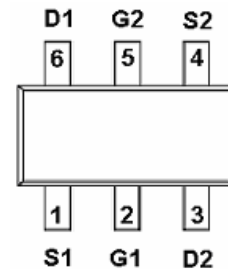

PART MARKING

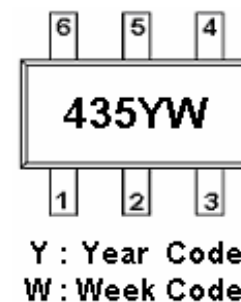



SPN6435

Dual N-Channel Enhancement Mode MOSFET

PIN DESCRIPTION

Pin	Symbol	Description
1	S1	Source 1
2	G1	Gate 1
3	D2	Drain 2
4	S2	Source 2
5	G2	Gate 2
6	D1	Drain1

ORDERING INFORMATION

Part Number	Package	Part Marking
SPN6435S36RG	SOT-363	435YW

※ Week Code : A ~ Z (1 ~ 26) ; a ~ z (27 ~ 52)

※ SPN6435S36RG : Tape Reel ; Pb – Free

ABSOLUTE MAXIMUM RATINGS (TA=25°C Unless otherwise noted)

Parameter	Symbol	Typical	Unit
Drain-Source Voltage	V _{DSS}	40	V
Gate –Source Voltage - Continuous	V _{GSS}	±20	V
Gate –Source Voltage - Non Repetitive (t _p < 50µs)	V _{GSS}	±40	V
Continuous Drain Current(T _J =150°C)	I _D	0.3	A
Pulsed Drain Current (*)	I _{DM}	1.0	A
Continuous Source Current(Diode Conduction)	I _S	0.3	A
Power Dissipation	P _D	0.35	W
Operating Junction Temperature	T _J	-55 ~ 150	°C
Storage Temperature Range	T _{STG}	-55 ~ 150	°C
Thermal Resistance-Junction to Ambient	R _{θJA}	375	°C/W

(*) Pulse width limited by safe operating area



SPN6435

Dual N-Channel Enhancement Mode MOSFET

ELECTRICAL CHARACTERISTICS (T_A=25°C Unless otherwise noted)

Parameter	Symbol	Conditions	Min.	Typ	Max.	Unit
Static						
Drain-Source Breakdown Voltage	V _{(BR)DSS}	V _{GS} =0V, I _D =150μA	40			V
Gate Threshold Voltage	V _{GS(th)}	V _{DS} =V _{GS} , I _D =250μA	1.0		1.3	
Gate Leakage Current	I _{GSS}	V _{DS} =0V, V _{GS} =±20V			±100	nA
Zero Gate Voltage Drain Current	I _{DSS}	V _{DS} =40V, V _{GS} =0V			1	μA
		V _{DS} =40V, V _{GS} =0V T _J =125°C			10	
Drain-Source On-Resistance	R _{DSON}	V _{GS} =10V, I _D =0.3A		2.8	4.0	Ω
		V _{GS} = 5V, I _D =0.2A		3.2	5.0	
		V _{GS} = 2.5V, I _D =0.02A		7.5	10.0	
Forward Transconductance	G _{fs(1)}	V _{DS} = 10 V, I _D = 0.5 A		0.6		S
Diode Forward Voltage	V _{SD(1)}	V _{GS} = 0 V, I _S = 0.12A		0.85	1.5	V
Dynamic						
Total Gate Charge	Q _g	V _{DD} = 30 V, I _D = 1 A, V _{GS} = 5 V		1.4	2.0	nC
Gate-Source Charge	Q _{gs}			0.8		
Gate-Drain Charge	Q _{gd}			0.5		
Input Capacitance	C _{iss}	V _{DS} = 25 V, f = 1 MHz, V _{GS} = 0		43		pF
Output Capacitance	C _{oss}			20		
Reverse Transfer Capacitance	C _{rss}			6		
Turn-On Time	t _{d(on)}	V _{DD} = 30 V, I _D = 0.5 A R _G = 4.7Ω V _{GS} = 4.5 V		5		ns
	t _r			15		
Turn-Off Time	t _{d(off)}			7		
	t _f			8		

(1) Pulsed: Pulse duration = 300 μs, duty cycle 1.5 %.

(2) Pulse width limited by safe operating area.



SPN6435

Dual N-Channel Enhancement Mode MOSFET

TYPICAL CHARACTERISTICS

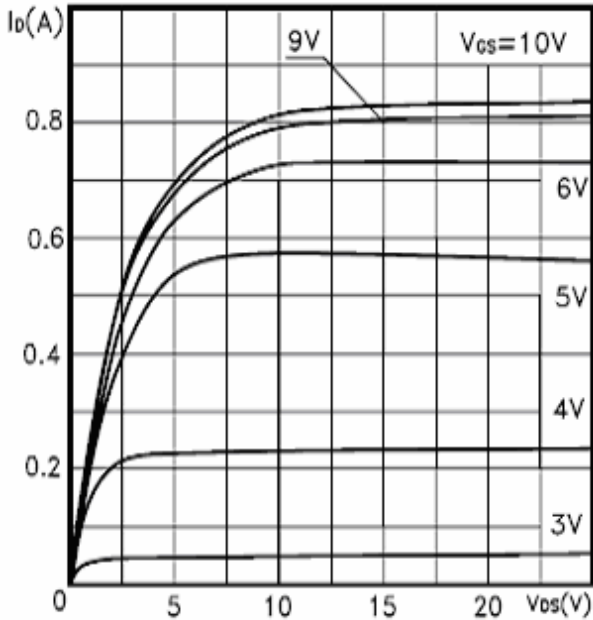

Output Characteristics

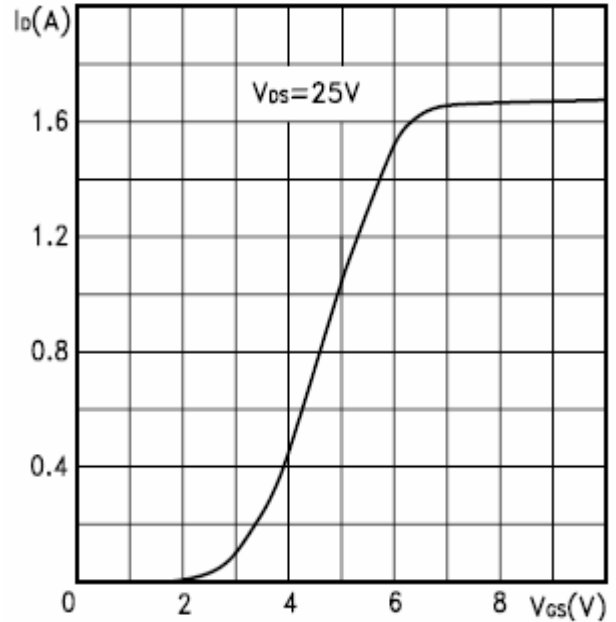

Transfer Characteristics

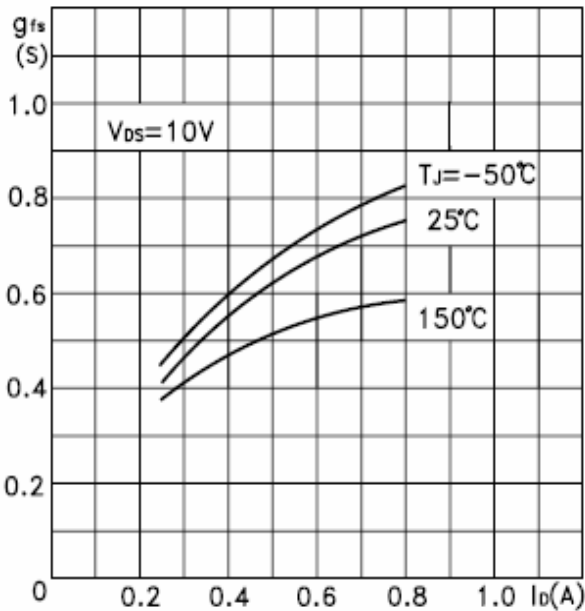

Transconductance

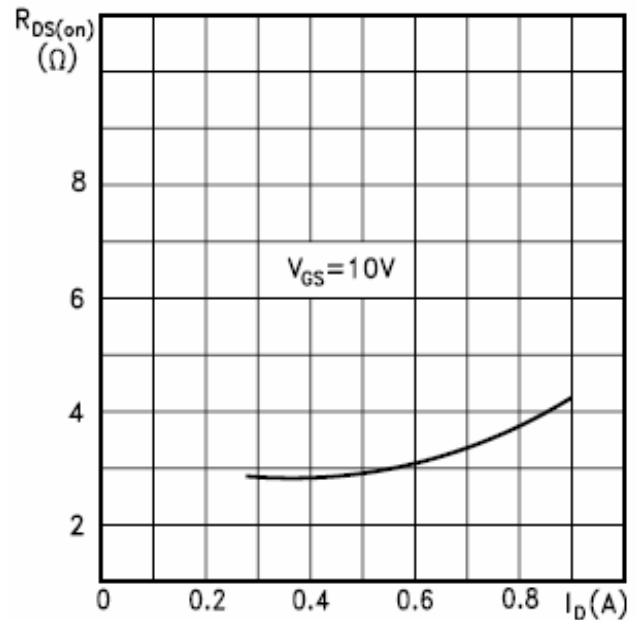

Static Drain-source On Resistance



SPN6435

Dual N-Channel Enhancement Mode MOSFET

TYPICAL CHARACTERISTICS

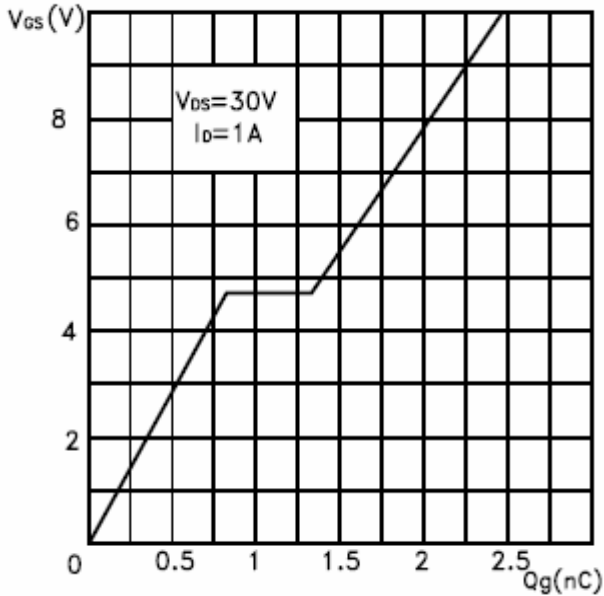

Gate Charge vs Gate-source Voltage

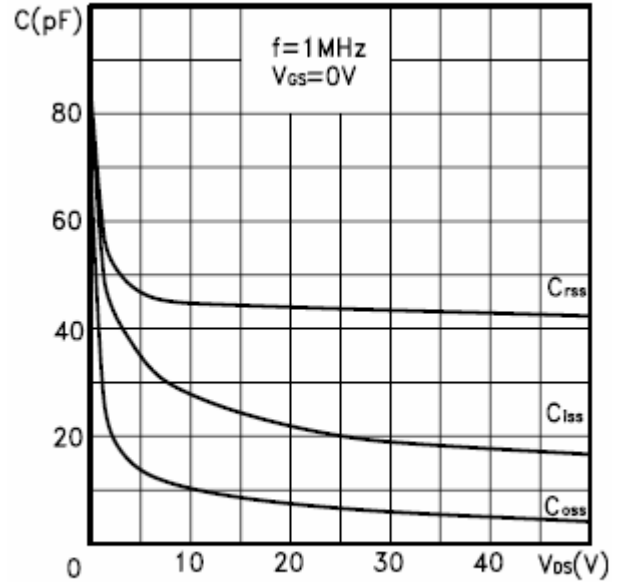

Capacitance Variations

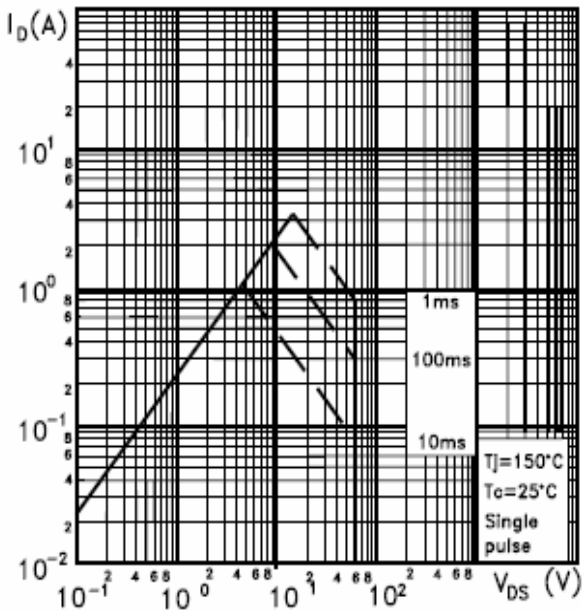

Safe Operating Area

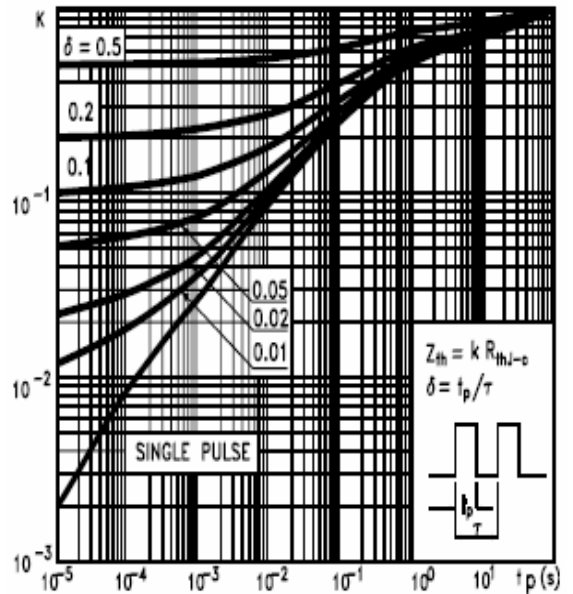

Thermal Impedance



SPN6435

Dual N-Channel Enhancement Mode MOSFET

SOT-363 PACKAGE OUTLINE

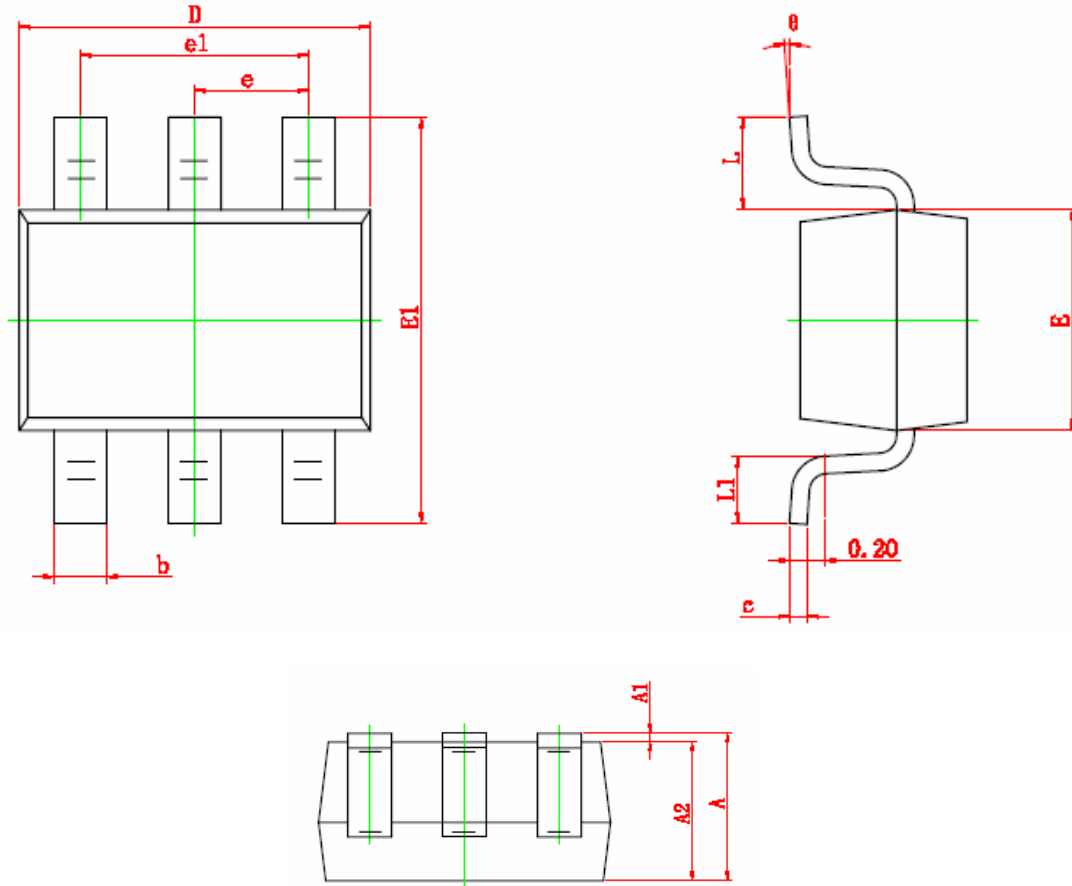

Symbol	Dimensions In Millimeters		Dimensions In Inches	
	Min	Max	Min	Max
A	0.900	1.100	0.035	0.043
A1	0.000	0.100	0.000	0.004
A2	0.900	1.000	0.035	0.039
b	0.150	0.350	0.006	0.014
c	0.080	0.150	0.003	0.006
D	2.000	2.200	0.079	0.087
E	1.150	1.350	0.045	0.053
E1	2.150	2.450	0.085	0.096
e	0.650 TYP		0.026 TYP	
e1	1.200	1.400	0.047	0.055
L	0.525 REF		0.021 REF	
L1	0.260	0.460	0.010	0.018
θ	0°	8°	0°	8°



SPN6435

Dual N-Channel Enhancement Mode MOSFET

Information provided is alleged to be exact and consistent. SYNC Power Corporation presumes no responsibility for the penalties of use of such information or for any violation of patents or other rights of third parties which may result from its use. No license is granted by allegation or otherwise under any patent or patent rights of SYNC Power Corporation. Conditions mentioned in this publication are subject to change without notice. This publication surpasses and replaces all information previously supplied. SYNC Power Corporation products are not authorized for use as critical components in life support devices or systems without express written approval of SYNC Power Corporation.

©The SYNC Power logo is a registered trademark of SYNC Power Corporation

©2004 SYNC Power Corporation – Printed in Taiwan – All Rights Reserved

SYNC Power Corporation

9F-5, No.3-2, Park Street

NanKang District (NKSP), Taipei, Taiwan, 115, R.O.C

Phone: 886-2-2655-8178

Fax: 886-2-2655-8468

©<http://www.syncpower.com>