

SK 60 GAL 123



SEMITOR[®] 2

IGBT Module

SK 60 GAR 123

SK 60 GAL 123

Preliminary Data

Features

- Compact design
- One screw mounting
- Heat transfer and isolation through direct copper bonding aluminium oxide ceramic (DBC)
- High short circuit capability
- NPT (Non-Punch-Through technology)
- $V_{ce(sat)}$ with positive coefficient
- Low tail with low temperature dependance

Typical Applications

- Switching (not for linear use)
- Inverter
- Switched mode power supplies
- UPS

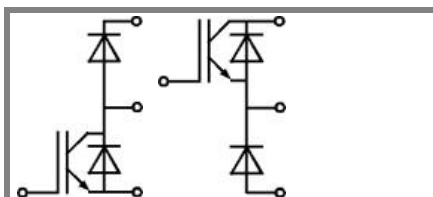

GAL

GAR

| Absolute Maximum Ratings | | $T_s = 25\text{ }^\circ\text{C}$, unless otherwise specified | |
|-------------------------------|---|---|------------------|
| Symbol | Conditions | Values | Units |
| IGBT | | | |
| V_{CES} | | 1200 | V |
| V_{GES} | | ± 20 | V |
| I_C | $T_s = 25\text{ (80) }^\circ\text{C}$; | 58 (40) | A |
| I_{CM} | $t_p < 1\text{ ms}$; $T_s = 25\text{ (80) }^\circ\text{C}$; | 116 (80) | A |
| T_j | | - 40 ... + 150 | $^\circ\text{C}$ |
| Freewheeling CAL diode | | | |
| I_F | $T_s = 25\text{ (80) }^\circ\text{C}$; | 57 (38) | A |
| $I_{FM} = -I_{CM}$ | $t_p < 1\text{ ms}$; $T_s = 25\text{ (80) }^\circ\text{C}$; | 104 (38) | A |
| T_j | | - 40 ... + 150 | $^\circ\text{C}$ |
| T_{stg} | | - 40 ... + 125 | $^\circ\text{C}$ |
| T_{sol} | Terminals, 10 s | 260 | $^\circ\text{C}$ |
| V_{isol} | AC 50 Hz, r.m.s. 1 min. / 1 s | 2500 / 3000 | V |

| Characteristics | | $T_s = 25\text{ }^\circ\text{C}$, unless otherwise specified | | | |
|-------------------------------|---|---|-----------|---------|---------------|
| Symbol | Conditions | min. | typ. | max. | Units |
| IGBT | | | | | |
| $V_{CE(sat)}$ | $I_C = 50\text{ A}$, $T_j = 25\text{ (125) }^\circ\text{C}$ | | 2,5 (3,1) | 3 (3,7) | V |
| $V_{GE(th)}$ | $V_{CE} = V_{GE}$; $I_C = 0,002\text{ A}$ | 4,5 | 5,5 | 6,5 | V |
| C_{res} | $V_{CE} = 25\text{ V}$; $V_{GE} = 0\text{ V}$; 1 MHz | | 3,3 | | nF |
| $R_{th(j-s)}$ | per IGBT | | | 0,6 | K/W |
| | per module | | | | K/W |
| $t_{d(on)}$ | under following conditions: $V_{CC} = 600\text{ V}$, $V_{GE} = \pm 15\text{ V}$ | | 70 | | ns |
| t_r | $I_C = 50\text{ A}$, $T_j = 125\text{ }^\circ\text{C}$ | | 90 | | ns |
| $t_{d(off)}$ | $R_{Gon} = R_{Goff} = 22\text{ }\Omega$ | | 460 | | ns |
| t_f | | | 30 | | ns |
| $E_{on} + E_{off}$ | Inductive load | | 16 | | mJ |
| Freewheeling CAL diode | | | | | |
| $V_F = V_{EC}$ | $I_F = 50\text{ A}$; $T_j = 25\text{ (125) }^\circ\text{C}$ | | 2 (1,8) | 2,5 | V |
| $V_{(TO)}$ | $T_j = (125)\text{ }^\circ\text{C}$ | | (1) | (1,2) | V |
| r_T | $T_j = (125)\text{ }^\circ\text{C}$ | | (18) | (22) | m Ω |
| $R_{th(j-s)}$ | | | | 0,9 | K/W |
| I_{RRM} | under following conditions: $I_F = 50\text{ A}$; $V_R = 600\text{ V}$ | | 40 | | A |
| Q_{rr} | $di_F/dt = -800\text{ A}/\mu\text{s}$ | | 8 | | μC |
| E_{off} | $V_{GE} = 0\text{ V}$; $T_j = 125\text{ }^\circ\text{C}$ | | 2,3 | | mJ |
| Mechanical data | | | | | |
| M1 | mounting torque | | | 2 | Nm |
| w | | | 19 | | g |
| Case | SEMITOR [®] 2 | | T 18 | | |

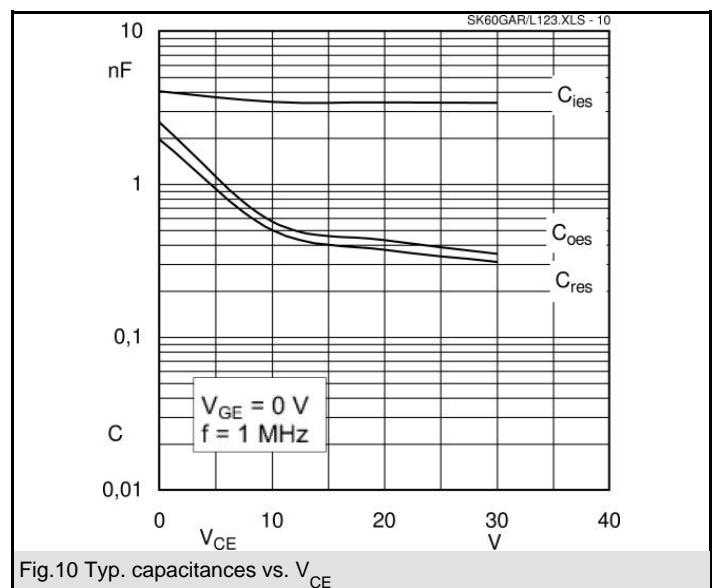
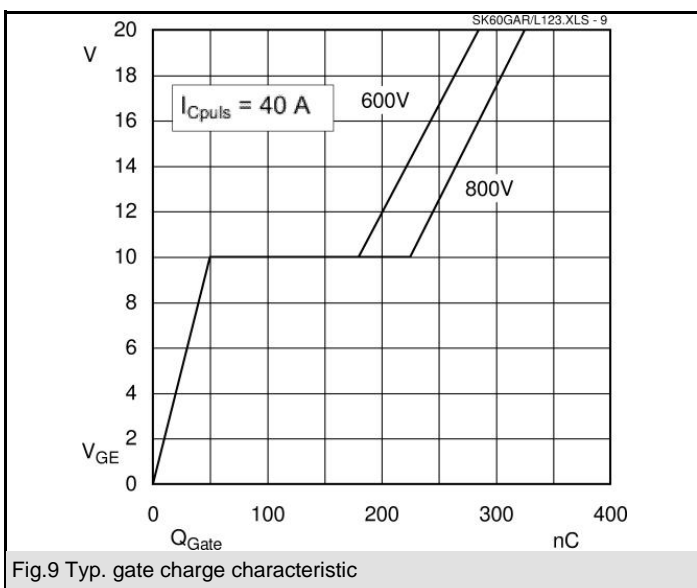
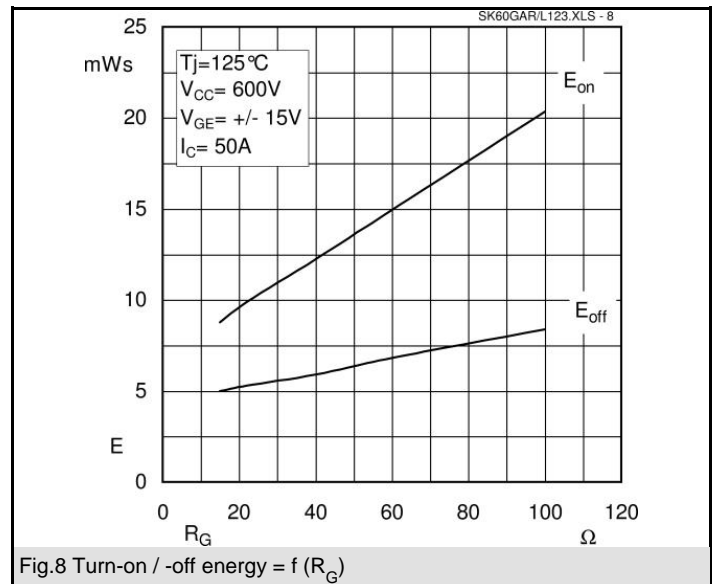
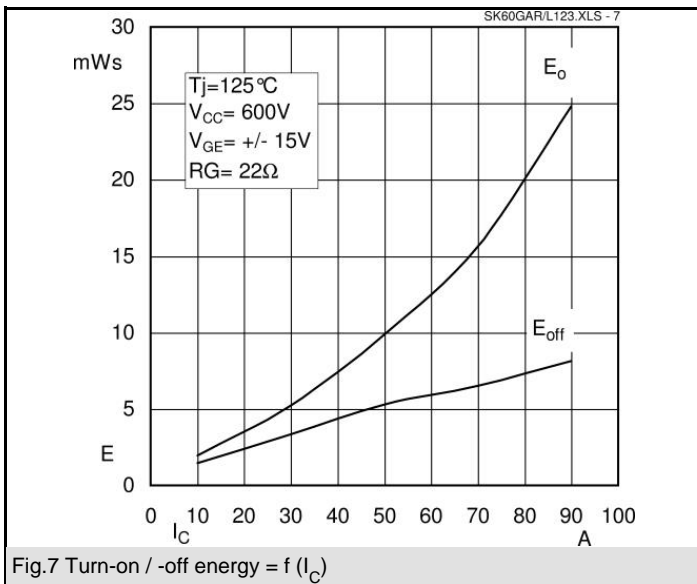
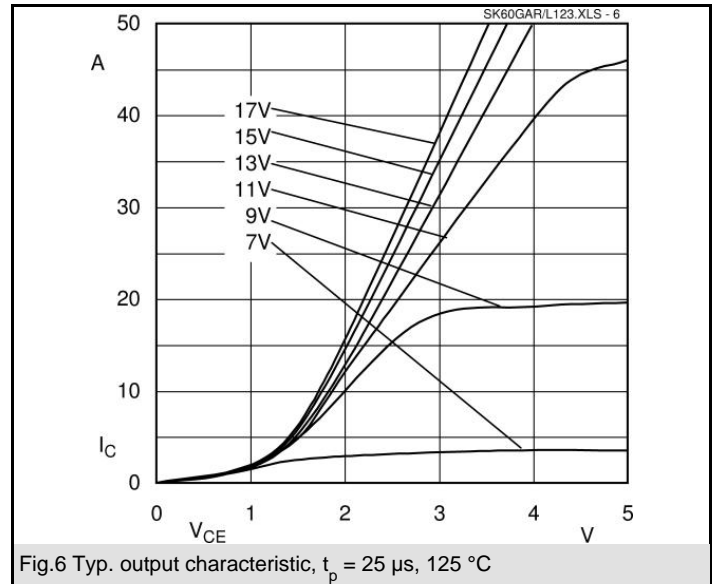
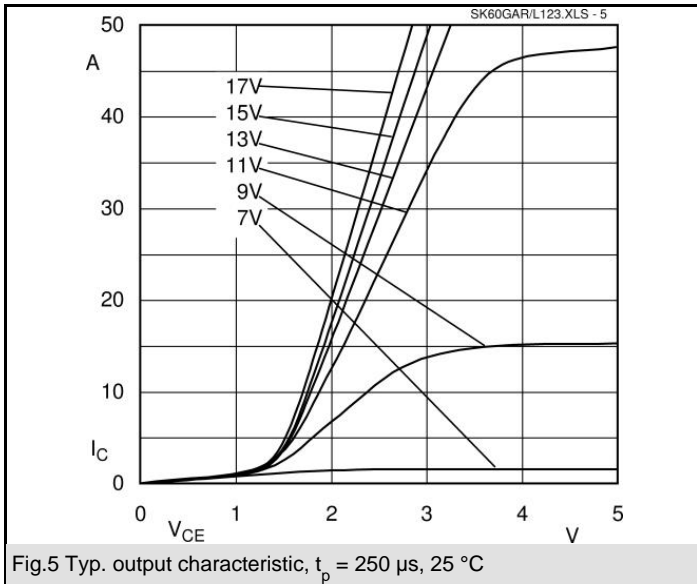

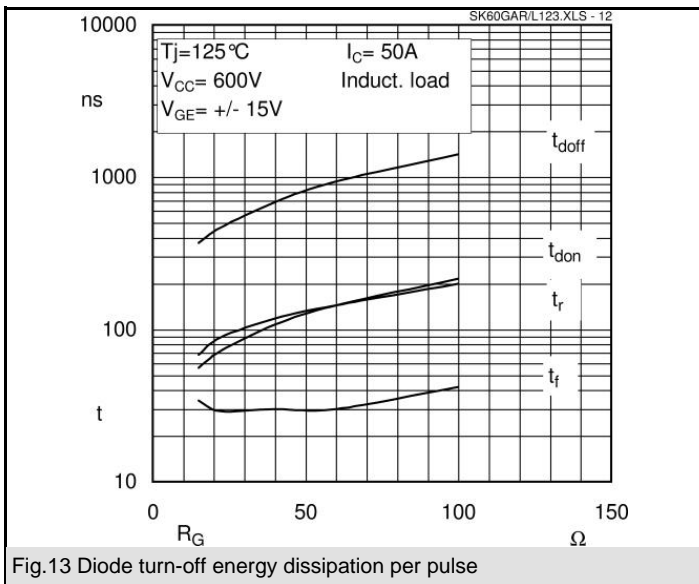
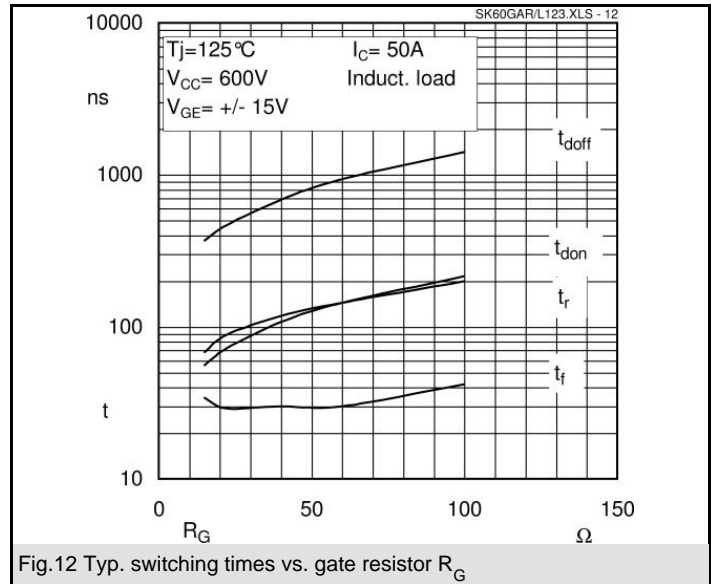
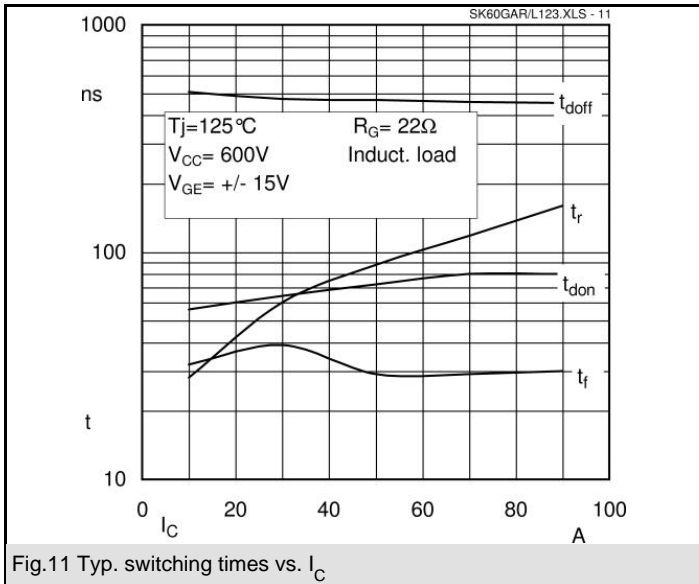

SK 60 GAL 123

UL Recognized
File no. E 63532

Dimensions in mm

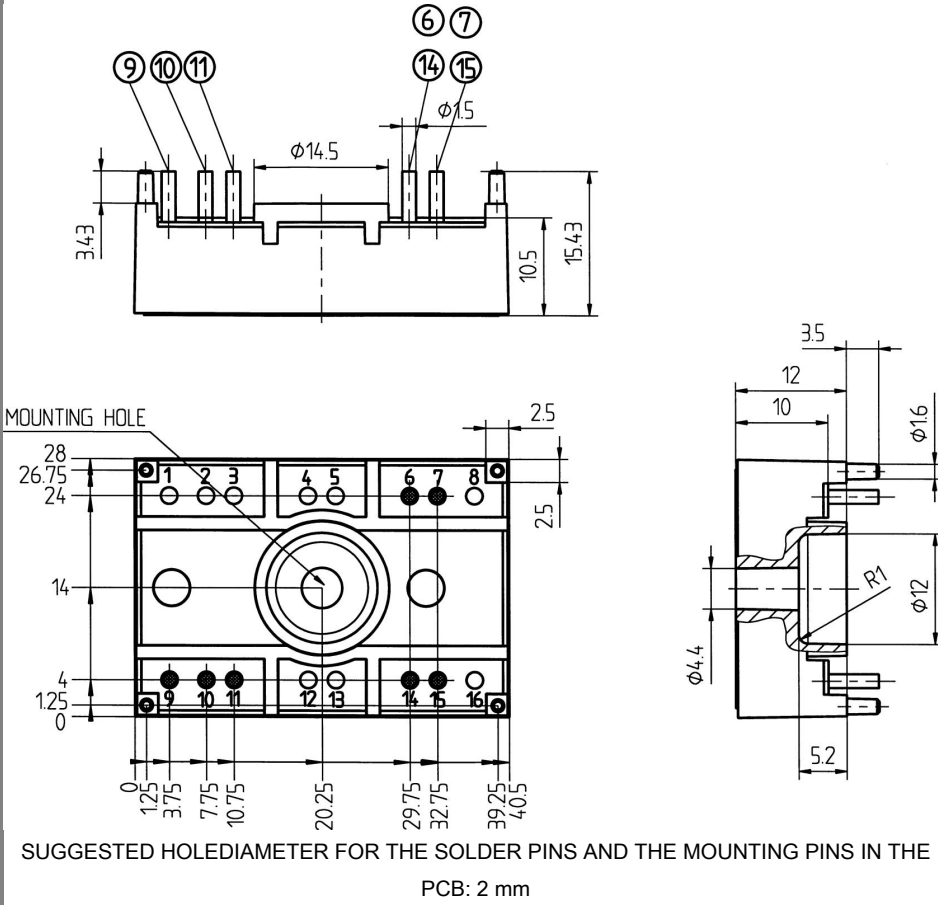

Case T18

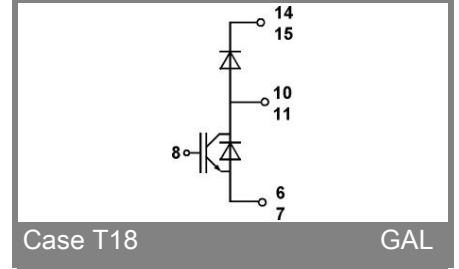

Case T18

GAL

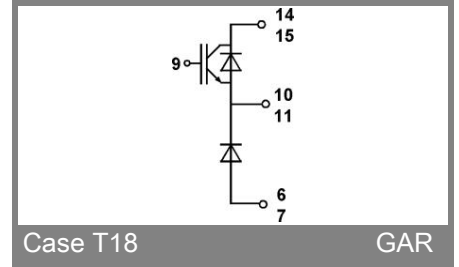

Case T18

GAR

This is an electrostatic discharge sensitive device (ESDS), international standard IEC 60747-1, Chapter IX.

This technical information specifies semiconductor devices but promises no characteristics. No warranty or guarantee expressed or implied is made regarding delivery, performance or suitability.