

SK 260MB10

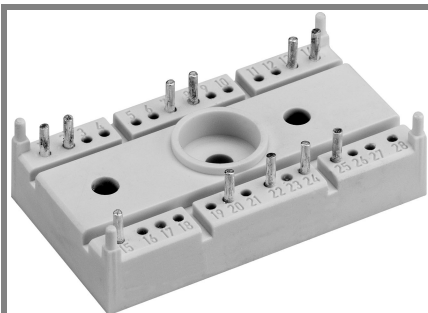

SEMITOP® 3

Mosfet Module

SK 260MB10

Preliminary Data

Features

- Compact design
- One screw mounting
- Heat transfer and isolation through direct copper bonded aluminium oxide ceramic (DCB)
- Trench technology
- Short internal connections and low inductance case

Typical Applications

- Low switched mode power supplies
- DC servo drives
- UPS

1) Maximum PCB temperature, at pins contact, 85°C

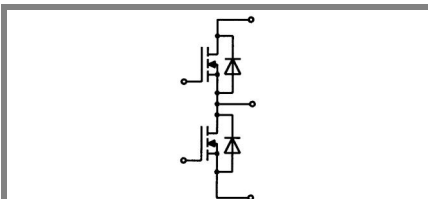

MB

Absolute Maximum Ratings		$T_s = 25\text{ °C}$, unless otherwise specified	
Symbol	Conditions	Values	Units
MOSFET			
V_{DSS}		100	V
V_{GSS}		± 20	V
I_D	$T_s = 25\text{ (80) °C}; 1$	230 (180)	A
I_{DM}	$t_p < 1\text{ ms}; T_s = 25\text{ (80) °C}; 1$	460 (360)	A
T_j		-40...+150	°C
Inverse diode			
$I_F = -I_D$	$T_s = 25\text{ (80) °C};$	230 (180)	A
$I_{FM} = -I_{DM}$	$t_p < 1\text{ ms}; T_s = 25\text{ (80) °C};$	460 (360)	A
T_j		-40...+150	°C
Freewheeling CAL diode			
$I_F = -I_D$	$T_s = \text{°C}$		A
T_j			°C
T_{stg}		-40 ... +125	°C
T_{sol}	Terminals, 10 s	260	°C
V_{isol}	a.c. 50 Hz, RMS, 1 min (1s)	2500 / 3000	V

Characteristics		$T_s = 25\text{ °C}$, unless otherwise specified			
Symbol	Conditions	min.	typ.	max.	Units
MOSFET					
$V_{(BR)DSS}$	$V_{GS} = 0\text{ V}; I_D = 0,25\text{ mA}$	$\geq V_{DSS}$			V
$V_{GS(th)}$	$V_{GS} = V_{DS}; I_D = 0,25\text{ mA}$	2,5	3,3		V
I_{DSS}	$V_{GS} = 0\text{ V}; V_{DS} = V_{DSS}; T_j = 25\text{ (125) °C}$			100 (500)	μA
I_{GSS}	$V_{GS} = 20\text{ V}; V_{DS} = 0\text{ V}$			100	nA
$R_{DS(on)}$	$I_D = 300\text{ A}; V_{GS} = 10\text{ V}; T_j = 25\text{ °C}$			2,5	m Ω
$R_{DS(on)}$	$I_D = 300\text{ A}; V_{GS} = 10\text{ V}; T_j = 125\text{ °C}$		3,5	4,5	m Ω
C_{CHC}	per MOSFET				pF
C_{iss}	under following conditions:		27,6		nF
C_{oss}	$V_{GS} = 0\text{ V}; V_{DS} = 25\text{ V}; f = 1\text{ MHz}$		2,9		nF
C_{rss}			2,8		nF
L_{DS}			2,2		nH
$t_{d(on)}$	under following conditions:		410		ns
t_r	$V_{DD} = 50\text{ V}; V_{GS} = 10\text{ V};$ $I_D = 300\text{ A}$		450		ns
$t_{d(off)}$	$R_G = 25\text{ }\Omega$		1490		ns
t_f			430		ns
$R_{th(j-s)}$	per MOSFET (per module)			0,45 (0,23)	K/W
Inverse diode					
V_{SD}	$I_F = 300\text{ A}; V_{GS} = 0\text{ V}; T_j = 25\text{ °C}$		0,76		V
I_{RRM}	under following conditions:		32		A
Q_{rr}	$I_F = 300\text{ A}; T_{vj} = 125\text{ °C}; R_G = 8,2\text{ }\Omega$		3		μC
t_{rr}	$V_R = 50\text{ A}; di/dt = 900\text{ A}/\mu\text{s}$				ns
Free-wheeling diode					
V_F	$I_F = \text{A}; V_{GS} = \text{V}$				V
I_{RRM}	under following conditions:				A
Q_{rr}	$I_F = \text{A}; T_{vj} = \text{°C}$				μC
t_{rr}	$V_r = \text{A}; di/dt = \text{A}/\mu\text{s}$				ns
Mechanical data					
M1	mounting torque			2,5	Nm
w			30		g
Case	SEMITOP® 3		T 24		

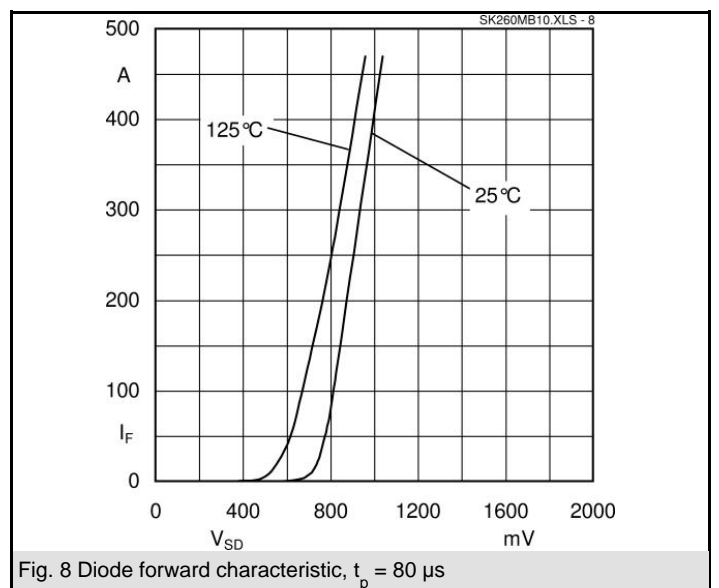
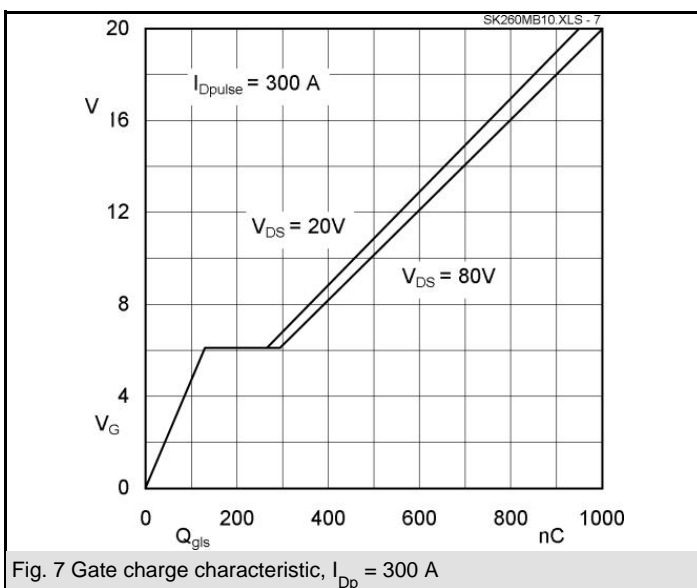
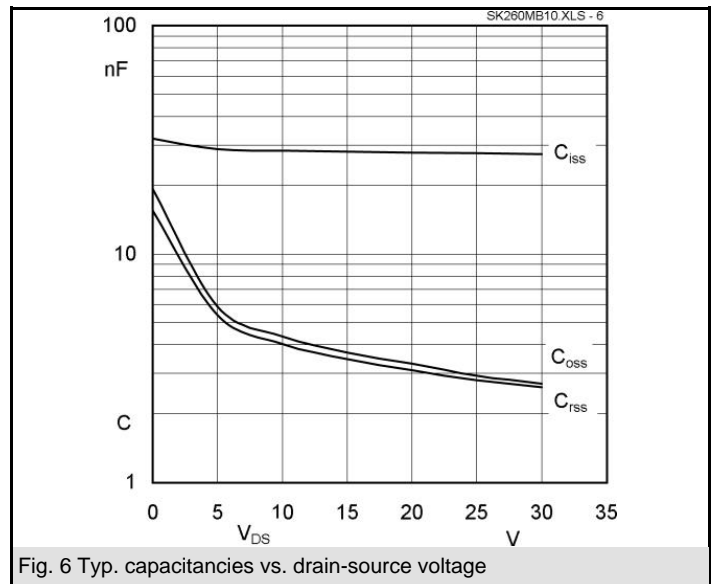
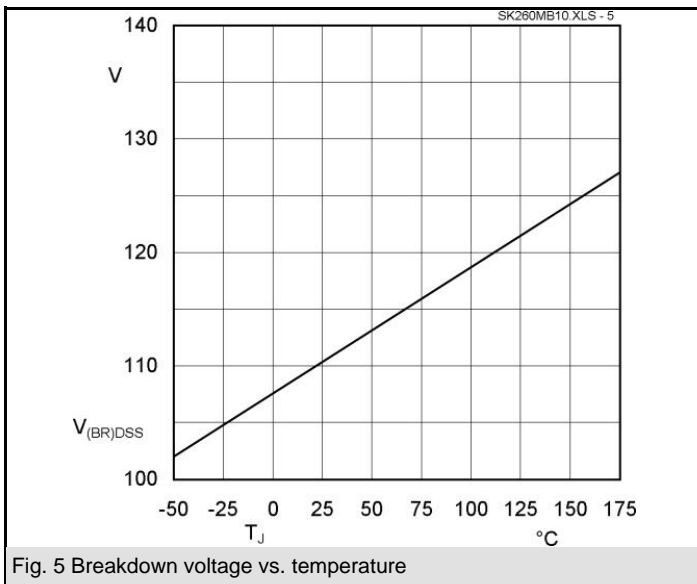
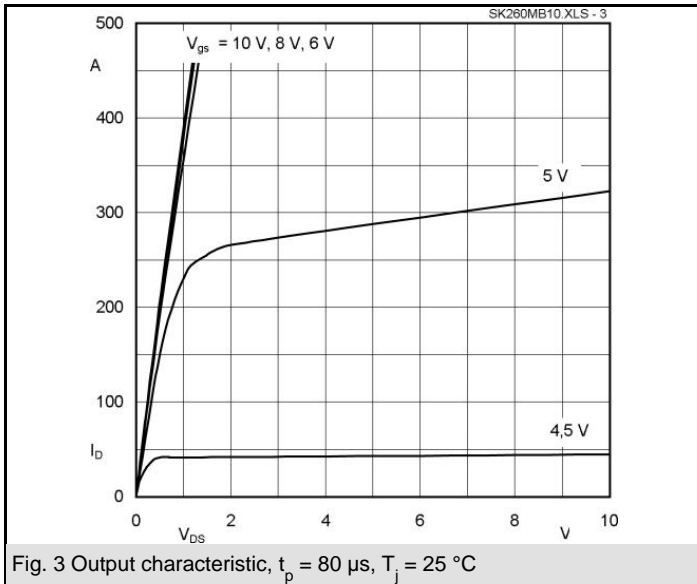

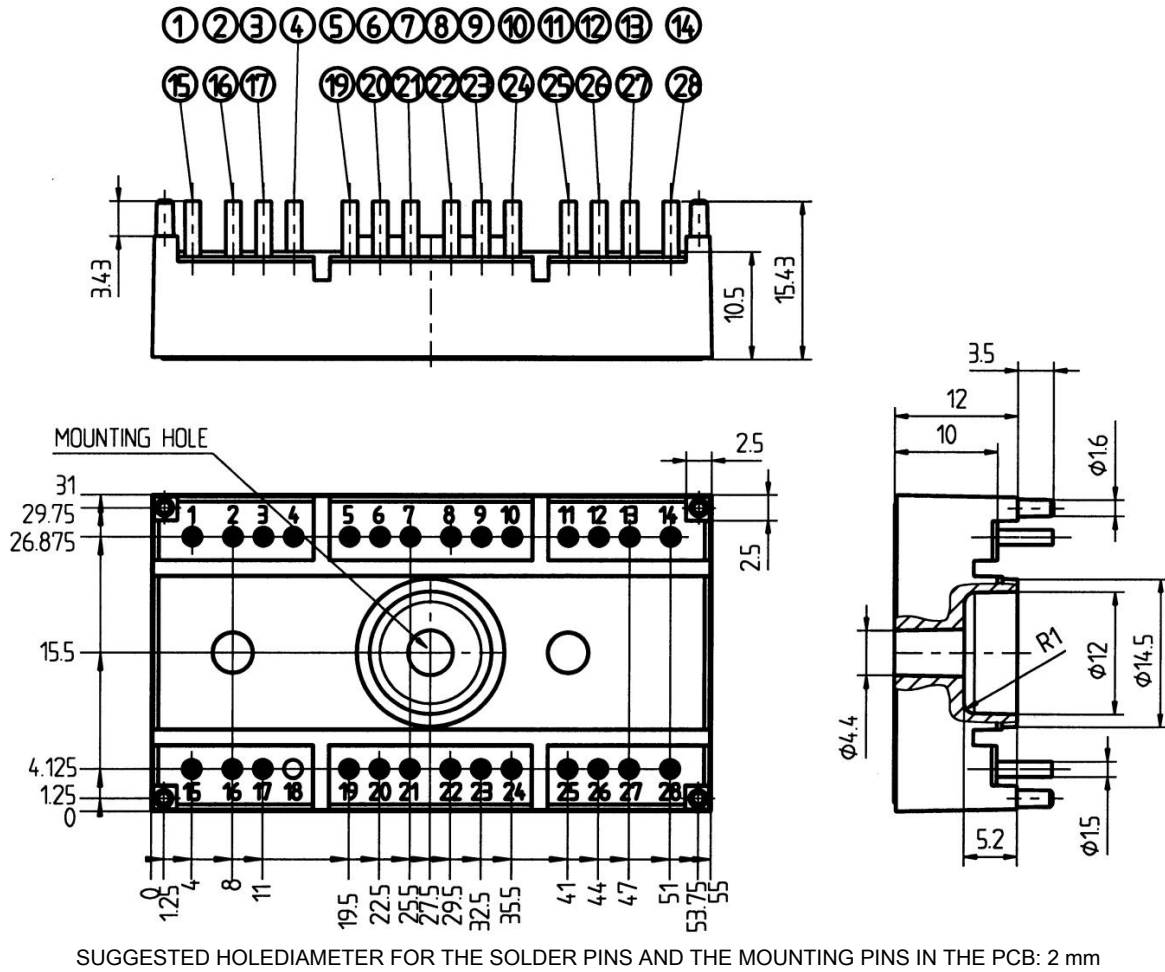

Case T24

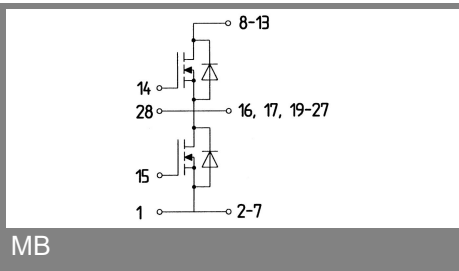

This is an electrostatic discharge sensitive device (ESDS), international standard IEC 60747-1, Chapter IX.

This technical information specifies semiconductor devices but promises no characteristics. No warranty or guarantee expressed or implied is made regarding delivery, performance or suitability.