



SF2045A

- **Designed for IF Applications**
- **Excellent Size-to-Performance Ratio**
- **Hermetic 13.3 x 6.5 mm Surface-mount Case**
- **Complies with Directive 2002/95/EC (RoHS)**



**140 MHz
SAW Filter**

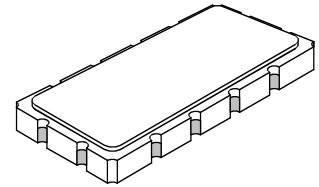

SM13365-12

Absolute Maximum Ratings

Rating	Value	Units
Maximum Incident Power in Passband	+10	dBm
Max. DC voltage between any 2 terminals	30	VDC
Storage Temperature Range	-40 to +85	°C
Suitable for lead-free soldering - Max. Soldering Profile	260°C for 30 s	

Electrical Characteristics

Characteristic	Sym	Notes	Min	Typ	Max	Units
Center Frequency (3dB points) at 25°C	f_C	1	139.60	140.000	140.40	MHz
Passband	Insertion Loss at f_C	IL		7.7	11	dB
	1 dB Passband	BW_1	8	9.8		MHz
	3 dB Passband	BW_3	10	10.8		
	Amplitude Ripple over 1 dB BW			0.4	0.8	dB _{P-P}
	Phase Linearity over 1 dB BW			2.7	8	° _{P-P}
Group Delay Variation over 1 dB BW	GDV			50	100	ns _{P-P}
Absolute Group Delay				1.057		µsec
Rejection	35 dB BW			13.9	15	MHz
	10 - 120 MHz		40	52	dB	
	120 - 130 MHz		40	47		
	150 - 1000 MHz		40	45		
Operating Temperature Range	T_A	1	-40	25	85	°C
Frequency Temperature Coefficient	FTC			-94		ppm/°C

Impedance Matching to 50Ω Unbalanced	External L-C
Case Style	SM13365-12 13.3 x 6.5 mm Nominal Footprint
Lid Symbolization (YY = year, WW = week)	RFM SF2045A YYWW

Notes:

1. Unless noted otherwise, all specifications apply over the operating temperature range with filter soldered to the specified demonstration board with impedance matching to 50 Ω and measured with 50 Ω network analyzer.
2. The design, manufacturing process, and specifications of this filter are subject to change.
3. Either Port 1 or Port 2 may be used for either input or output in the design. However, impedances and impedance matching may vary between Port 1 and Port 2, so that the filter must always be installed in one direction per the circuit design.
4. US and international patents may apply.
5. Electrostatic Sensitive Device. Observe precautions for handling. 

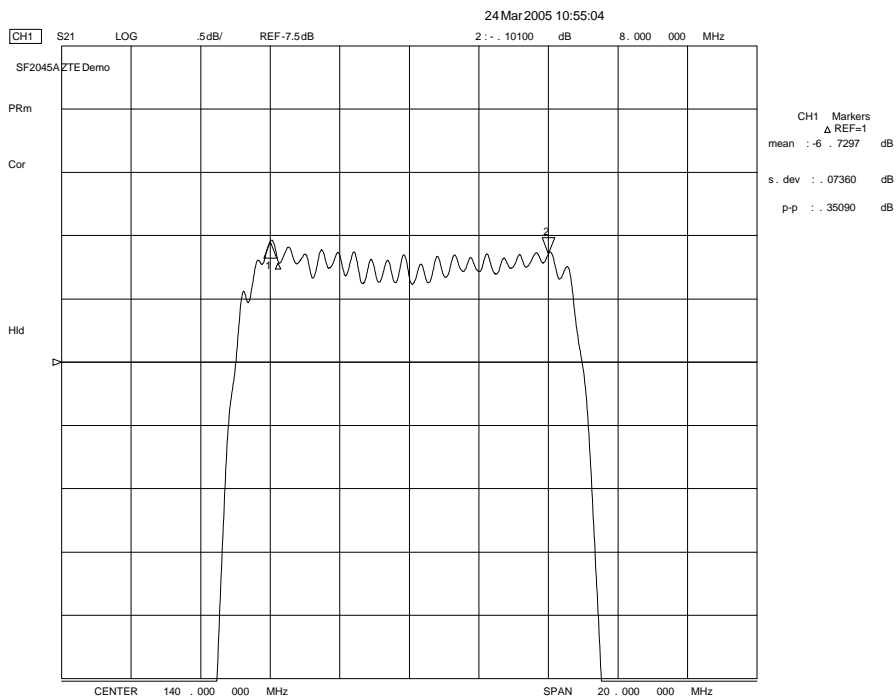
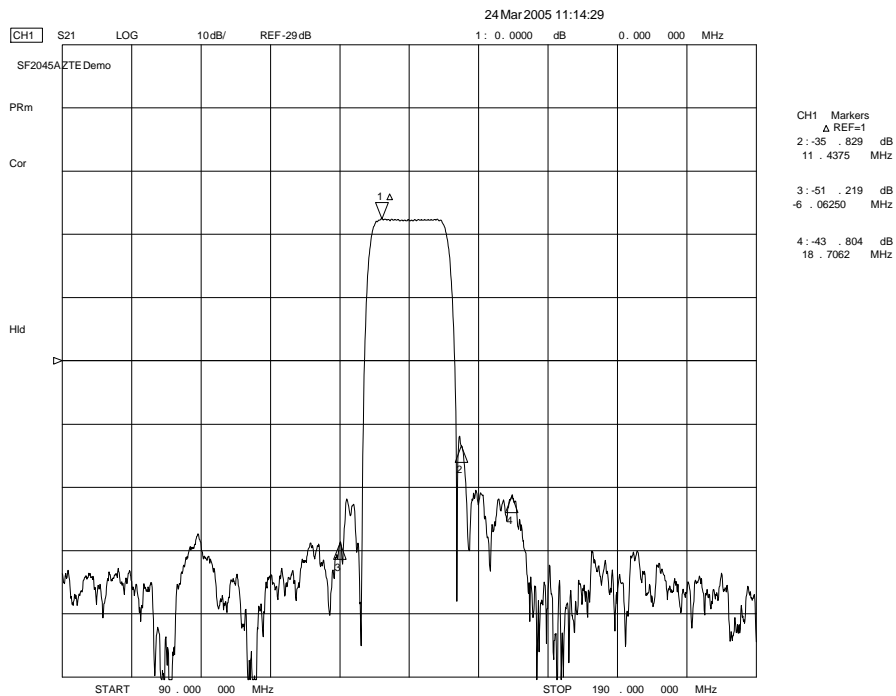

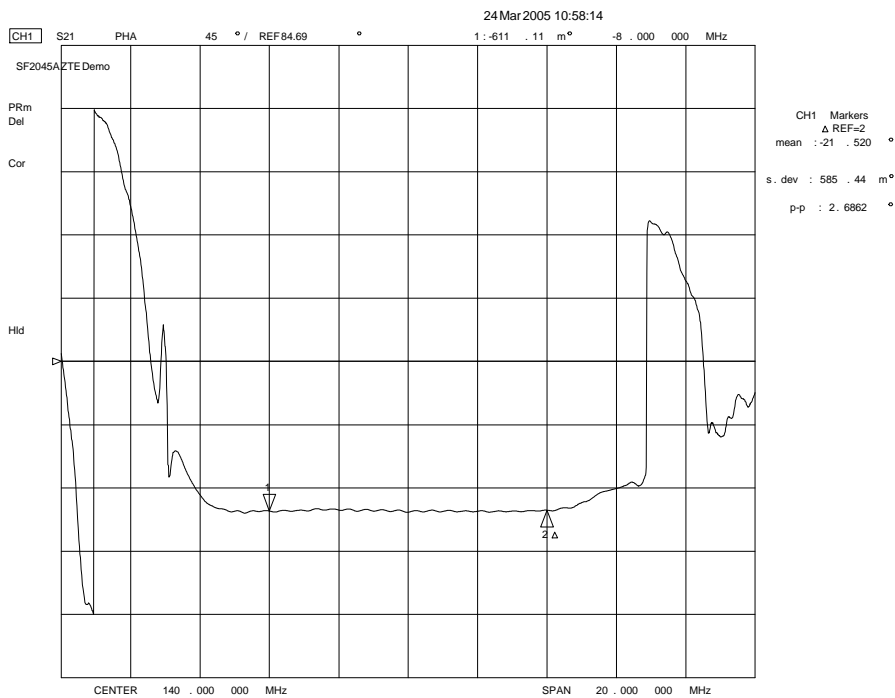
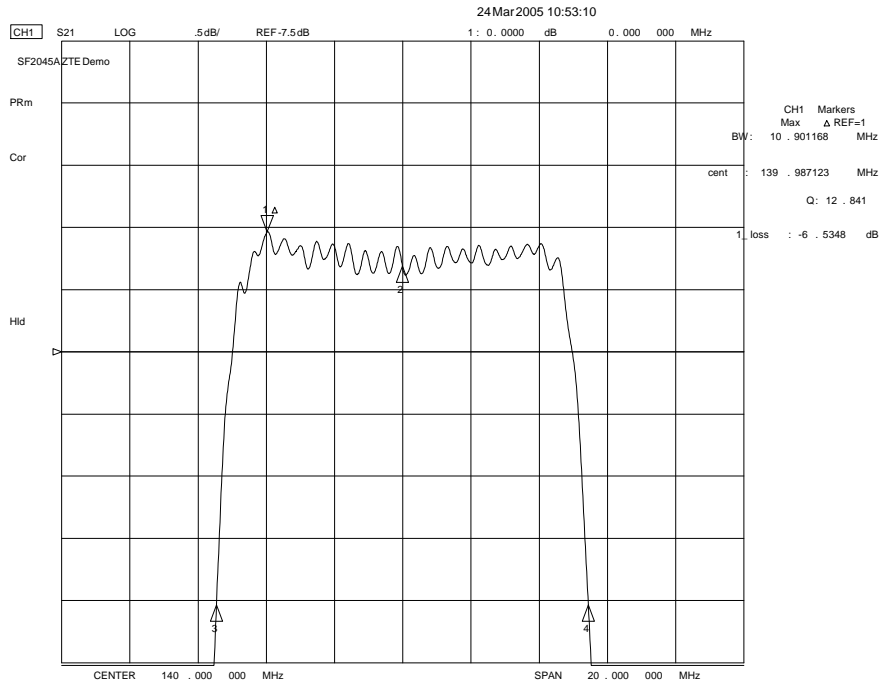

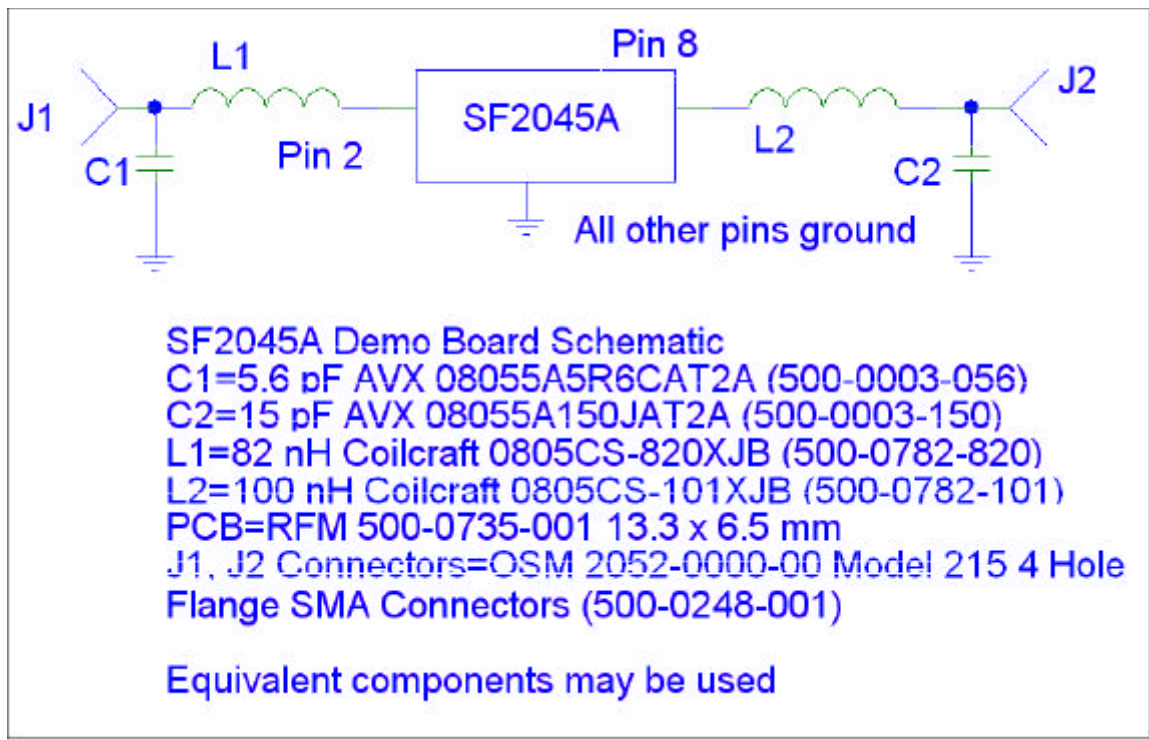
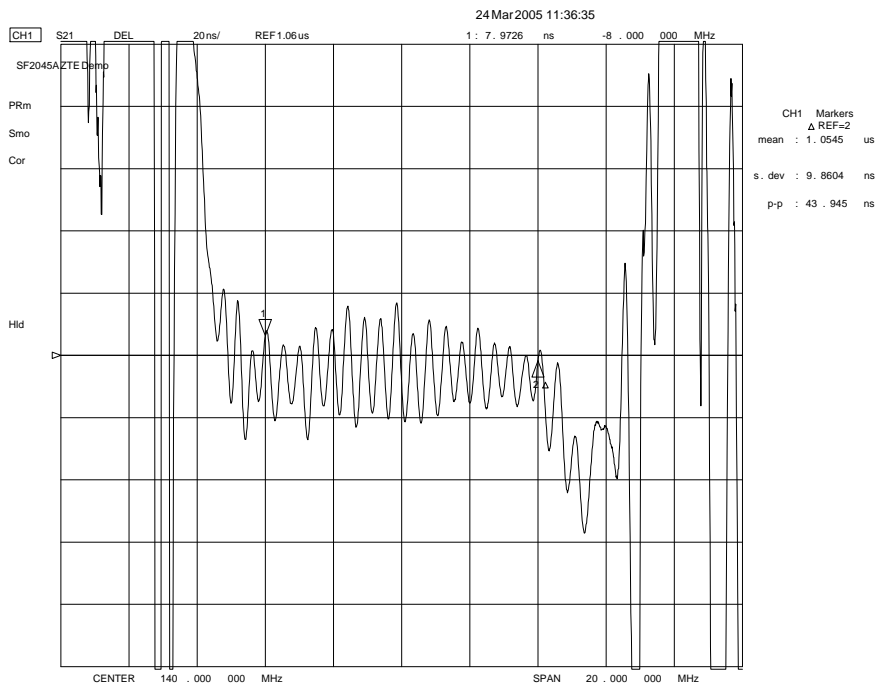

SM13365-12 Case

12-Terminal Ceramic Surface-Mount Case
13.3 x 6.5 mm Nominal Footprint

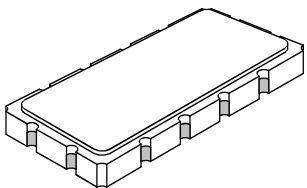

Dimension	Case Dimensions					
	mm			Inches		
	Min	Nom	Max	Min	Nom	Max
A	13.08	13.31	13.60	0.515	0.524	0.535
B	6.27	6.50	6.80	0.247	0.256	0.268
C		1.91	2.00		0.075	0.079
D		1.50			0.059	
E		0.79			0.031	
H		1.0			0.039	
P		2.54			0.100	

Materials	
Solder Pad Termination	Au plating 30 - 60 unches (76.2-152 uM) over 80-200 unches (203-508 uM) Ni.
Lid	Fe-Ni-Co Alloy Electroless Nickel Plate (8-11% Phosphorus) 100-200 unches Thick
Body	Al ₂ O ₃ Ceramic
Pb Free	

Electrical Connections		
Connection		Terminals
Port 1	Input	2
	Ground	3
Port 2	Output	8
	Ground	9
	Ground	All others

See Note 3 on Data Sheet

- pin 1 indicator
- ⋯ mark for pin 1 on underside of package
- YY year code
- WW week code
- #### lot code

