

PACKAGE DIMENSIONS

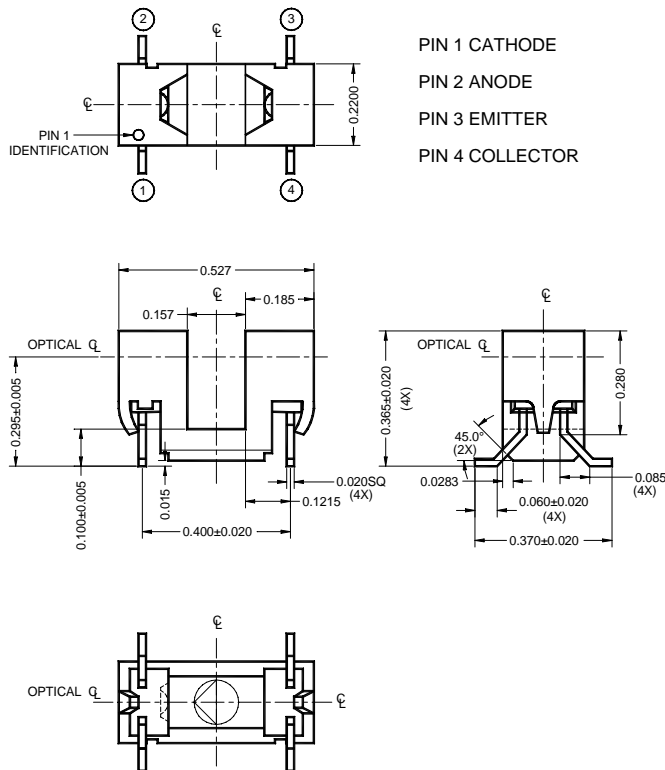

PIN 1 CATHODE
PIN 2 ANODE
PIN 3 EMITTER
PIN 4 COLLECTOR

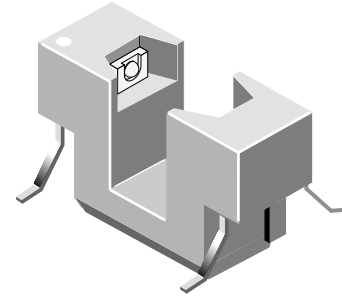

FEATURES

- No contact switching
- 4 mm wide slot
- Leads formed for surface mounting
- Housing material resistant to high temperatures
- Daylight filter on sensor
- Transistor Output
- Tape & Reel Option: .TR (See Tape & Reel Dimensions)

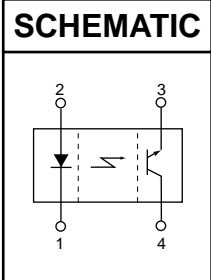

NOTES:

1. Dimensions for all drawings are in inches.
2. Tolerance of $\pm .010$ on all non-nominal dimensions unless otherwise specified.
3. All leads are coplanar within .006".
4. Housing material is electrically conductive.

NOTES (Applies to Max Ratings and Characteristics Tables.)

1. Derate power dissipation linearly 1.67 mW/°C above 25°C.
2. RMA flux is recommended.
3. Methanol or isopropyl alcohols are recommended as cleaning agents.

ABSOLUTE MAXIMUM RATINGS ($T_A = 25^\circ\text{C}$ unless otherwise specified)

Parameter	Symbol	Rating	Units
Operating Temperature	T_{OPR}	-40 to +100	°C
Storage Temperature	T_{STG}	-40 to +100	°C
Soldering Temperature (Flow) ^(2,3)	T_{SOL-F}		
Preheating Stage for 60 sec		183	°C
Reflow Stage for 5 sec		230	°C
Rate of Temperature Rise		3 to 10	°C/S
EMITTER			
Continuous Forward Current	I_F	50	mA
Reverse Voltage	V_R	5	V
Power Dissipation ⁽¹⁾	P_D	100	mW
SENSOR			
Collector-Emitter Voltage	V_{CEO}	30	V
Emitter-Collector Voltage	V_{ECO}	4	V
Power Dissipation ⁽¹⁾	P_D	100	mW

ELECTRICAL / OPTICAL CHARACTERISTICS ($T_A = 25^\circ\text{C}$)						
PARAMETER	TEST CONDITIONS	SYMBOL	MIN	TYP	MAX	UNITS
EMITTER						
Forward Voltage	$I_F = 20\text{ mA}$	V_F	—	—	1.7	V
Reverse Current	$V_R = 5\text{ V}$	I_R	—	—	100	μA
Peak Emission Wavelength	$I_F = 20\text{ mA}$	λ_{PE}	—	940	—	nm
SENSOR						
Collector-Emitter Breakdown	$I_C = 1\text{ mA}$	BV_{CEO}	30	—	—	V
Emitter-Collector Breakdown	$I_E = 0.1\text{ mA}$	BV_{ECO}	5	—	—	V
Dark Current	$V_{CE} = 10\text{ V}, I_F = 0\text{ mA}$	I_D	—	—	100	nA
COUPLED						
Collector Current	$I_F = 20\text{ mA}, V_{CE} = 5\text{ V}$	$I_{C(ON)}$	2.0	—	—	mA
Collector Emitter Saturation Voltage	$I_F = 20\text{ mA}, I_C = 0.5\text{ mA}$	$V_{CE(SAT)}$	—	—	0.4	V
Rise Time	$V_{CE} = 5\text{ V}, R_L = 100\ \Omega$	t_r	—	8	—	μs
Fall Time	$I_C = 5\text{ mA}$	t_f	—	50	—	μs

Fig. 1 Forward Voltage vs. Ambient Temperature

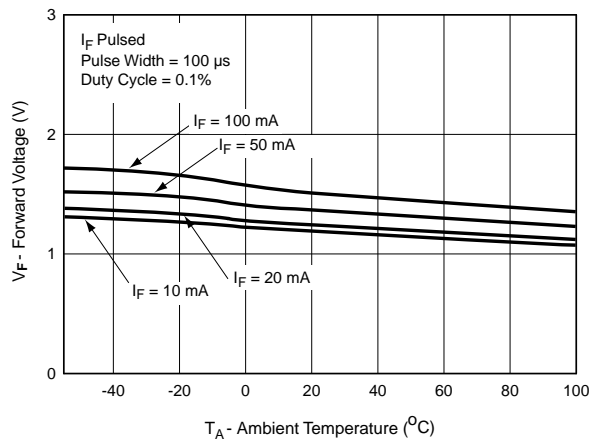

Fig. 2 Forward Current vs. Forward Voltage

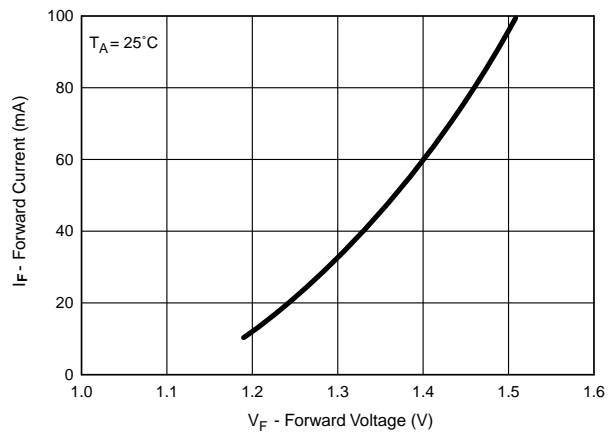

Fig. 3 Collector Emitter Dark Current (Normalized) vs. Ambient Temperature

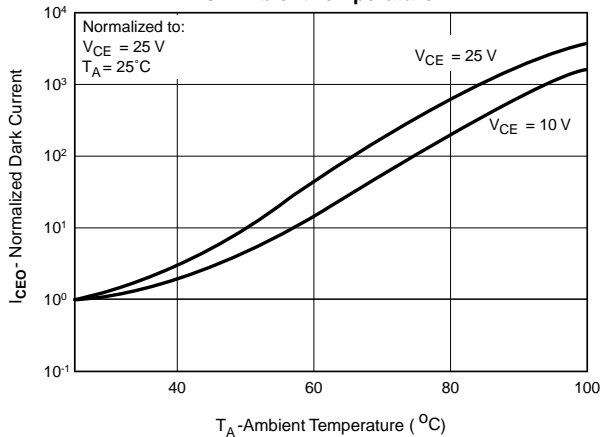

Fig. 4 Rise and Fall Time vs. Load Resistance

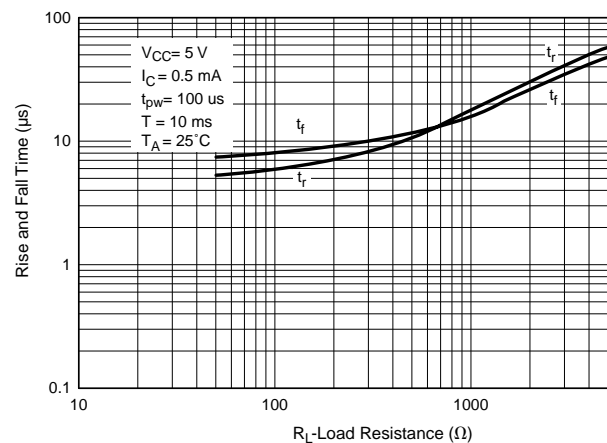

Fig. 5 Collector Current vs. Forward Current

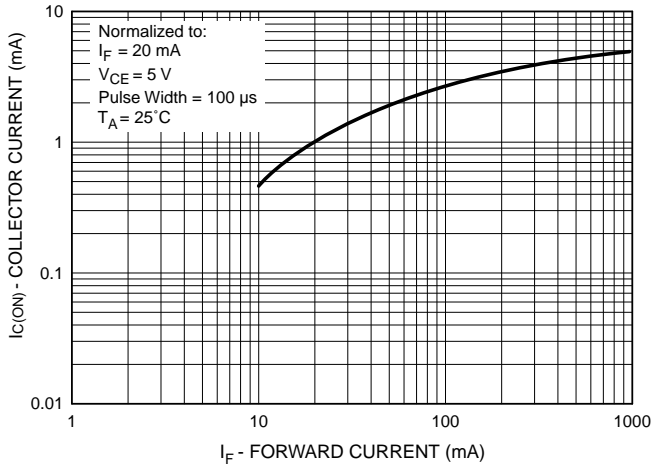

Fig. 6 Collector Current vs. Collector Emitter Voltage

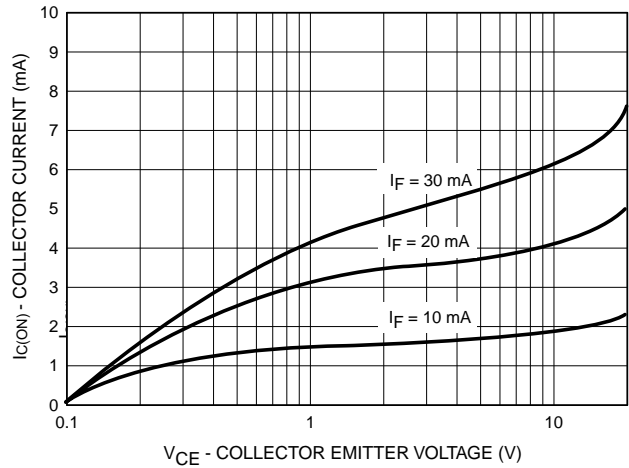

Fig. 7 Collector Current vs. Ambient Temperature

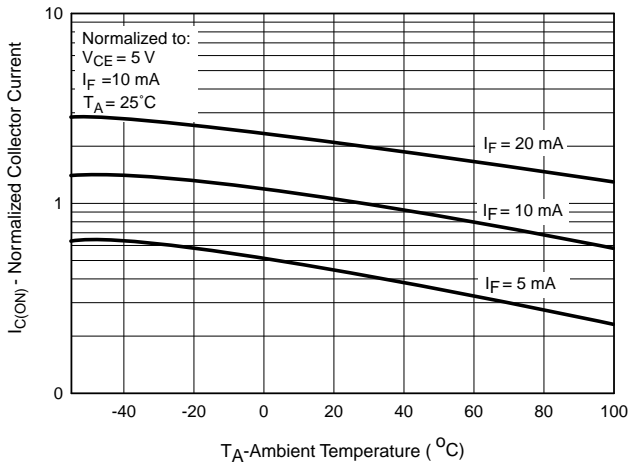

Fig. 8 Collector Current vs. Shield Distance

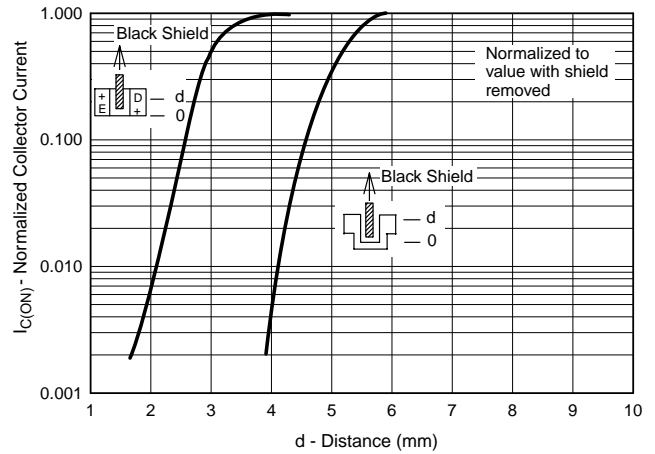
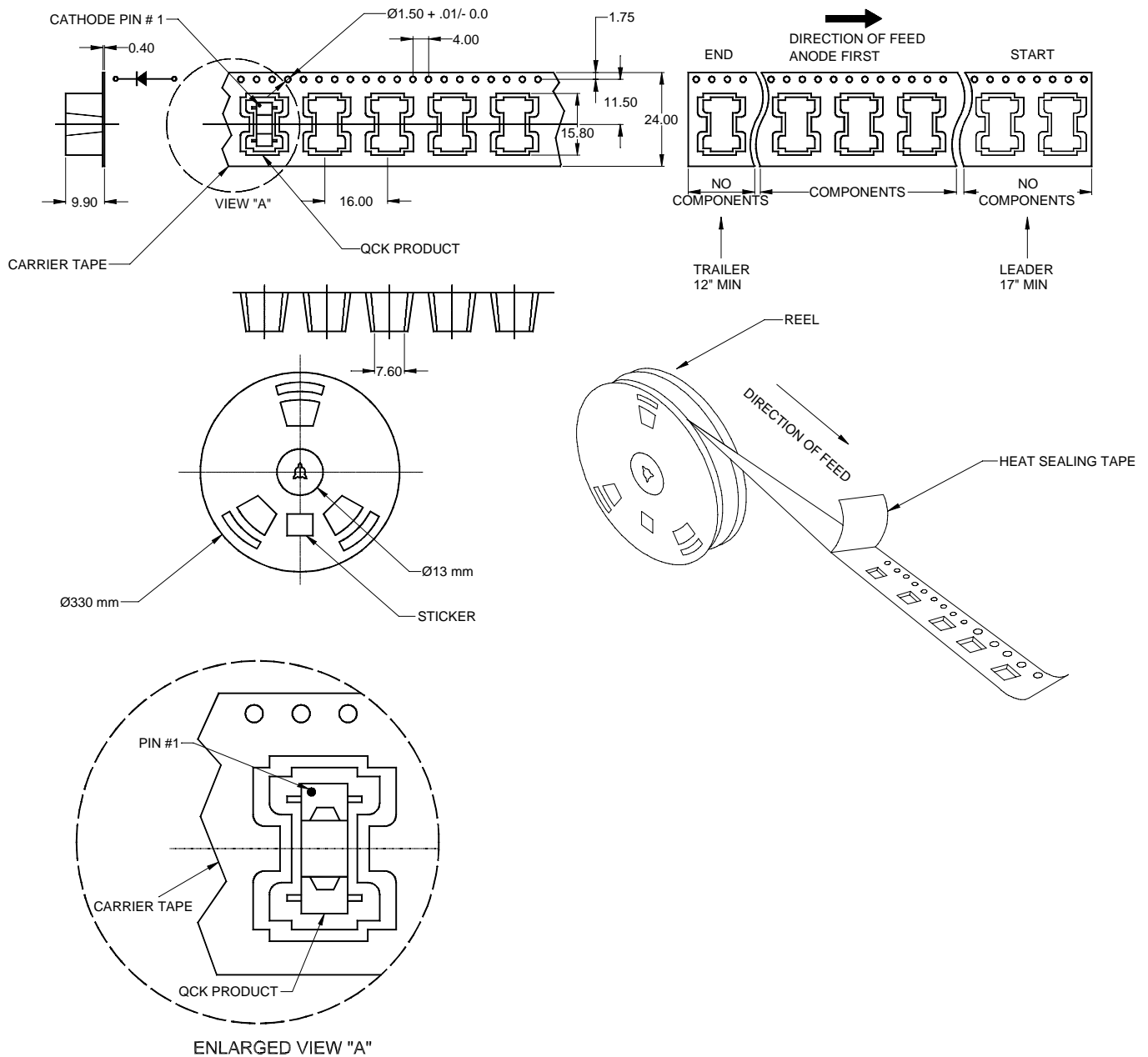

Fig. 9 Power Dissipation vs. Ambient Temperature (TBD)

TAPE & REEL DIMENSIONS



NOTES:

1. QUANTITY PER REEL: 300 UNITS.
2. CARRIER TAPE MATERIAL: HIGH IMPACT POLYSTERINE (CONDUCTIVE BLACK).
3. REEL MATERIAL: HIGH IMPACT STYRENIC ALLOY.
4. TAPE PLACED ON TOP OF UNIT TO AID PICK AND PLACE MACHINE.
5. ALL DIMENSIONS ARE IN MILLIMETERS (UNLESS OTHERWISE SPECIFIED).

DISCLAIMER

FAIRCHILD SEMICONDUCTOR RESERVES THE RIGHT TO MAKE CHANGES WITHOUT FURTHER NOTICE TO ANY PRODUCTS HEREIN TO IMPROVE RELIABILITY, FUNCTION OR DESIGN. FAIRCHILD DOES NOT ASSUME ANY LIABILITY ARISING OUT OF THE APPLICATION OR USE OF ANY PRODUCT OR CIRCUIT DESCRIBED HEREIN; NEITHER DOES IT CONVEY ANY LICENSE UNDER ITS PATENT RIGHTS, NOR THE RIGHTS OF OTHERS.

LIFE SUPPORT POLICY

FAIRCHILD'S PRODUCTS ARE NOT AUTHORIZED FOR USE AS CRITICAL COMPONENTS IN LIFE SUPPORT DEVICES OR SYSTEMS WITHOUT THE EXPRESS WRITTEN APPROVAL OF THE PRESIDENT OF FAIRCHILD SEMICONDUCTOR CORPORATION. As used herein:

1. Life support devices or systems are devices or systems which, (a) are intended for surgical implant into the body, or (b) support or sustain life, and (c) whose failure to perform when properly used in accordance with instructions for use provided in the labeling, can be reasonably expected to result in a significant injury of the user.
2. A critical component in any component of a life support device or system whose failure to perform can be reasonably expected to cause the failure of the life support device or system, or to affect its safety or effectiveness.