

# Cree® Mini-Dorado LED

## Model # LD-300CPG2-C5

### Data Sheet

3 x 3 mm, QFN-type, high-power, green LED with water-clear-compound encapsulated

#### Applications

- High-luminous-flux output for illumination
- Exposed-pad design for excellent heat transfer
- Designed for high-current operation
- Reflow soldering applicable

#### Absolute Maximum Ratings ( $T_A = 25^\circ\text{C}$ )

Items	Symbol	Absolute Maximum Rating	Unit
Forward Current	$I_F$	100	mA
Peak Forward Current <sup>Note 1</sup>	$I_{FP}$	150	mA
Reverse Voltage	$V_R$	5	V
Power Dissipation	$P_D$	0.48	W
Operation Temperature	$T_{opr}$	-40 ~ +85	°C
Storage Temperature	$T_{stg}$	-40 ~ +85	°C
Junction Temperature	$T_J$	110	°C
Junction-to-Ambient <sup>Note 2</sup>	$\theta_{JA}$	135	°C/W
Junction-to-Case <sup>Note 2</sup>	$\theta_{JC}$	70	°C/W

#### Notes:

1. Pulse width  $\leq 0.1$  msec, duty  $\leq 1/10$ .
2. Rth test condition: mounted on 1.7 mm, Al-based PCB in size of 12 x 12 mm

#### Typical Electrical & Optical Characteristics at $T_A = 25^\circ\text{C}$ (on metal core PCV) <sup>Note</sup>

Characteristics	Symbol	Condition	Unit	Minimum	Typical	Maximum
Forward Voltage	$V_F$	$I_F = 100$ mA	V		4.0	4.8
Reverse Current	$I_R$	$V_R = 5$ V	$\mu\text{A}$			10
Dominant Wavelength	$\lambda_D$	$I_F = 100$ mA	nm	510	525	535
Luminous Flux	lumen	$I_F = 100$ mA	lm	3	5	
50% Power Angle	$2\theta_{1/2H-H}$	$I_F = 100$ mA	°C		125	
	$2\theta_{1/2V-V}$	$I_F = 100$ mA	°C		115	

Note: A metal core PCB has an effective heat-transmission substrate (thickness of 1.7 mm, Al-based PCB in 12 x 12 mm,  $\theta_{JC} < 50^\circ\text{C/W}$  should suffice).

**Standard Bins for LD-300CPG2-C5 ( $I_f = 100 \text{ mA}$ )**

Lamps are sorted to luminous flux ( $\text{lm}$ ),  $V_f$  and dominant wavelength ( $\lambda_D$ ) bins shown.

Orders for LD-300CPG2-C5 may be filled with any or all bins contained as below.

All luminous flux ( $\text{lm}$ ),  $V_f$  and dominant wavelength ( $\lambda_D$ ) values shown and specified are at  $I_f = 100 \text{ mA}$ .

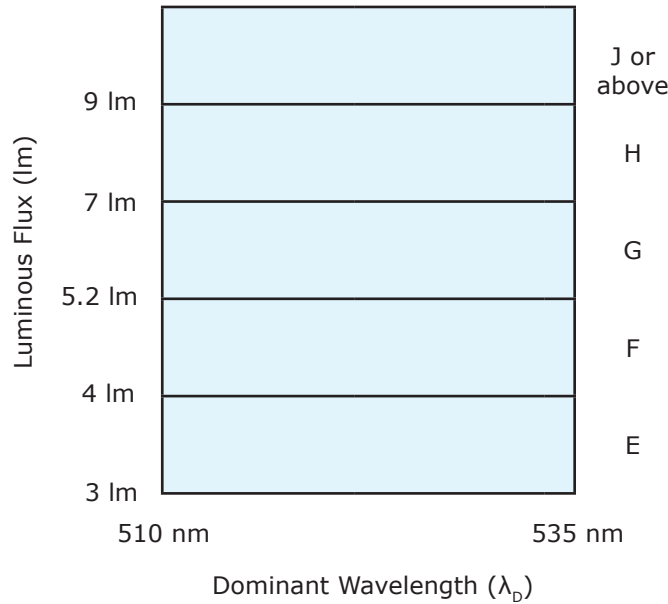

**Forward Voltage ( $V_f$ )**

Rank	V5a	V5b	V6a	V6b	V7a	V7b	V8a	V8b
Voltage	3.2-3.4 V	3.4-3.6 V	3.6-3.8 V	3.8-4.0 V	4.0-4.2 V	4.2-4.4 V	4.4-4.6 V	4.6-4.8 V

**Important Notes:**

1. All ranks will be included per delivery; rank ratio will be based on the dice distribution.
2. Pb content <1000 ppm.
3. Tolerance of measurement of luminous flux is  $\pm 10\%$ .
4. Tolerance of measurement of dominant wavelength is  $\pm 1 \text{ nm}$ .
5. Tolerance of measurement of  $V_f$  is  $\pm 0.01 \text{ V}$ .
6. Packaging methods are available for selection; please refer to the "Cree LED Lamp Packaging Standard" document.
7. Please refer to the "Cree LED Lamp Reliability Test Standards" document for reliability test conditions.
8. Please refer to the "Cree LED Lamp Soldering & Handling" document for information about how to use this LED product safely.

**Graphs**

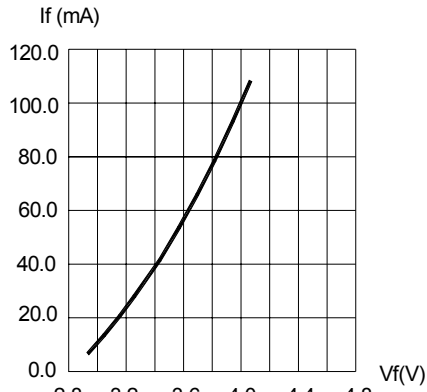

FIG.1 FORWARD CURRENT VS. FORWARD VOLTAGE.

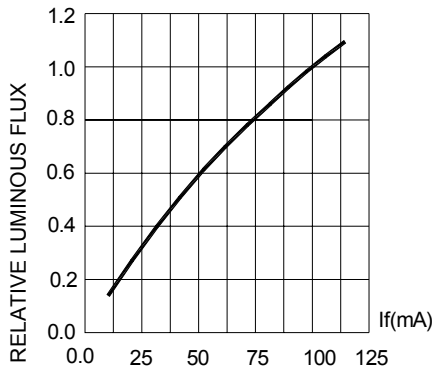

FIG.2 FORWARD CURRENT.

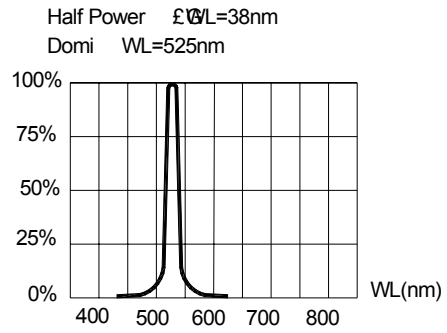

FIG.3 RELATIVE LUMINOUS FLUX VS. WAVELENGTH.

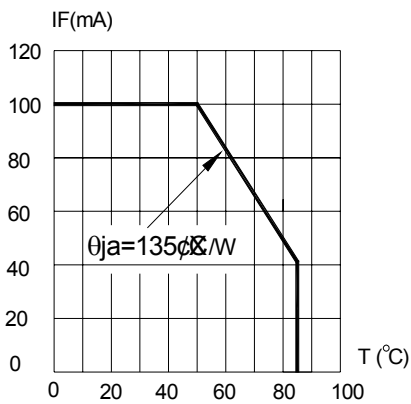

FIG.4 MAXIMUM FORWARD DC CURRENT VS TEMPERATURE. DERATING BASED ON  $T_{jmax}=110^\circ\text{C}$

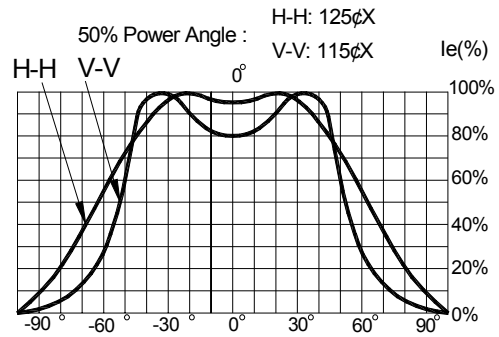
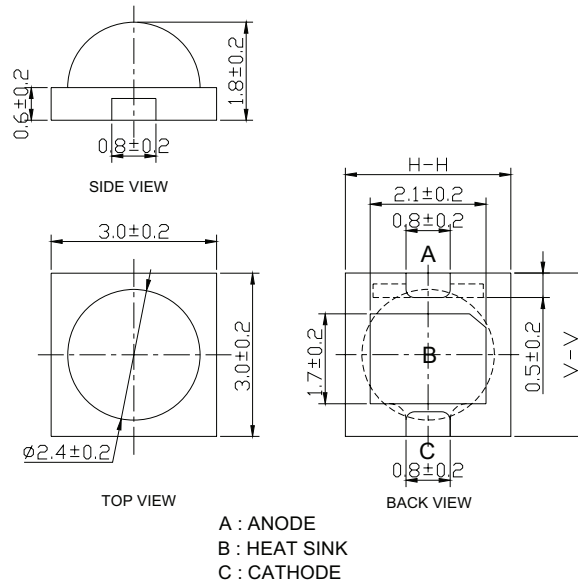

FIG.5 FAR FIELD PATTERN

## Mechanical Dimensions

All dimensions are in mm.



## Notes

### RoHS Compliance

The levels of environmentally sensitive, persistent biologically toxic (PBT), persistent organic pollutants (POP), or otherwise restricted materials in this product are below the maximum concentration values (also referred to as the threshold limits) permitted for such substances, or are used in an exempted application, in accordance with EU Directive 2002/95/EC on the restriction of the use of certain hazardous substances in electrical and electronic equipment (RoHS), as amended through April 21, 2006.

### Vision Advisory Claim

Users should be cautioned not to stare at the light of this LED product. The bright light can damage the eye.

## Kit Number System

Cree LED lamps are tested and sorted into performance bins. A bin is specified by ranges of color, forward voltage, and brightness. Sorted LEDs are packaged for shipping in various convenient options. Please refer to the "Cree LED Lamp Packaging Standard" document for more information about shipping and packaging options.

Cree LEDs are sold by order codes in combinations of bins called kits. Order codes are configured in the following manner:

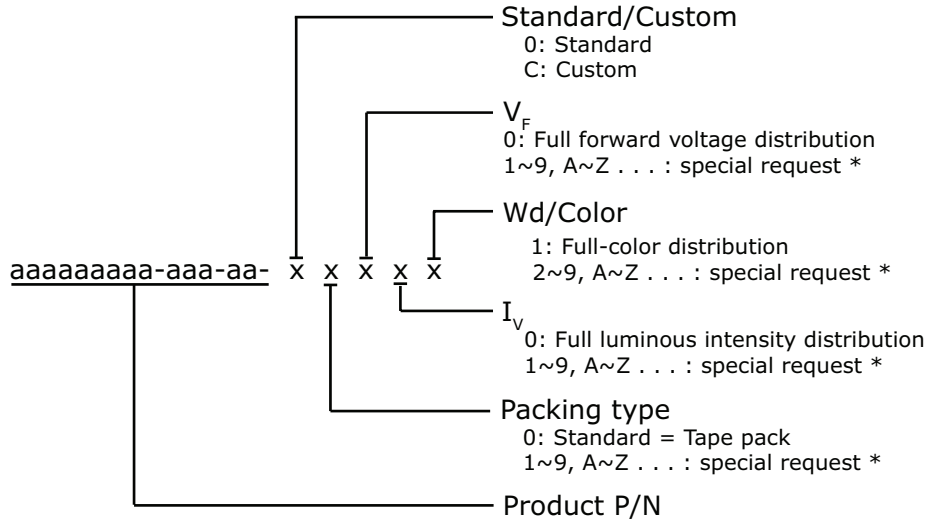

\* Contact your Cree sales representative for ordering information.

## Standard Available Kits\*

Kit Number	Description
LD-300CPG2-C5-00001	MD 125 Green 525nm, FULL RANK, Tape and Reel

\* Please contact your Cree representative about the availability of non-standard kits.