

150mA POWER LOW DROPOUT REGULATOR

The KR15SXXXM is an efficient linear voltage regulator with very low dropout voltage(Typically 10mV at light loads and 165mV at 175mA)

The KR15SXXXM can be enabled, or shut down by a CMOS or TTL compatible signal. When disabled, power consumption drops nearly to zero. Dropout ground current is minimized to help prolong battery life. Other key features include reversed battery protection, current limiting, over temperature shutdown, and low noise performance with an ultra-low-noise option

FEATURES

- High Output Voltage Accuracy : 1%
- Low Quiescent Current. : $I_{Q(OFF)} = 3\mu A$
- Very Low Ground Current : $350\mu A (I_{OUT} = 50mA)$
- Low Dropout Voltage : 175mV($I_{OUT}=150mA$)
- Built-in ON/OFF control Terminal
- Built -in Over Current , Over Heat Protection Function
- Reverse-Battery Protection

APPLICATIONS

- Laptop, notebook, and palmtop computers
- Cellular telephones and battery-powered equipment
- Consumer and personal electronics
- PC Card VCC and VPP regulation and switching
- SMPS post-regulator/dc-to-dc modules
- High-efficiency linear power supplies

LINE-UP

V _{OUT} (V)	TSV	
	ITEM	MARKING
1.8	KR15S018M	A18
2.5	KR15S025M	A25
2.6	KR15S026M	A26
2.7	KR15S027M	A27
2.8	KR15S028M	A28
2.85	KR15S285M	A2J
2.9	KR15S029M	A29
3.0	KR15S030M	A30
3.1	KR15S031M	A31
3.3	KR15S033M	A33

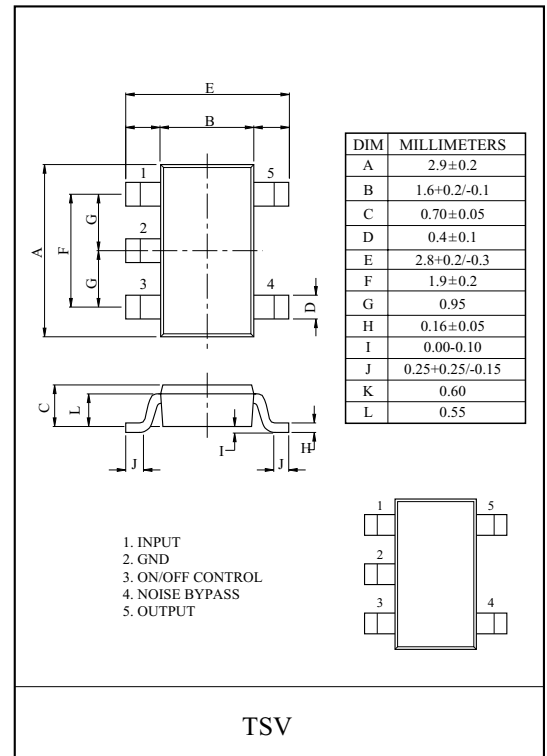

KR15S018M~KR15S033M

MARKING

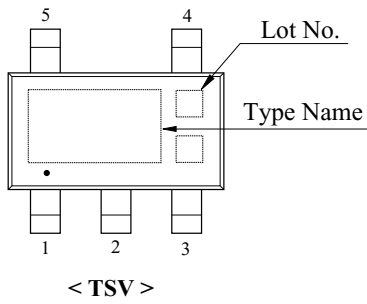

PIN DESCRIPTIONS

PIN NO.	NAME	FUNCTION
1	V_{IN}	Supply Input
2	GND	Ground
3	ON/OFF Control	Enable/Shutdown (Input): CMOS compatible input. Logic high = Enable, Logic low or open = Shutdown
4	Bypass	Reference Bypass : Connect external 470pF capacitor to GND to reduce output noise. May be left open
5	V_{OUT}	Regulator Output

Fig. 1 BLOCK DIAGRAM

Fig. 2 TEST CIRCUIT / APPLICATION CIRCUIT

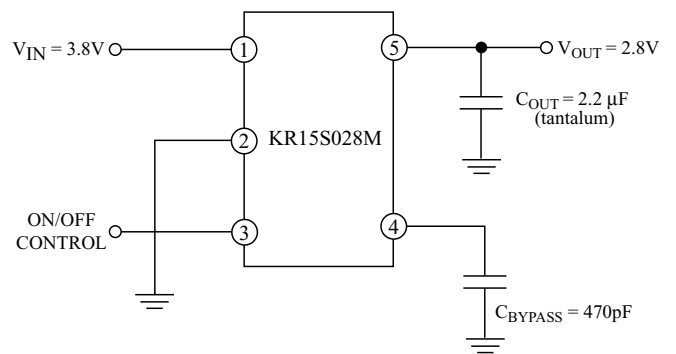
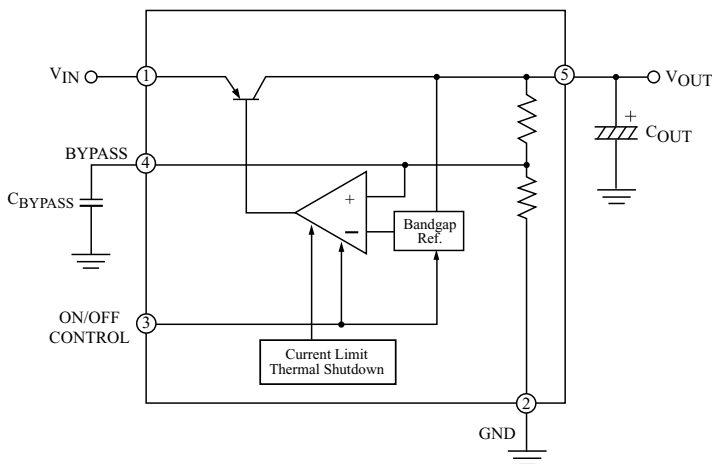

KR15S018M~KR15S033M

MAXIMUM RATINGS (Ta=25 °C)

CHARACTERISTIC	SYMBOL	RATING	UNIT
Supply Input Voltage	V _{IN}	16	V
ON/OFF Control Voltage	V _C	5	V
Output Current	I _{OUT}	150	mA
Power Dissipation (Note)	P _D	900	mW
Junction Temperature	T _j	150	°C
Operating Junction Temperature	T _{opr}	-40~125	°C
Storage Temperature	T _{stg}	-55~150	°C

Note) Package mounted on a ceramic board. (600m² × 0.8m)

ELECTRICAL CHARACTERISTICS

(Unless otherwise specified, V_{IN}=V_{OUT}+1V, I_{OUT}=100μA, C_{OUT}=4.7μF, T_j=25 °C)

CHARACTERISTIC		SYMBOL	TEST CONDITION	MIN.	TYP.	MAX.	UNIT
Output Voltage	KR15S018M	V _{OUT}	V _{IN} =V _{OUT} +1V	1.782	1.8	1.818	V
	KR15S025M			2.475	2.5	2.525	
	KR15S026M			2.574	2.6	2.626	
	KR15S027M			2.673	2.7	2.727	
	KR15S028M			2.772	2.8	2.828	
	KR15S285M			2.8215	2.85	2.8785	
	KR15S029M			2.871	2.9	2.929	
	KR15S030M			2.97	3.0	3.03	
	KR15S031M			3.069	3.1	3.131	
	KR15S033M			3.267	3.3	3.333	
Load Regulation	Reg Load	I _o =100~150mA	-	0.05	0.5	%	
Line Regulation	Reg Line	V _{IN} =V _{OUT} +1V~12V	-	0.009	0.05	%/V	
Dropout Voltage	V _{D-1}	I _{OUT} =100μA	-	10	60	mV	
	V _{D-2}	I _{OUT} =50mA	-	115	175	mV	
	V _{D-3}	I _{OUT} =150mA	-	175	300	mV	
Temperature Coefficient of output voltage	TCV _o	T _j =-40~125 °C	-	40	80	ppm/°C	
Ripple Rejection	RR	f=120Hz	-	75	-	dB	
Output Noise Voltage	V _{NO1}	I _{OUT} =50mA, C _{OUT} =2.2μF C _{BYPASS} =470pF	-	30	-	μVrms	
Output ON-state voltage for control	V _{C(ON)}	-	2.0	-	-	V	
Output ON-state current for control	I _{C(ON)}	V _C =2.0V	2	5	20	μA	
Output OFF-state voltage for control	V _{C(OFF)}	-	-	-	0.4	V	
Output OFF-state current for control	I _{C(OFF-1)}	V _C =0.4V	-	0.01	-1	μA	
	I _{C(OFF-2)}	V _C =0.18V	-	0.01	-2	μA	
Quiescent Current	I _{Q1}	V _C =3V, I _{OUT} =100μA	-	80	130	μA	
	I _{Q2}	V _C =3V, I _{OUT} =50mA	-	350	650	μA	
	I _{Q3}	V _C =3V, I _{OUT} =150mA	-	1.8	2.5	mA	
Quiescent Current (OFF Mode)	I _{Q(OFF-1)}	V _C =0.4V	-	0.05	3	μA	
	I _{Q(OFF-2)}	V _C =0.18V	-	0.10	8		

KR15S018M~KR15S033M

f_{IN} - R.R (1)

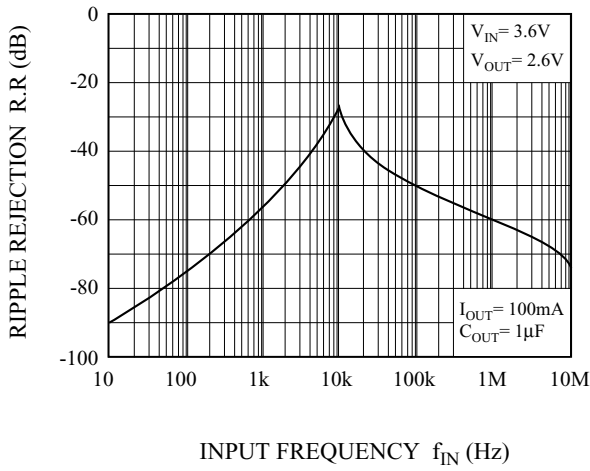

f_{IN} - R.R (2)

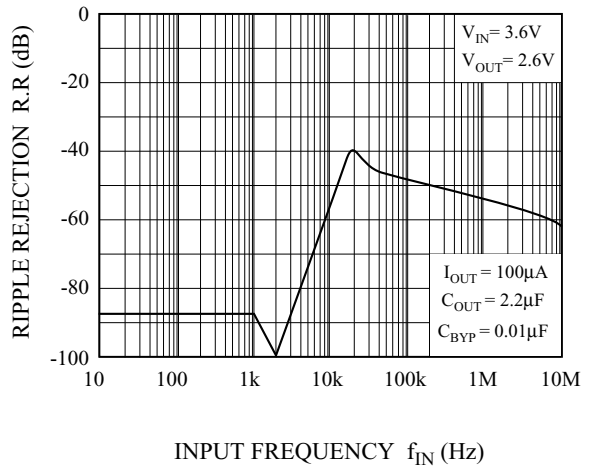

f_{IN} - R.R (3)

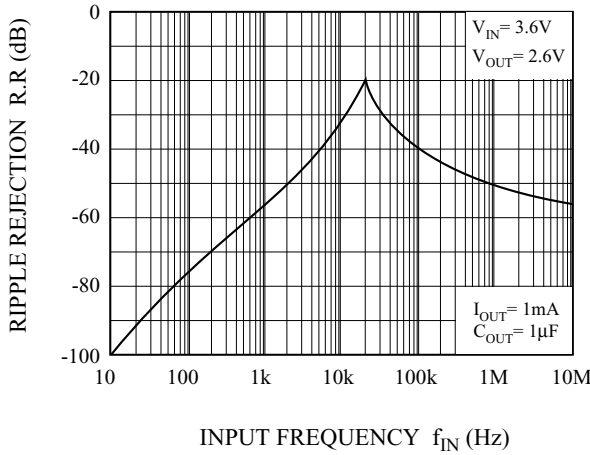

f_{IN} - R.R (4)

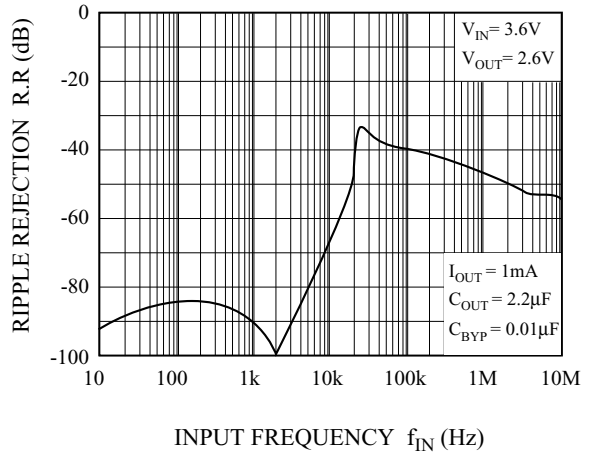

f_{IN} - R.R (5)

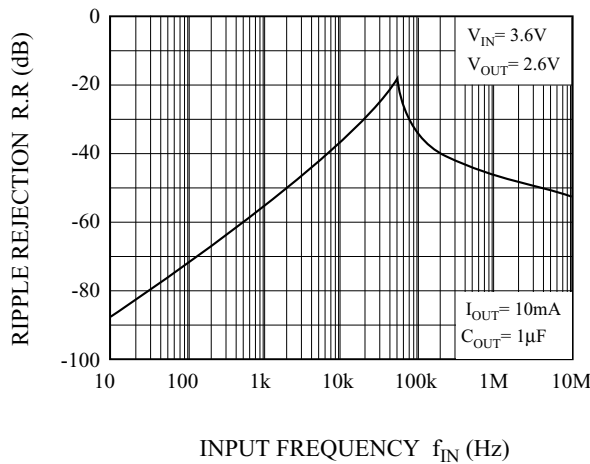

f_{IN} - R.R (6)

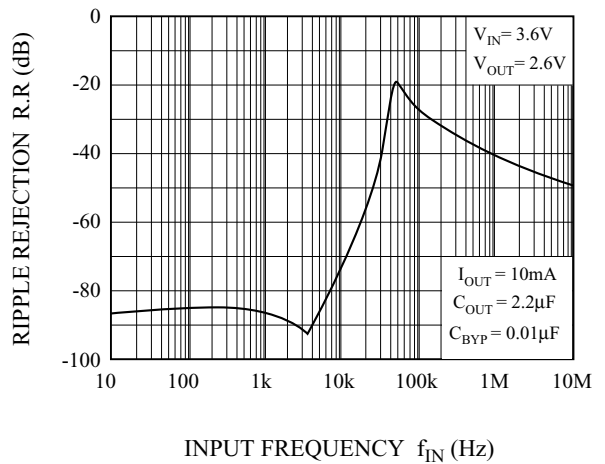

KR15S018M~KR15S033M

f_{IN} - R.R (7)

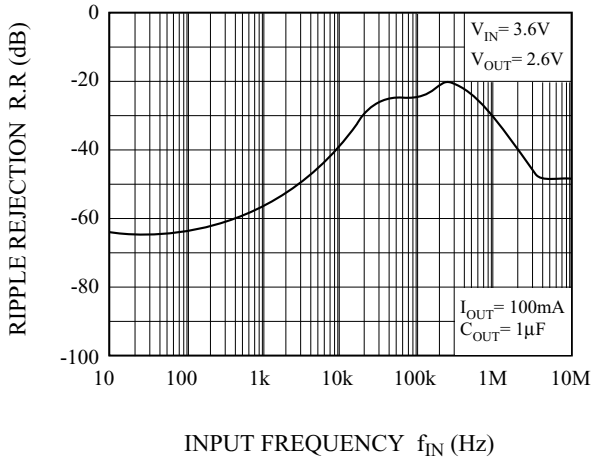

f_{IN} - R.R (8)

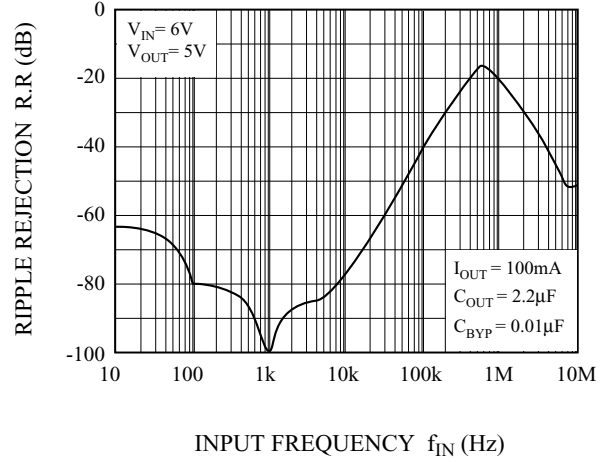

V_D - R.R (1)

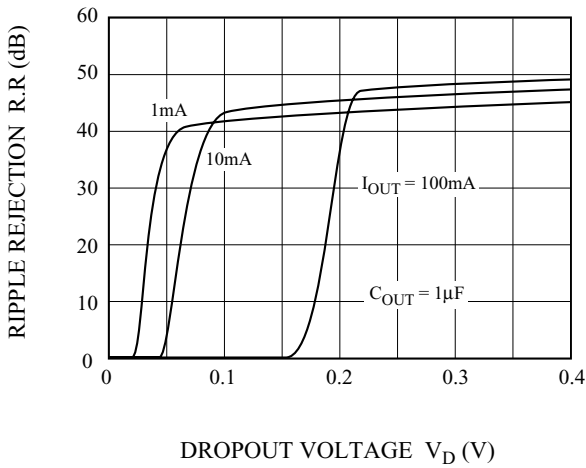

V_D - R.R (2)

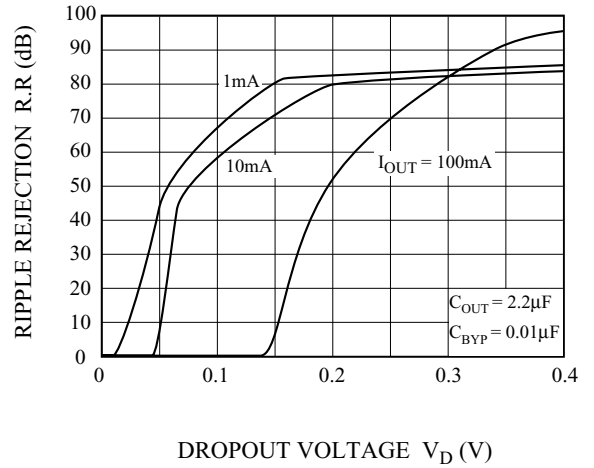

C_{BYPASS} - TIME

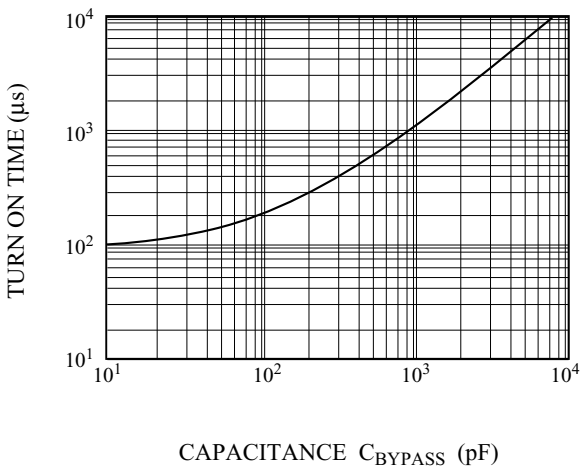

I_{OUT} - V_D

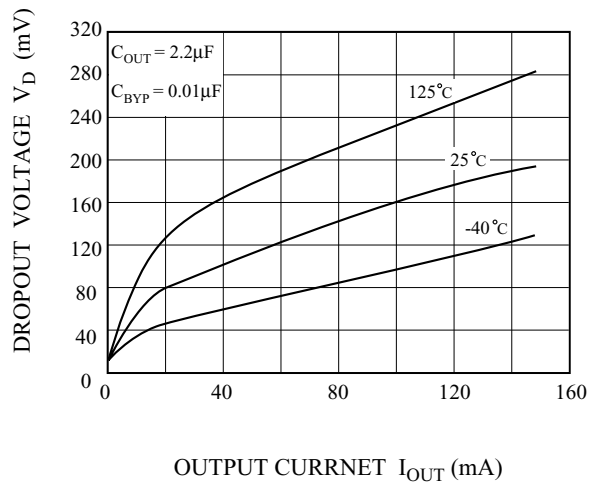

KR15S018M~KR15S033M

f - NOISE (1)

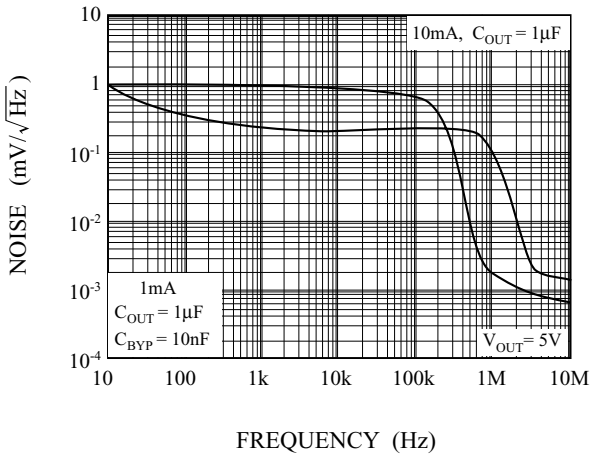

f - NOISE (2)

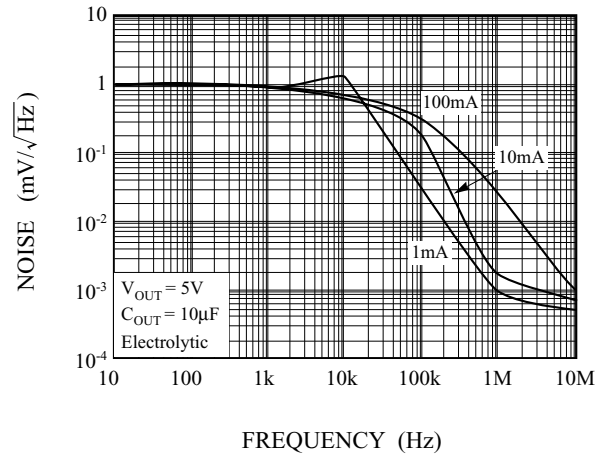

f - NOISE (3)

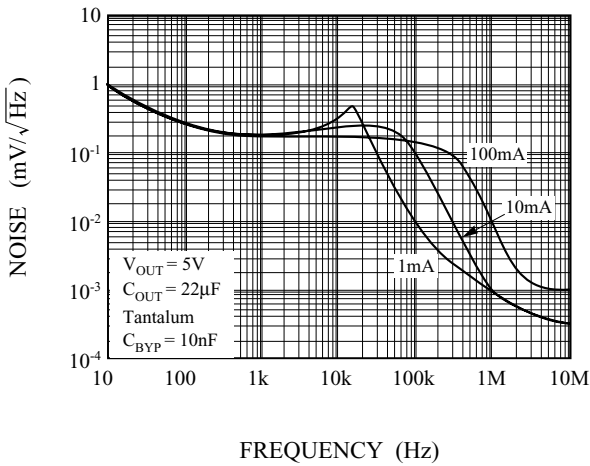

f - NOISE (4)

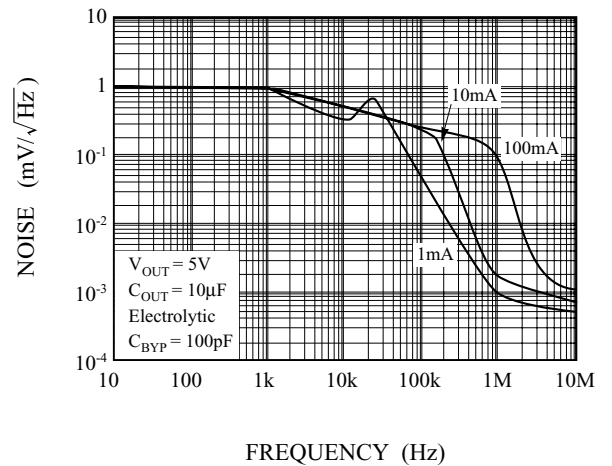

f - NOISE (5)

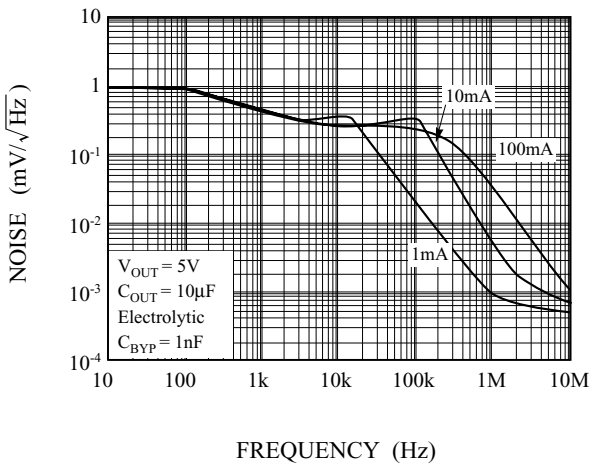

f - NOISE (6)

