

**Features**

- Advanced Process Technology
- Ultra Low On-Resistance
- 175°C Operating Temperature
- Fast Switching
- Repetitive Avalanche Allowed up to Tjmax

**Description**

Specifically designed for Automotive applications, this HEXFET® Power MOSFET utilizes the latest processing techniques to achieve extremely low on-resistance per silicon area. Additional features of this design are a 175°C junction operating temperature, fast switching speed and improved repetitive avalanche rating. These features combine to make this design an extremely efficient and reliable device for use in Automotive applications and a wide variety of other applications.

**HEXFET® Power MOSFET**

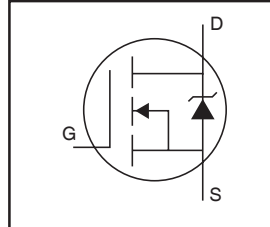

|                                   |
|-----------------------------------|
| $V_{DSS} = 75V$                   |
| $R_{DS(on)} = 4.5m\Omega^{\circ}$ |
| $I_D = 90A$                       |

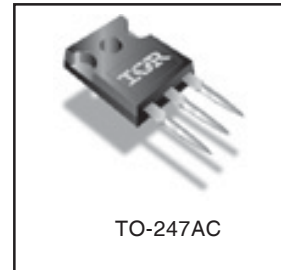

**Absolute Maximum Ratings**

|                            | Parameter  | Max.                  | Units |
|----------------------------|--|-----------------------|-------|
| $I_D @ T_C = 25^{\circ}C$  | Continuous Drain Current, $V_{GS} @ 10V$ (Silicon Limited) | 170                   | A     |
| $I_D @ T_C = 100^{\circ}C$ | Continuous Drain Current, $V_{GS} @ 10V$ (See Fig. 9)      | 120                   |       |
| $I_D @ T_C = 25^{\circ}C$  | Continuous Drain Current, $V_{GS} @ 10V$ (Package Limited) | 90                    |       |
| $I_{DM}$                   | Pulsed Drain Current ①                                     | 680                   |       |
| $P_D @ T_C = 25^{\circ}C$  | Maximum Power Dissipation                                  | 310                   | W     |
|                            | Linear Derating Factor                                     | 2.0                   | W/°C  |
| $V_{GS}$                   | Gate-to-Source Voltage                                     | $\pm 20$              | V     |
| $E_{AS}$                   | Single Pulse Avalanche Energy (Thermally Limited) ②        | 520                   | mJ    |
| $E_{AS} (tested)$          | Single Pulse Avalanche Energy Tested Value ②               | 690                   |       |
| $I_{AR}$                   | Avalanche Current ①  | See Fig.12a,12b,15,16 | A     |
| $E_{AR}$                   | Repetitive Avalanche Energy ③                              |                       | mJ    |
| $T_J$                      | Operating Junction and                                     | -55 to + 175          | °C    |
| $T_{STG}$                  | Storage Temperature Range                                  |                       |       |
|                            | Soldering Temperature, for 10 seconds                      |                       |       |
|                            | Mounting torque, 6-32 or M3 screw                          | 10 lbf•in (1.1N•m)    |       |

**Thermal Resistance**

|                 | Parameter                             | Typ. | Max. | Units |
|-----------------|---------------------------------------|------|------|-------|
| $R_{\theta JC}$ | Junction-to-Case ③                    | —    | 0.49 | °C/W  |
| $R_{\theta CS}$ | Case-to-Sink, Flat, Greased Surface ③ | 0.24 | —    |       |
| $R_{\theta JA}$ | Junction-to-Ambient ③                 | —    | 40   |       |

HEXFET® is a registered trademark of International Rectifier.

www.irf.com

## Static @ $T_J = 25^\circ\text{C}$ (unless otherwise specified)

|                              | Parameter                            | Min. | Typ.  | Max. | Units | Conditions  |
|------------------------------|--------------------------------------|------|-------|------|-------|---|
| $V_{(BR)DSS}$                | Drain-to-Source Breakdown Voltage    | 75   | —     | —    | V     | $V_{GS} = 0V, I_D = 250\mu A$   |
| $\Delta BV_{DSS}/\Delta T_J$ | Breakdown Voltage Temp. Coefficient  | —    | 0.069 | —    | V/°C  | Reference to $25^\circ\text{C}, I_D = 1\text{mA}$                           |
| $R_{DS(on)}$                 | Static Drain-to-Source On-Resistance | —    | 3.5   | 4.5  | mΩ    | $V_{GS} = 10V, I_D = 90A$ ④   |
| $V_{GS(th)}$                 | Gate Threshold Voltage               | 2.0  | —     | 4.0  | V     | $V_{DS} = V_{GS}, I_D = 250\mu A$   |
| gfs                          | Forward Transconductance             | 180  | —     | —    | S     | $V_{DS} = 25V, I_D = 90A$   |
| $I_{DSS}$                    | Drain-to-Source Leakage Current      | —    | —     | 20   | μA    | $V_{DS} = 75V, V_{GS} = 0V$   |
|                              |                                      | —    | —     | 250  |       | $V_{DS} = 75V, V_{GS} = 0V, T_J = 125^\circ\text{C}$                        |
| $I_{GSS}$                    | Gate-to-Source Forward Leakage       | —    | —     | 200  | nA    | $V_{GS} = 20V$  |
|                              | Gate-to-Source Reverse Leakage       | —    | —     | -200 |       | $V_{GS} = -20V$   |
| $Q_g$                        | Total Gate Charge                    | —    | 180   | 270  | nC    | $I_D = 90A$   |
| $Q_{gs}$                     | Gate-to-Source Charge                | —    | 46    | —    |       | $V_{DS} = 60V$  |
| $Q_{gd}$                     | Gate-to-Drain ("Miller") Charge      | —    | 65    | —    |       | $V_{GS} = 10V$ ④  |
| $t_{d(on)}$                  | Turn-On Delay Time                   | —    | 19    | —    | ns    | $V_{DD} = 38V$  |
| $t_r$                        | Rise Time                            | —    | 140   | —    |       | $I_D = 90A$   |
| $t_{d(off)}$                 | Turn-Off Delay Time                  | —    | 97    | —    |       | $R_G = 2.5\Omega$   |
| $t_f$                        | Fall Time                            | —    | 100   | —    |       | $V_{GS} = 10V$ ④  |
| $L_D$                        | Internal Drain Inductance            | —    | 5.0   | —    | nH    | Between lead,<br>6mm (0.25in.)<br>from package<br>and center of die contact |
| $L_S$                        | Internal Source Inductance           | —    | 13    | —    |       |   |
| $C_{iss}$                    | Input Capacitance                    | —    | 7500  | —    | pF    | $V_{GS} = 0V$   |
| $C_{oss}$                    | Output Capacitance                   | —    | 970   | —    |       | $V_{DS} = 25V$  |
| $C_{rss}$                    | Reverse Transfer Capacitance         | —    | 510   | —    |       | $f = 1.0\text{MHz}$ , See Fig. 5  |
| $C_{oss}$                    | Output Capacitance                   | —    | 3640  | —    |       | $V_{GS} = 0V, V_{DS} = 1.0V, f = 1.0\text{MHz}$                             |
| $C_{oss}$                    | Output Capacitance                   | —    | 650   | —    |       | $V_{GS} = 0V, V_{DS} = 60V, f = 1.0\text{MHz}$                              |
| $C_{oss\ eff.}$              | Effective Output Capacitance         | —    | 1020  | —    |       | $V_{GS} = 0V, V_{DS} = 0V$ to $60V$   |

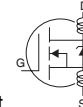

## Diode Characteristics

|          | Parameter                                 | Min.  | Typ. | Max. | Units | Conditions   |
|----------|---|---|------|------|-------|--|
| $I_S$    | Continuous Source Current<br>(Body Diode) | —   | —    | 90   | A     | MOSFET symbol<br>showing the<br>integral reverse   |
| $I_{SM}$ | Pulsed Source Current<br>(Body Diode) ①   | —   | —    | 680  |       | p-n junction diode.                                |
| $V_{SD}$ | Diode Forward Voltage                     | —   | —    | 1.3  | V     | $T_J = 25^\circ\text{C}, I_S = 90A, V_{GS} = 0V$ ④ |
| $t_{rr}$ | Reverse Recovery Time                     | —   | 41   | 61   | ns    | $T_J = 25^\circ\text{C}, I_F = 90A, V_{DD} = 38V$  |
| $Q_{rr}$ | Reverse Recovery Charge                   | —   | 59   | 89   | nC    | $di/dt = 100A/\mu s$ ④                             |
| $t_{on}$ | Forward Turn-On Time                      | Intrinsic turn-on time is negligible (turn-on is dominated by $L_S+L_D$ ) |      |      |       |  |

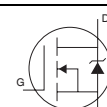

### Notes:

- ① Repetitive rating; pulse width limited by max. junction temperature. (See fig. 11).
- ② Limited by  $T_{Jmax}$ , starting  $T_J = 25^\circ\text{C}$ ,  $L = 0.13\text{mH}$ ,  $R_G = 25\Omega$ ,  $I_{AS} = 90A$ ,  $V_{GS} = 10V$ . Part not recommended for use above this value.
- ③  $I_{SD} \leq 90A$ ,  $di/dt \leq 340A/\mu s$ ,  $V_{DD} \leq V_{(BR)DSS}$ ,  $T_J \leq 175^\circ\text{C}$ .
- ④ Pulse width  $\leq 1.0\text{ms}$ ; duty cycle  $\leq 2\%$ .
- ⑤  $C_{oss\ eff.}$  is a fixed capacitance that gives the same charging time as  $C_{oss}$  while  $V_{DS}$  is rising from 0 to 80%  $V_{DSS}$ .
- ⑥ Limited by  $T_{Jmax}$ , see Fig.12a, 12b, 15, 16 for typical repetitive avalanche performance.
- ⑦ This value determined from sample failure population. 100% tested to this value in production.
- ⑧  $R_{\theta}$  is measured at  $T_J$  of approximately  $90^\circ\text{C}$ .

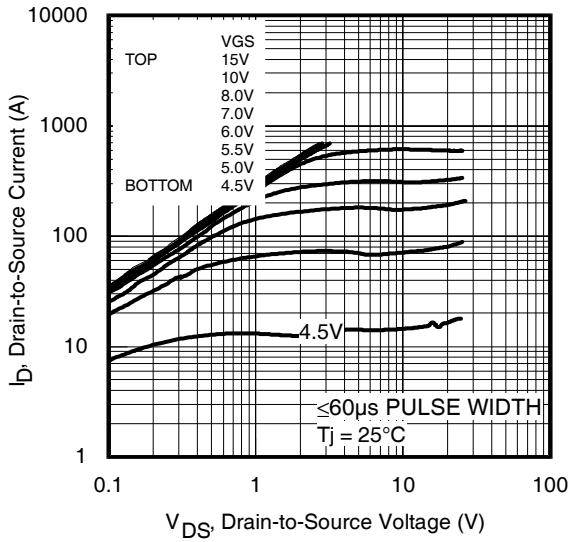

Fig 1. Typical Output Characteristics

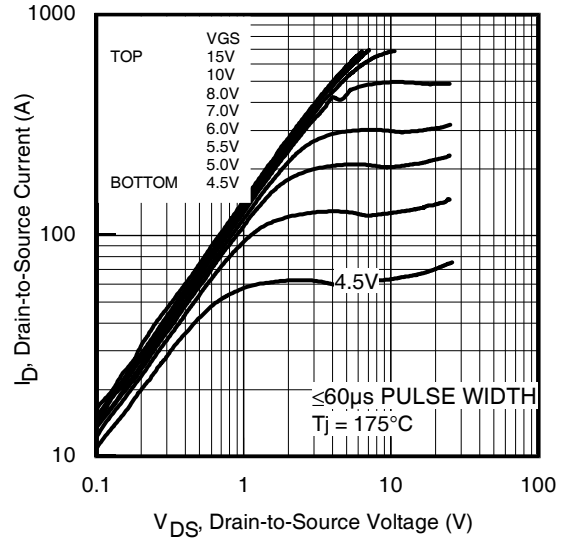

Fig 2. Typical Output Characteristics

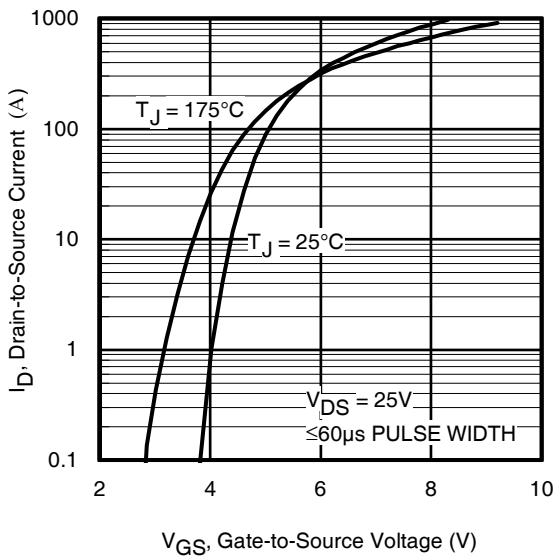

Fig 3. Typical Transfer Characteristics

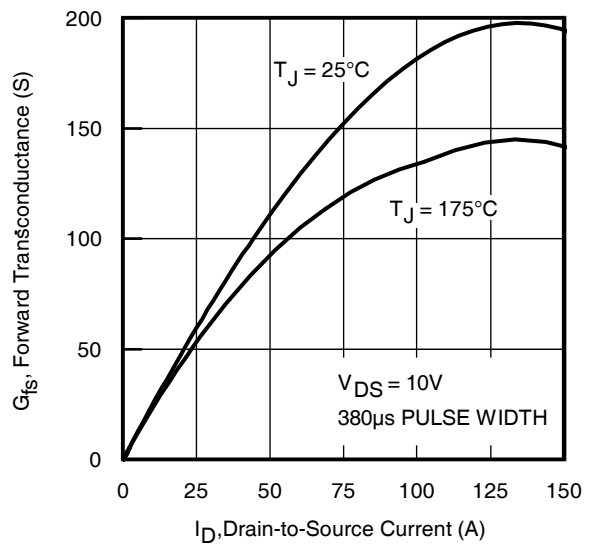
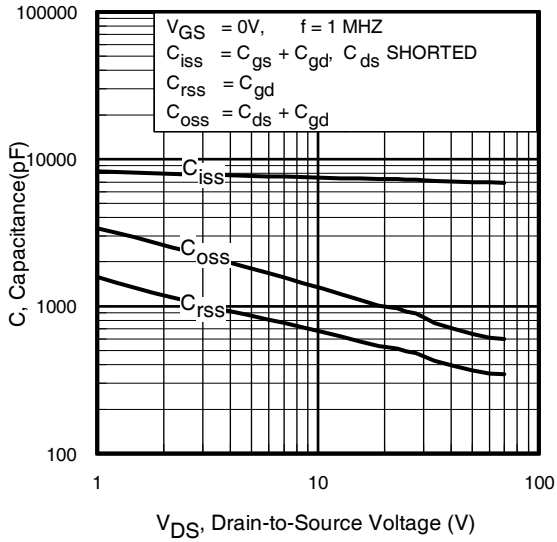
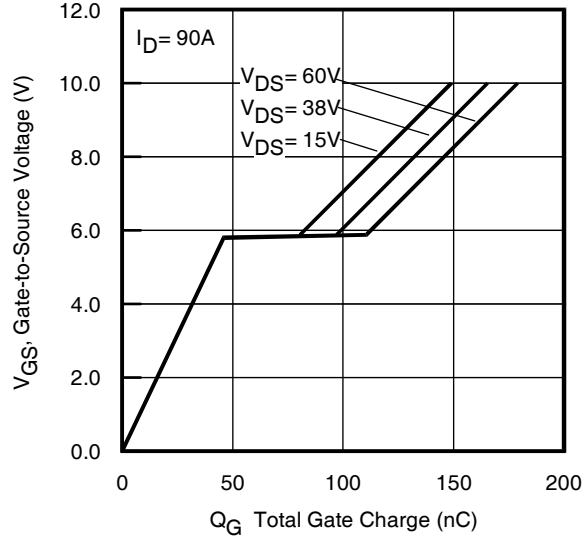

Fig 4. Typical Forward Transconductance vs. Drain Current



**Fig 5.** Typical Capacitance vs. Drain-to-Source Voltage



**Fig 6.** Typical Gate Charge vs. Gate-to-Source Voltage

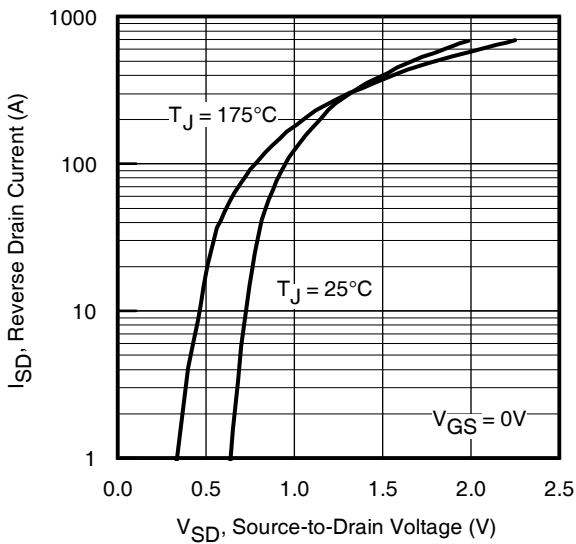

**Fig 7.** Typical Source-Drain Diode Forward Voltage

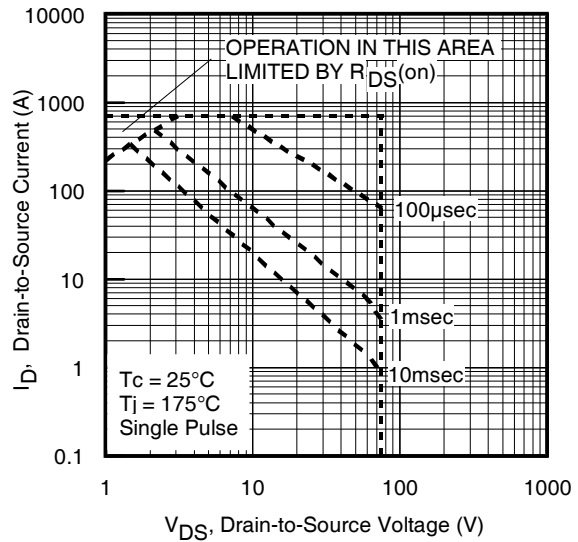

**Fig 8.** Maximum Safe Operating Area

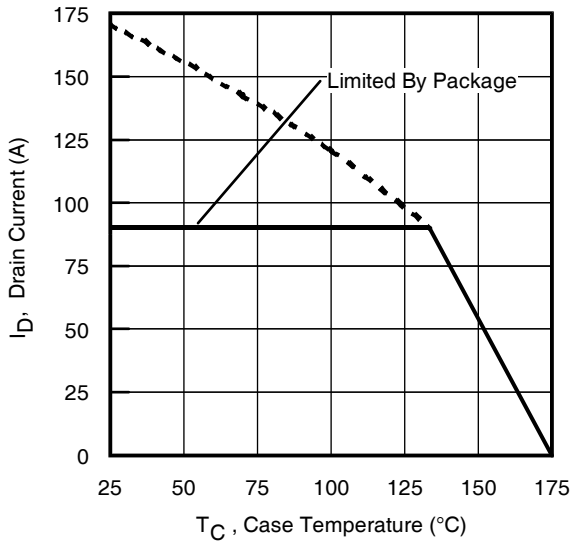

**Fig 9.** Maximum Drain Current vs. Case Temperature

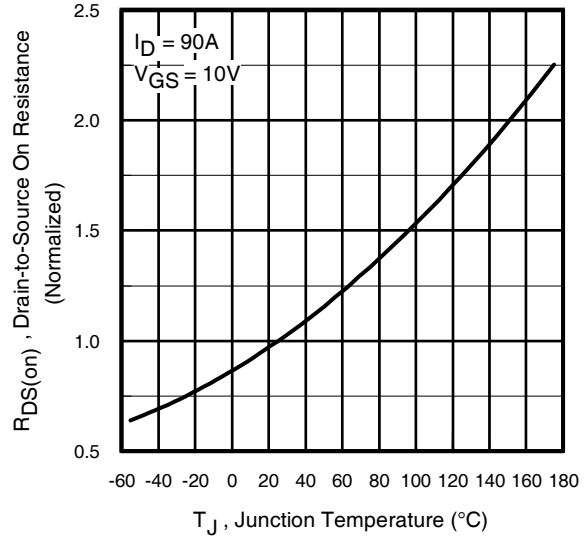

**Fig 10.** Normalized On-Resistance vs. Temperature

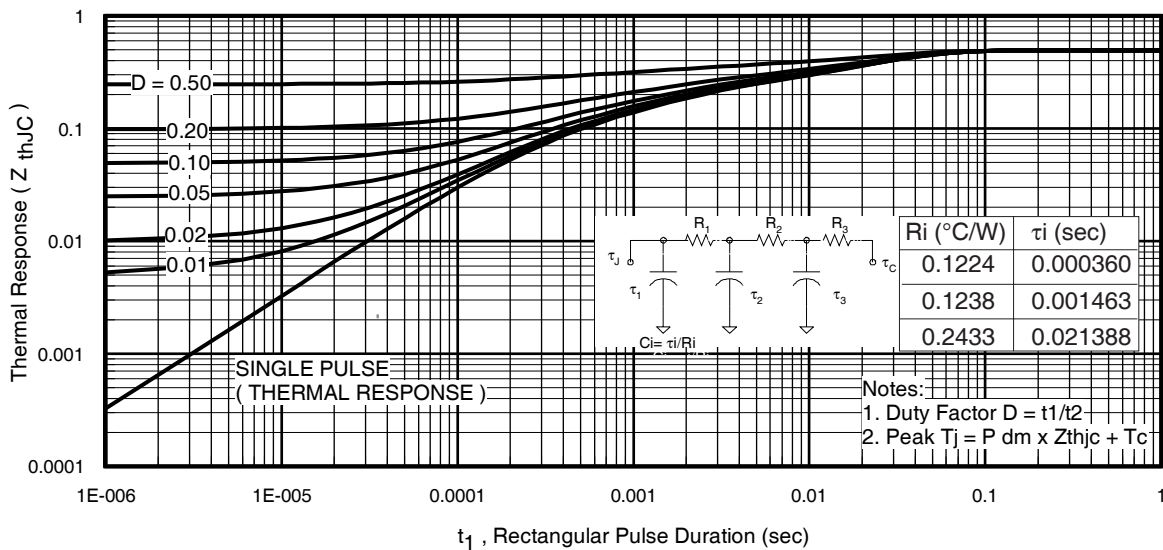

**Fig 11.** Maximum Effective Transient Thermal Impedance, Junction-to-Case

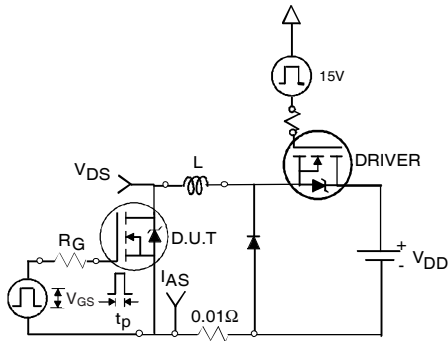

**Fig 12a.** Unclamped Inductive Test Circuit

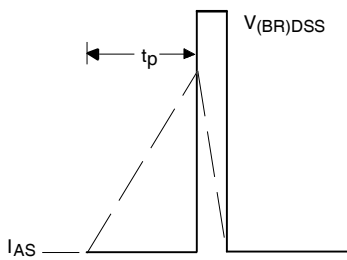

**Fig 12b.** Unclamped Inductive Waveforms



**Fig 13a.** Basic Gate Charge Waveform

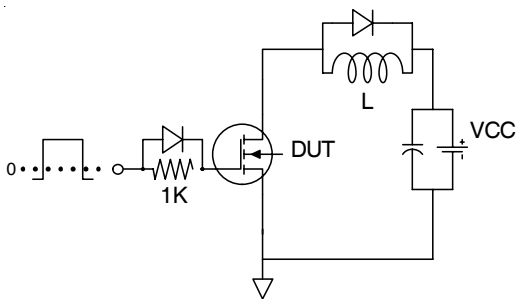

**Fig 13b.** Gate Charge Test Circuit

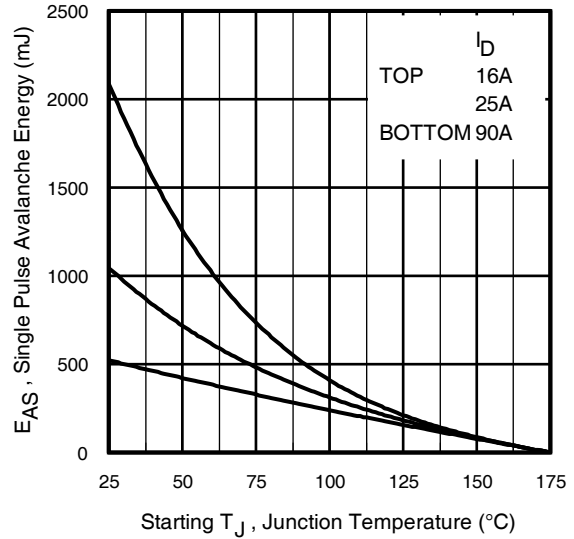

**Fig 12c.** Maximum Avalanche Energy vs. Drain Current

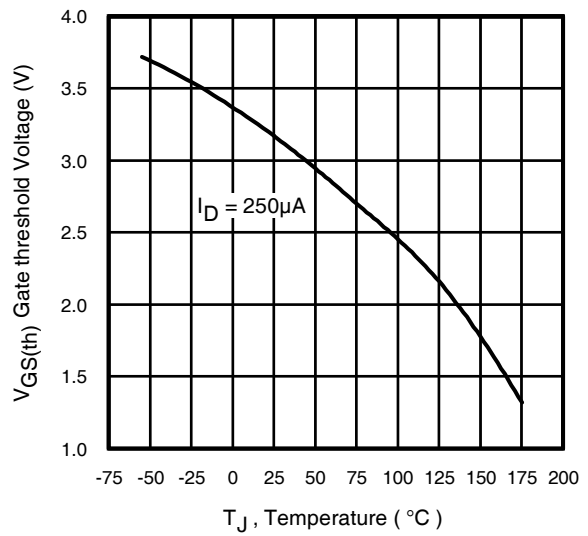

**Fig 14.** Threshold Voltage vs. Temperature

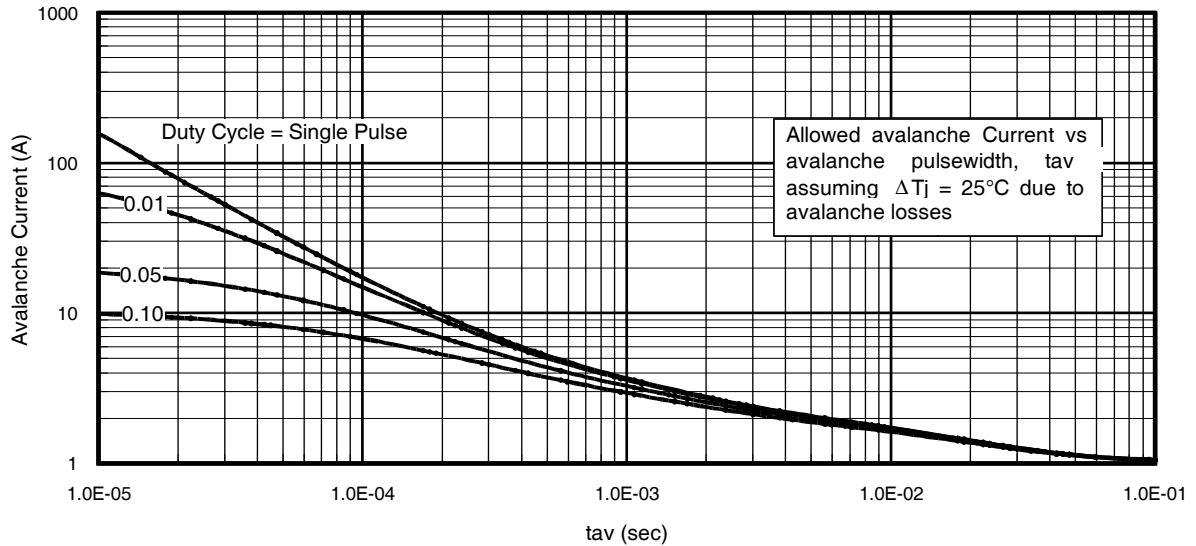

Fig 15. Typical Avalanche Current Vs.Pulsewidth

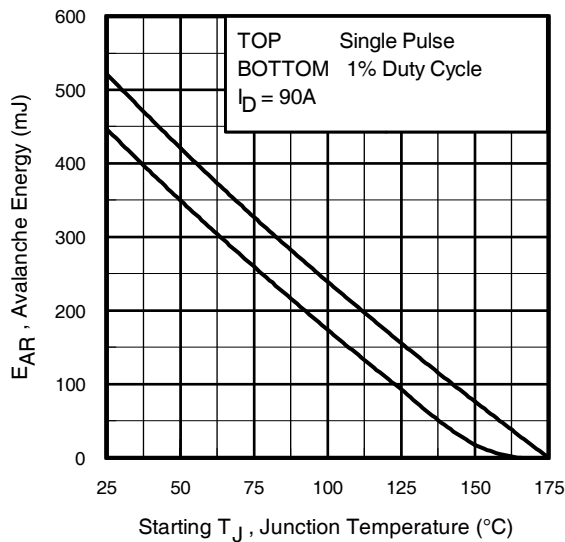

Fig 16. Maximum Avalanche Energy vs. Temperature

**Notes on Repetitive Avalanche Curves , Figures 15, 16:**  
(For further info, see AN-1005 at [www.irf.com](http://www.irf.com))

1. Avalanche failures assumption:  
Purely a thermal phenomenon and failure occurs at a temperature far in excess of  $T_{jmax}$ . This is validated for every part type.
2. Safe operation in Avalanche is allowed as long as  $T_{jmax}$  is not exceeded.
3. Equation below based on circuit and waveforms shown in Figures 12a, 12b.
4.  $P_{D(ave)}$  = Average power dissipation per single avalanche pulse.
5. BV = Rated breakdown voltage (1.3 factor accounts for voltage increase during avalanche).
6.  $I_{av}$  = Allowable avalanche current.
7.  $\Delta T$  = Allowable rise in junction temperature, not to exceed  $T_{jmax}$  (assumed as 25°C in Figure 15, 16).  
 $t_{av}$  = Average time in avalanche.  
 $D$  = Duty cycle in avalanche =  $t_{av} \cdot f$   
 $Z_{thJC}(D, t_{av})$  = Transient thermal resistance, see figure 11)

$$P_{D(ave)} = 1/2 ( 1.3 \cdot BV \cdot I_{av} ) = \Delta T / Z_{thJC}$$

$$I_{av} = 2\Delta T / [1.3 \cdot BV \cdot Z_{th}]$$

$$E_{AS(AR)} = P_{D(ave)} \cdot t_{av}$$

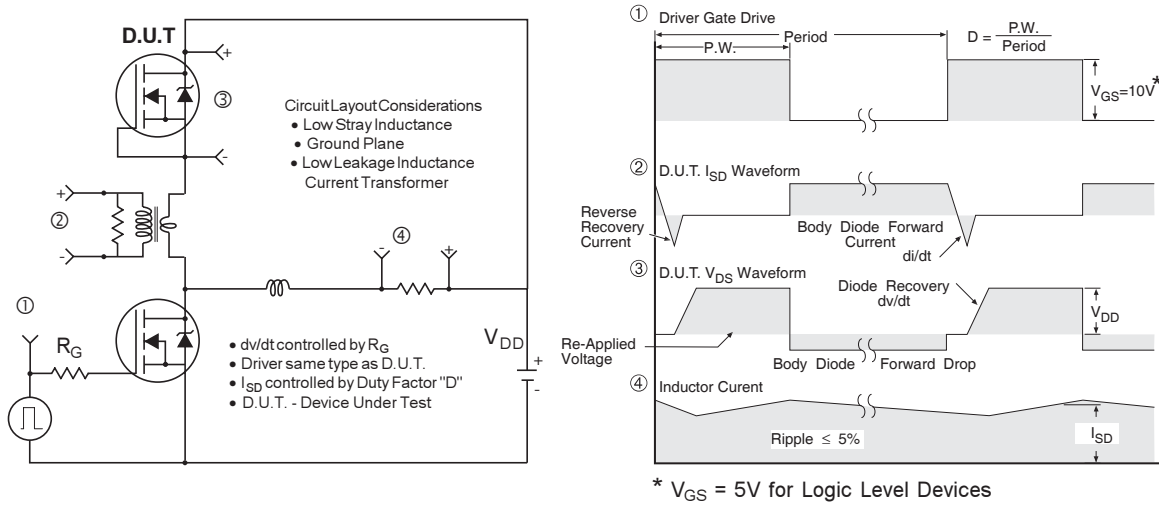

**Fig 17.** Peak Diode Recovery  $dv/dt$  Test Circuit for N-Channel HEXFET<sup>®</sup> Power MOSFETs

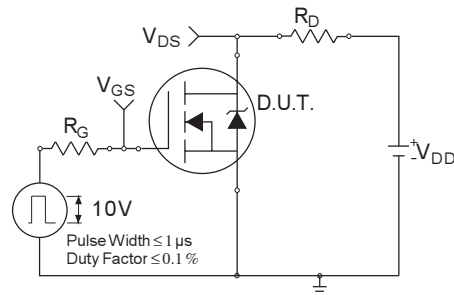

**Fig 18a.** Switching Time Test Circuit

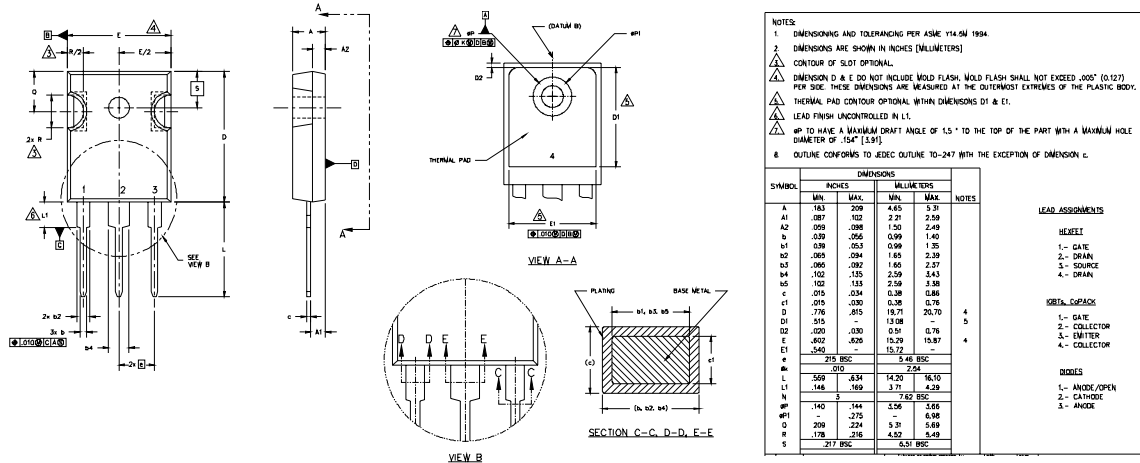

**Fig 18b.** Switching Time Waveforms



## TO-247AC Package Outline

Dimensions are shown in millimeters (inches)



## TO-247AC Part Marking Information

Notes: This part marking information applies to devices produced before 02/26/2001 or for parts manufactured in GB.

EXAMPLE: THIS IS AN IRFPE30  
WITH ASSEMBLY  
LOT CODE 3A1Q

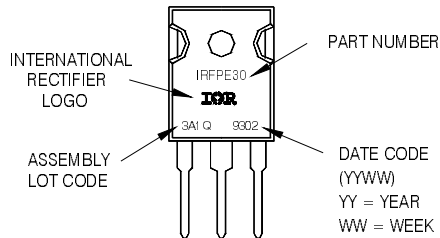

Notes: This part marking information applies to devices produced after 02/26/2001

EXAMPLE: THIS IS AN IRFPE30  
WITH ASSEMBLY  
LOT CODE 5657  
ASSEMBLED ON WW 35, 2000  
IN THE ASSEMBLY LINE 'H'

**Note:** "P" in assembly line position indicates "Lead-Free"

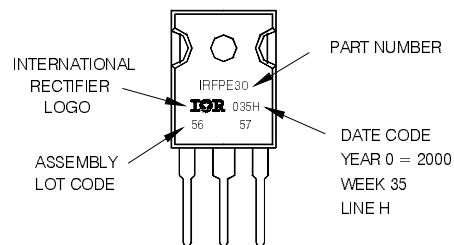

**TO-247AC package is not recommended for Surface Mount Application.**

Data and specifications subject to change without notice.  
This product has been designed and qualified for the Automotive [Q101] market.  
Qualification Standards can be found on IR's Web site.