

WIDEBAND DRIVER AMPLIFIER MODULE, 2 - 35 GHz



Typical Applications

The HMC-C038 Wideband Driver is ideal for:

- Telecom Infrastructure
- Microwave Radio & VSAT
- Military & Space
- Test Instrumentation
- Fiber Optics

Functional Diagram

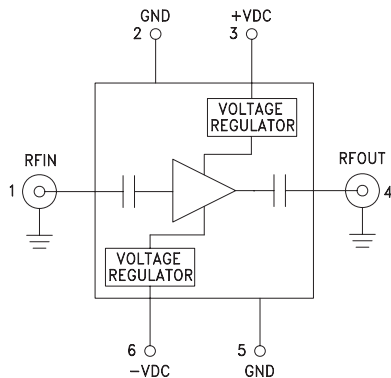

Features

- Gain: 12 dB @ 10 GHz
- P1dB Output Power: +18 dBm @ 10 GHz
- Regulated Supply and Bias Sequencing
- Hermetically Sealed Module
- Field Replaceable 2.92 mm Connectors
- 55 to +85°C Operating Temperature

General Description

The HMC-C038 is a GaAs PHEMT MMIC Distributed Power Amplifier in a miniature, hermetic module with replaceable 2.92mm connectors which operates between 2 and 35 GHz. The amplifier provides 12 dB of gain, +29 dBm output IP3 and up to +18 dBm of output power at 1 dB gain compression. Gain flatness is excellent from 2 - 16 GHz making the HMC-C038 ideal for EW, ECM RADAR and test equipment applications. The wideband amplifier I/Os are internally matched to 50 Ohms and are DC blocked. Integrated voltage regulators allow for flexible biasing of both the negative and positive supply pins, while internal bias sequencing circuitry assures robust operation.

Electrical Specifications, $T_A = +25^\circ\text{C}$, +VDC = +11V to +16V, -VDC = -4V to -12V

Parameter	Min.	Typ.	Max.	Min.	Typ.	Max.	Min.	Typ.	Max.	Units
Frequency Range	2 - 15			15 - 27			27 - 35			GHz
Gain	9	12		8	11		6	9		dB
Gain Flatness		±0.5			±0.4			±1.5		dB
Gain Variation Over Temperature		0.02	0.03		0.02	0.03		0.02	0.03	dB/°C
Noise Figure		3.0			4.0			6.0		dB
Input Return Loss		15			10			6		dB
Output Return Loss		15			13			13		dB
Output Power for 1 dB Compression (P1dB)	15	18		13	16		10	14		dBm
Saturated Output Power (Psat)		20			18.5			15.5		dBm
Output Third Order Intercept (IP3)		29			26			25		dBm
Positive Supply Current (+IDC)		92			92			92		mA
Negative Supply Current (-IDC)		5.3			5.3			5.3		mA

For price, delivery, and to place orders, please contact Hittite Microwave Corporation:
20 Alpha Road Chelmsford, MA 01824 Phone: 978-250-3343 Fax: 978-250-3373
Order Online at www.hittite.com

**WIDEBAND DRIVER AMPLIFIER
MODULE, 2 - 35 GHz**

Gain & Return Loss

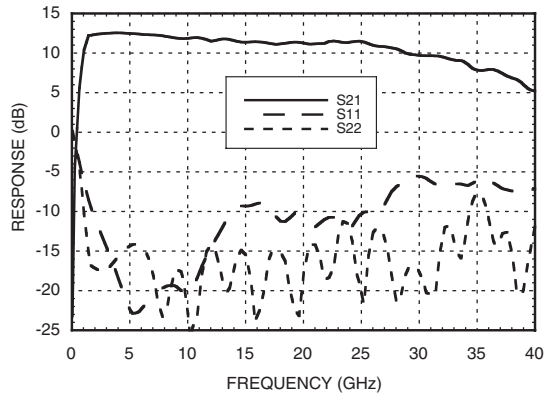

Gain vs. Temperature

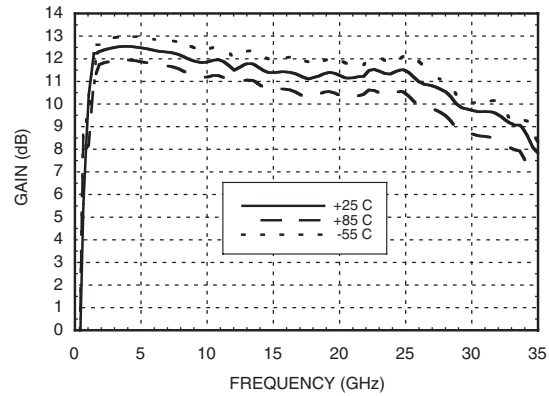

Input Return Loss vs. Temperature

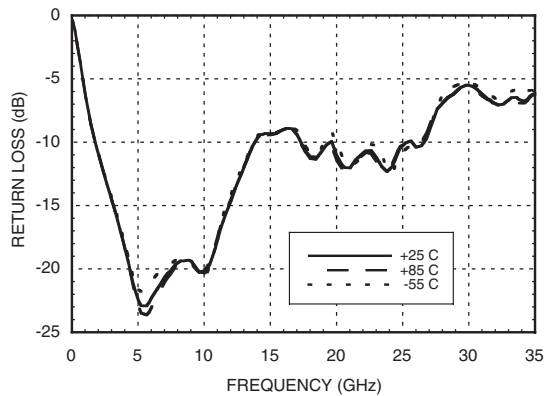

Output Return Loss vs. Temperature

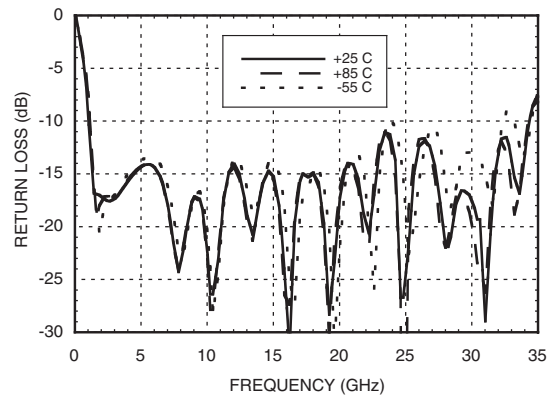

Reverse Isolation vs. Temperature

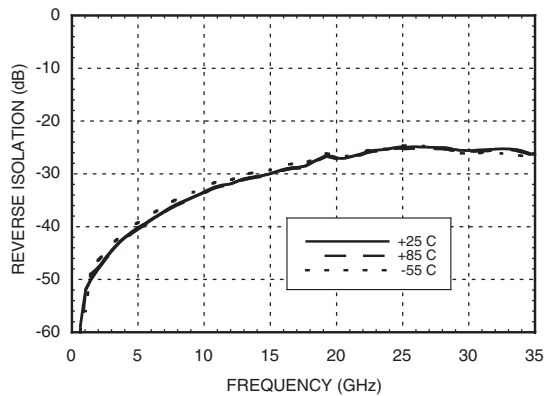

Noise Figure vs. Temperature

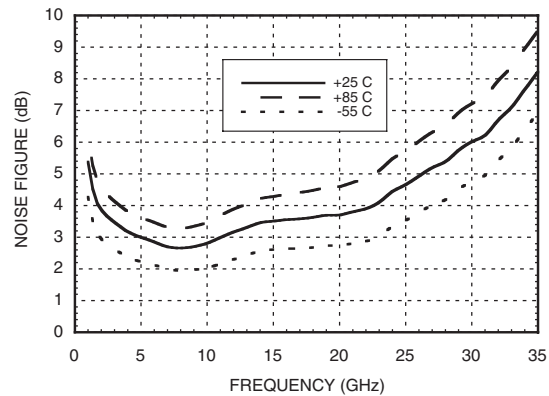

WIDEBAND DRIVER AMPLIFIER MODULE, 2 - 35 GHz

P1dB vs. Temperature

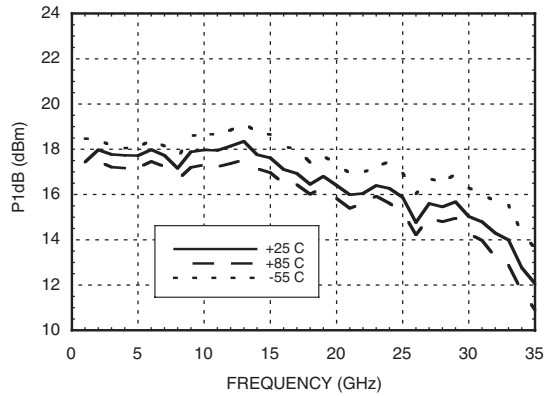

Psat vs. Temperature

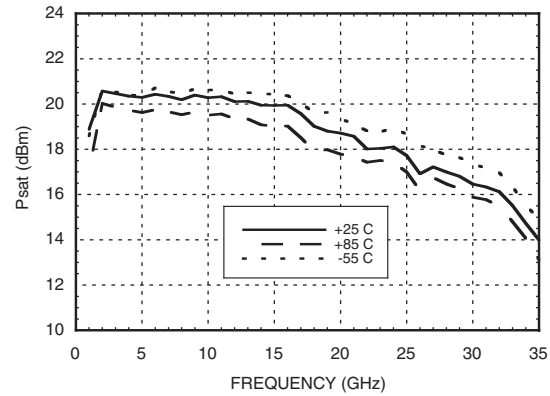

Output IP3 vs. Temperature

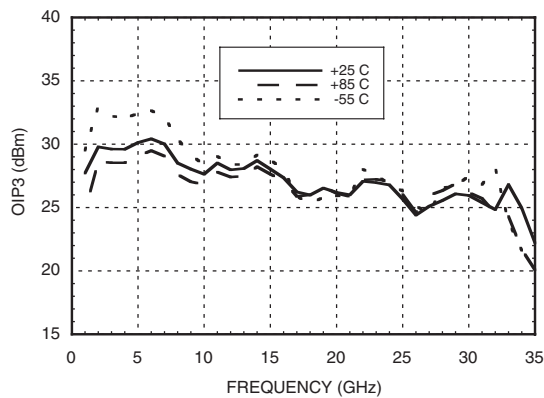

Absolute Maximum Ratings



Positive Bias Supply Voltage (+VDC)	+17V Max
Negative Bias Supply (-VDC)	-16V Min.
RF Input Power (RFIn)	+23 dBm
Storage Temperature	-65 to +150 °C
Operating Temperature	-55 to +85 °C



**ELECTROSTATIC SENSITIVE DEVICE
OBSERVE HANDLING PRECAUTIONS**

**WIDEBAND DRIVER AMPLIFIER
MODULE, 2 - 35 GHz**

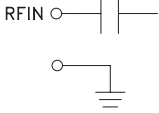
Pin Descriptions

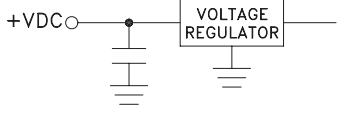
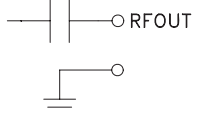
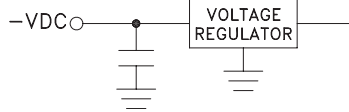
Pin Number	Function	Description	Interface Schematic
1	RFIN & RF Ground	RF input connector, 2.92 mm female, field replaceable. This pin is AC coupled and matched to 50 Ohms from 2 - 35 GHz.	
2, 5	GND	Power supply ground.	
3	+VDC	Positive power supply voltage for the amplifier.	
4	RFOUT & RF Ground	RF output connector, 2.92 mm female field replaceable. This pin is AC coupled and matched to 50 Ohms from 2 - 35 GHz.	
6	-VDC	Negative power supply voltage for the amplifier	

**WIDEBAND DRIVER AMPLIFIER
MODULE, 2 - 35 GHz**

Outline Drawing

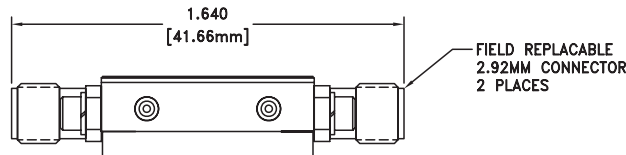
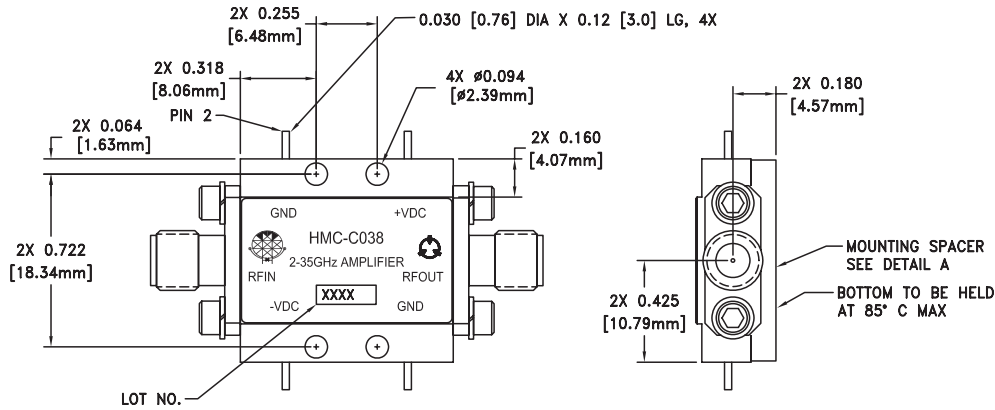

Typical Package Weight

Package	18.7 gms
Spacer	3.3 gms
+/- 1 gms Tolerance	

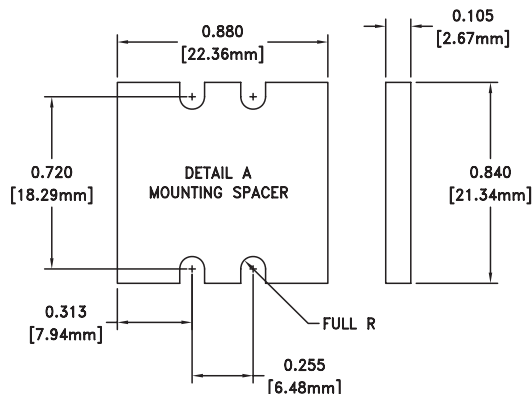
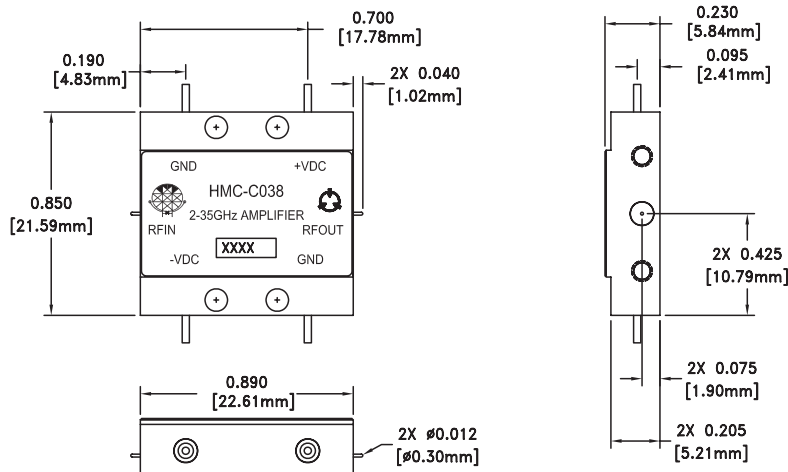

NOTES:

1. PACKAGE, LEADS, COVER MATERIAL: KOVAR™
2. SPACER MATERIAL: ALUMINUM
3. PLATING: ELECTROLYTIC GOLD 50 MICROINCHES MIN., OVER ELECTROLYTIC NICKEL 75 MICROINCHES MIN.
4. ALL DIMENSIONS ARE IN INCHES [MILLIMETERS].
5. TOLERANCES \pm 0.010 [0.24] UNLESS OTHERWISE SPECIFIED.

**WIDEBAND DRIVER AMPLIFIER
MODULE, 2 - 35 GHz**

Notes: