

HFA08TA60CPbF

HEXFRED™

Ultrafast, Soft Recovery Diode

Features

- Ultrafast Recovery
- Ultrasoft Recovery
- Very Low I_{RRM}
- Very Low Q_{rr}
- Specified at Operating Conditions
- Lead-Free

Benefits

- Reduced RFI and EMI
- Reduced Power Loss in Diode and Switching Transistor
- Higher Frequency Operation
- Reduced Snubbing
- Reduced Parts Count

Description

International Rectifier's HFA08TA60C is a state of the art center tap ultra fast recovery diode. Employing the latest in epitaxial construction and advanced processing techniques it features a superb combination of characteristics which result in performance which is unsurpassed by any rectifier previously available. With basic ratings of 600 volts and 4 amps per Leg continuous current, the HFA08TA60C is especially well suited for use as the companion diode for IGBTs and MOSFETs. In addition to ultra fast recovery time, the HEXFRED product line features extremely low values of peak recovery current (I_{RRM}) and does not exhibit any tendency to "snap-off" during the t_b portion of recovery. The HEXFRED features combine to offer designers a rectifier with lower noise and significantly lower switching losses in both the diode and the switching transistor. These HEXFRED advantages can help to significantly reduce snubbing, component count and heatsink sizes. The HEXFRED HFA08TA60C is ideally suited for applications in power supplies and power conversion systems (such as inverters), motor drives, and many other similar applications where high speed, high efficiency is needed.

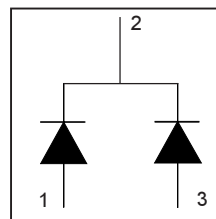

$V_R = 600V$
$V_F = 1.8V$
$Q_{rr}^* = 40nC$
$di_{(rec)M}/dt^* = 280A/\mu s$
* 125°C

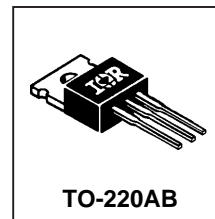

Absolute Maximum Ratings

	Parameter	Max	Units
V_R	Cathode-to-Anode Voltage	600	V
$I_F @ T_C = 100^\circ C$	Continuous Forward Current	4.0	A
I_{FSM}	Single Pulse Forward Current	25	
I_{FRM}	Maximum Repetitive Forward Current	16	
$P_D @ T_C = 25^\circ C$	Maximum Power Dissipation	25	W
$P_D @ T_C = 100^\circ C$	Maximum Power Dissipation	10	
T_J T_{STG}	Operating Junction and Storage Temperature Range	- 55 to +150	C

Electrical Characteristics @ T_J = 25°C (unless otherwise specified)

	Parameter	Min	Typ	Max	Units	Test Conditions	
V _{BR}	Cathode Anode Breakdown Voltage	600			V	I _R = 100μA	
V _{FM}	Max Forward Voltage		1.5	1.8	V	I _F = 4.0A	
			1.8	2.2		I _F = 8.0A	See Fig. 1
			1.4	1.7		I _F = 4.0A, T _J = 125°C	
I _{RM}	Max Reverse Leakage Current		0.17	3.0	μA	V _R = V _R Rated	
			44	300		T _J = 125°C, V _R = 0.8 x V _R Rated	See Fig. 2
C _T	Junction Capacitance		4.0	8.0	pF	V _R = 200V	
L _S	Series Inductance		8.0		nH	Measured lead to lead 5mm from package body	

Dynamic Recovery Characteristics @ T_J = 25°C (unless otherwise specified)

	Parameter	Min	Typ	Max	Units	Test Conditions	
t _{rr}	Reverse Recovery Time		17		ns	I _F = 1.0A, di/dt = 200A/μs, V _R = 30V	
t _{rr1}	See Fig. 5, 6 & 16		28	42			T _J = 25°C
t _{rr2}			38	57			T _J = 125°C
I _{RRM1}	Peak Recovery Current		2.9	5.2	A	T _J = 25°C	
I _{RRM2}	See Fig. 7 & 8		3.7	6.7			T _J = 125°C
Q _{rr1}	Reverse Recovery Charge		40	60	nC	T _J = 25°C	
Q _{rr2}	See Fig. 9 & 10		70	105			T _J = 125°C
di _{(rec)M} /dt1	Peak Rate of Fall of Recovery Current		280		A/μs	T _J = 25°C	
di _{(rec)M} /dt2	During t _b See Fig. 11 & 12		235				T _J = 125°C

Thermal - Mechanical Characteristics

	Parameter	Min	Typ	Max	Units
T _{lead} ①	Lead Temperature			300	°C
R _{thJC}	Thermal Resistance, Junction to Case			5.0	K/W
R _{thJA} ②	Thermal Resistance, Junction to Ambient			80	
R _{thCS} ③	Thermal Resistance, Case to Heat Sink		0.5		
Wt	Weight		2.0		g
T	Mounting Torque		6.0		Kg-cm
			5.0		lbf-in

① 0.063 in. from Case (1.6mm) for 10 sec

② Typical Socket Mount

③ Mounting Surface, Flat, Smooth and Greased

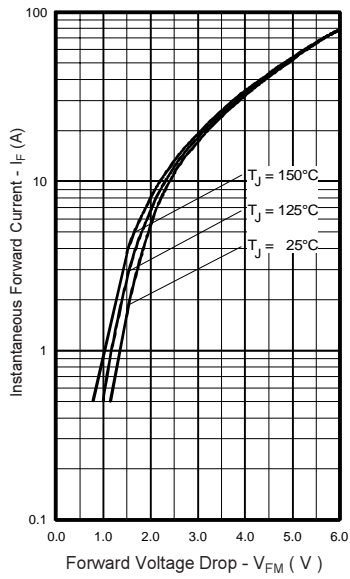

Fig. 1 - Maximum Forward Voltage Drop vs. Instantaneous Forward Current,

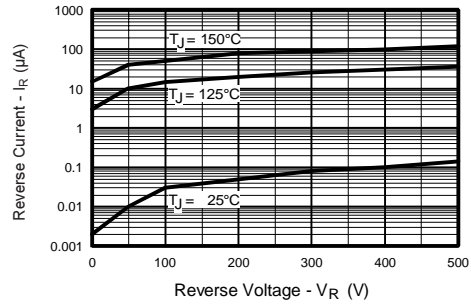

Fig. 2 - Typical Reverse Current vs. Reverse Voltage

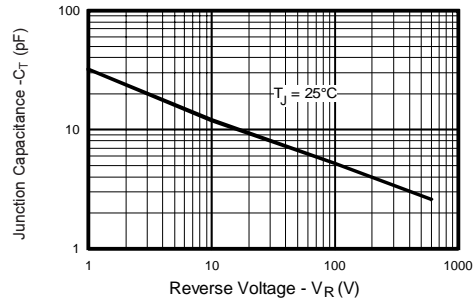

Fig. 3 - Typical Junction Capacitance vs. Reverse Voltage

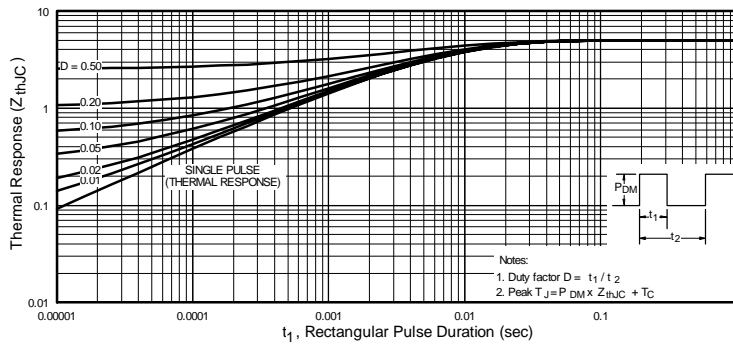

Fig. 4 - Maximum Thermal Impedance Z_{thjC} Characteristics

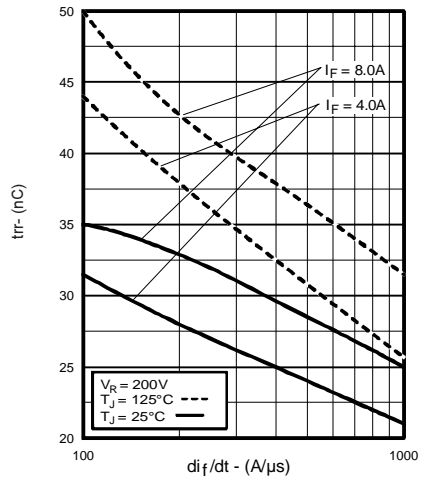

Fig. 5 - Typical Reverse Recovery vs. di_f/dt

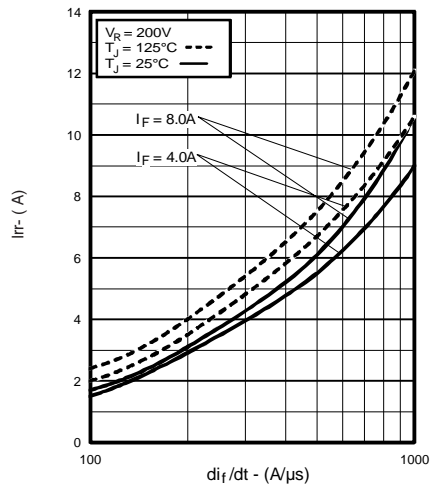

Fig. 6 - Typical Recovery Current vs. di_f/dt

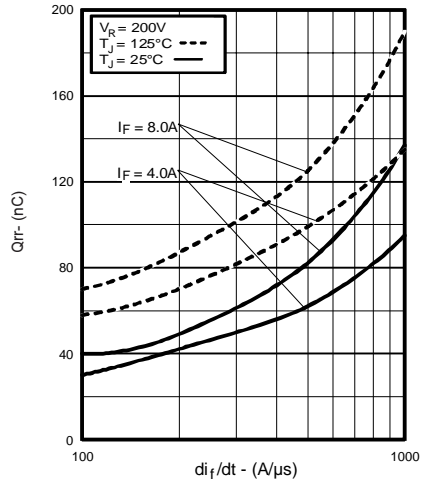

Fig. 7 - Typical Stored Charge vs. di_f/dt

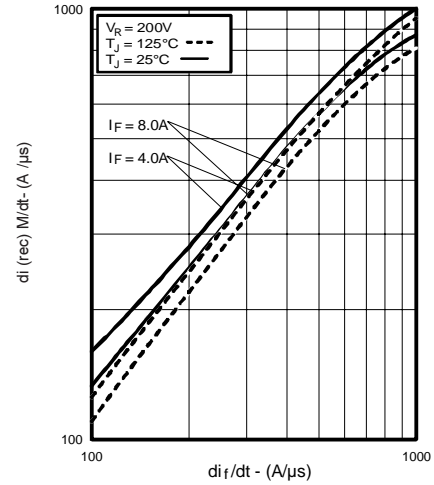

Fig. 8 - Typical $di_{(rec)M}/dt$ vs. di_f/dt

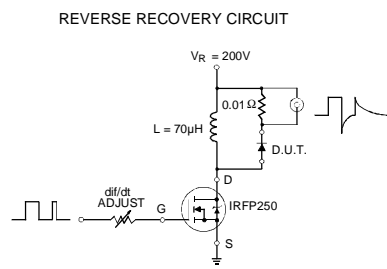

Fig. 9 - Reverse Recovery Parameter Test Circuit

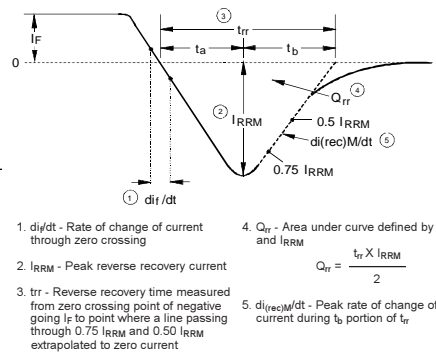
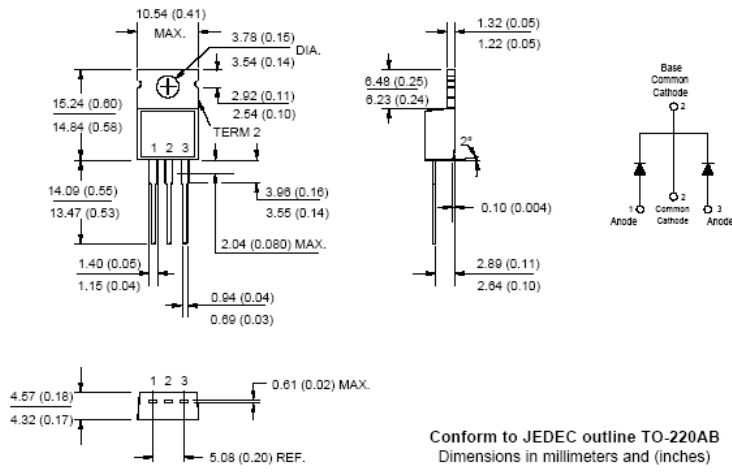

Fig. 10 - Reverse Recovery Waveform and Definitions

HFA08TA60CPbF

TO-220AB Package Outline

Dimensions are shown in millimeters (inches)



Conform to JEDEC outline TO-220AB
Dimensions in millimeters and (inches)

TO-220AB Part Marking Information

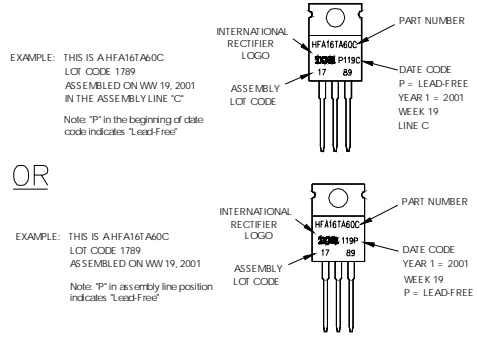

Data and specifications subject to change without notice.



IR WORLD HEADQUARTERS: 233 Kansas St., El Segundo, California 90245, USA Tel: (310) 252-7105
TAC Fax: (310) 252-7903
Visit us at www.irf.com for sales contact information. 10/04