

HA12240FP

Bus Interface Driver/Receiver IC

REJ03F0095-0100Z

Rev.1.0

Dec.01.2003

Description

The HA12240FP is developed to be used as a bus interface driver/receiver IC in automotive audio equipment controllers. It implements a two-wire serial bus.

Functions

- Two-input OR circuit
- Input comparator circuit (3.3 V and 5.0 V available)
- Current output driver circuit
- Receiver input comparator circuit
- Receiver output circuit (Open-collector output)
- Standby circuit

Features

- Supports two data inputs (Pins 1 and 3 are the input pins)
- Comparators with hysteresis characteristics are adopted for the inputs (3.3 V and 5.0 V available)
- Current drive output drivers adopted (Output current: 3.8 mA typical)
- Comparators with hysteresis characteristics are adopted for the receivers
- Wide receiver common-mode input operating range (Common-mode input operating range: 0 to 5 V typical)
- The driver output /the receiver input (pins 5 and 6) can withstand high voltages (Maximum ratings of 18 V)
- Standby functions (standby mode when pin 8 becomes low level)
- Operating power-supply voltage range of $5\text{ V} \pm 0.5\text{ V}$

Block Diagram

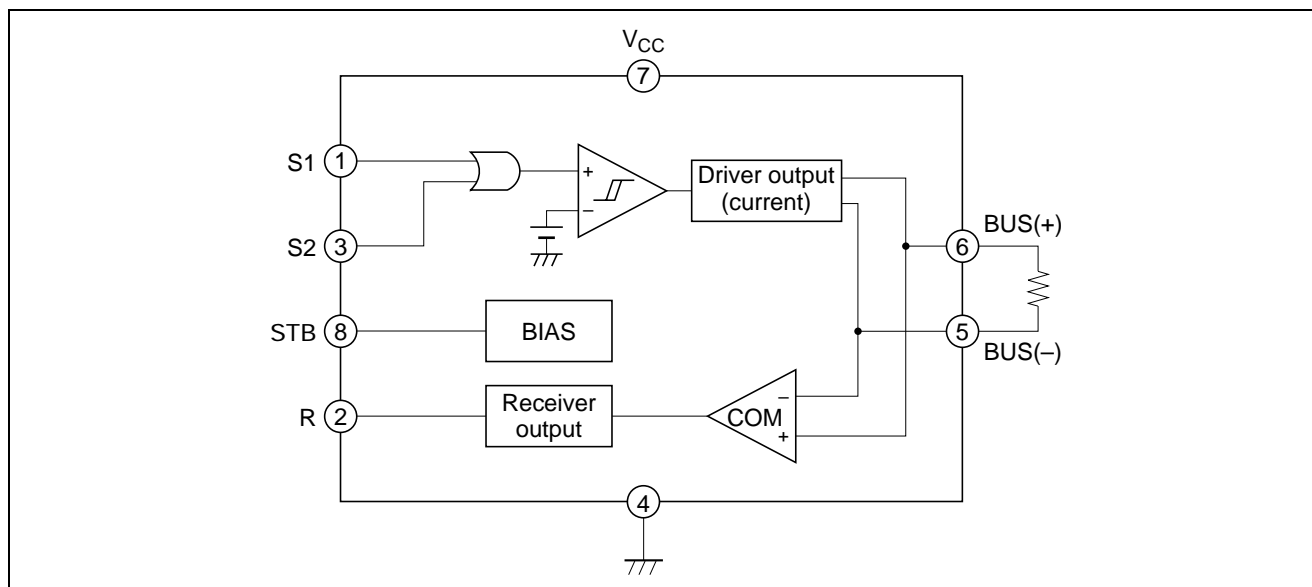

Pin Functions

Pin No.	Symbol	Function	Equivalent Circuit
1	S1	Data input pin 1	
2	R	Receiver output pin	
3	S2	Data input pin 2	
4	GND	GND pin	
5	BUS(-)	Bus output (-), Receiver input (-) pin	
6	BUS(+)	Bus output (+), Receiver input (+) pin	
7	Vcc	Power supply pin	
8	STB	Standby input pin (Lo: ON, Hi: OFF)	

Absolute Maximum Ratings

(Ta = 25°C)

Item	Symbol	Ratings	Unit	Note
Power-supply voltage	V _{CC}	7	V	
Input voltage	V _{IN}	GND–0.3 to V _{CC} +0.3	V	
Bus input voltage	V _{bus}	18	V	
Allowable power dissipation	P _d	400	mW	Ta ≤ 85°C
Operating temperature	T _{opr}	–40 to +85	°C	
Storage temperature	T _{stg}	–55 to +125	°C	

Note: Recommended operating power supply voltage range: 5 V ± 0.5 V

Electrical Characteristics

(V_{CC} = 5.0 V, Ta = 25°C)

Item	Symbol	Min	Typ	Max	Unit	Test Conditions	Test Pin	Test Circuit	
S1	High-level input voltage	V _{IHS1}	2.1	—	—	V	V1 = 0→5 V, V3 = 0 V, V6 – V5 = 110 mV↑	1	Fig. 1
	Low-level input voltage	V _{ILS1}	—	—	1.65	V	V1 = 5→0 V, V3 = 0 V, V6 – V5 = 30 mV↓	1	
	High-level input current	I _{IHS1}	—	—	1	μA	V1 = 5 V, V3 = 0 V	1	
	Low-level input current	I _{ILS1}	—	—	1	μA	V1 = 0 V, V3 = 0 V	1	
S2	High-level input voltage	V _{IHS2}	2.1	—	—	V	V3 = 0→5 V, V1 = 0 V, V6 – V5 = 110 mV↑	3	Fig. 1
	Low-level input voltage	V _{ILS2}	—	—	1.65	V	V3 = 5→0 V, V1 = 0 V, V6 – V5 = 30 mV↓	3	
	High-level input current	I _{IHS2}	—	—	1	μA	V1 = 0 V, V3 = 5 V	3	
	Low-level input current	I _{ILS2}	—	—	1	μA	V1 = 0 V, V3 = 0 V	3	
Driver	High-level output voltage (+)	V _{OHD+}	1.8	2.5	3.2	V	V1 = 5 V, V3 = 0 V	6	Fig. 1
	High-level output voltage (–)	V _{OHD–}	1.8	2.5	3.2	V	V1 = 5 V, V3 = 0 V	5	
	High-level output current	I _{OH}	3.1	3.8	4.5	mA	V1 = 5 V, V3 = 0 V, I _{OH} = ((V _{OHD+}) – (V _{OHD–}))/60	5, 6	
	Low-level output current	I _{OL}	—	—	1	μA	V1 = 0 V, V3 = 0 V, I _{OL} = ((V _{OP+}) – (V _{OP–}))/R _I	5, 6	
Reference operating voltage (+)	V _{OP+}	2.3	2.5	2.7	V	V1 = 0 V, V3 = 0 V	6	Fig. 1	
Reference operating voltage (–)	V _{OP–}	2.3	2.5	2.7	V	V1 = 0 V, V3 = 0 V	5	Fig. 1	
Driver output resistance *1	R _O	5	10	15	kΩ	V1 = 5 V, V3 = 0 V, V8 = 5 V, R _O = 0.6 V/(I6A – I6B)		Fig. 3	

Note: 1. Measure the current when V6 = (V_{OP+}) + 0.3 V to make I6A and measure the current when V6 = (V_{OP+}) – 0.3 V to make I6B.

Electrical Characteristics (cont.)

(V_{CC} = 5.0 V, T_a = 25°C)

Item	Symbol	Min	Typ	Max	Unit	Test Conditions	Test Pin	Test Circuit
Receiver High-level input voltage (1)	V _{IH1}	—	80	110	mV	V6 = 0→5 V, Pin2 = 4 V or more, V1 = 0 V, V3 = 0 V, V5 = 0 V, V _{IH1} = V6 – V5	2	Fig. 2
High-level input voltage (2)	V _{IH2}	—	80	110	mV	V6 = 0→5 V, Pin2 = 4 V or more, V1 = 0 V, V3 = 0 V, V5 = 4.5 V, V _{IH2} = V6 – V5	2	
Low-level input voltage (1)	V _{IL1}	30	50	—	mV	V6 = 5→0 V, Pin2 = 1 V or less, V1 = 0 V, V3 = 0 V, V5 = 0 V, V _{IL1} = V6 – V5	2	
Low-level input voltage (2)	V _{IL2}	30	50	—	mV	V6 = 5→0 V, Pin2 = 1 V or less, V1 = 0 V, V3 = 0 V, V5 = 4.5 V, V _{IL2} = V6 – V5	2	
Input hysteresis voltage (1)	V _{IHYS1}	15	30	45	mV	V _{IHYS1} = V _{IH1} – V _{IL1}		
Input hysteresis voltage (2)	V _{IHYS2}	15	30	45	mV	V _{IHYS2} = V _{IH2} – V _{IL2}		
High-level common-mode input voltage	V _{IHCOM}	4.5	—	—	V	V5 = 0→5 V, V5 when pin2 = 4 V or less, V1 = 0 V, V3 = 0 V, V6 – V5 = 110 mV	5	Fig. 2
Low-level common-mode input voltage	V _{ILCOM}	5	—	—	V	V5 = 0→5 V, V5 when pin2 = 0.3 V or more, V1 = 0 V, V3 = 0 V, V6 – V5 = 30 mV	5	
Input resistance *1	R _I	25	35	45	kΩ	V1 = 0 V, V3 = 0 V, V8 = 5 V, R _I = 0.6 V/(I6A – I6B)	5, 6	Fig. 3
High-level output leakage current 1	I _{OH1}	—	—	1	μA	V1 = 5 V, V3 = 0 V, V8 = 5 V	2	Fig. 1
High-level output leakage current 2	I _{OH2}	—	—	1	μA	V _{CC} = 0 V, V1, V3, V8 = 0 V	2	
High-level output leakage current 3	I _{OH3}	—	—	1	μA	V1, V3, V8 = 0 V	2	
Low-level output voltage 1	V _{OL1}	—	—	0.6	V	V1 = 0 V, V3 = 0 V, V8 = 5 V, Adjust V _{RL} to make apply current = 1.5 mA	2	
Low-level output voltage 2	V _{OL2}	—	—	0.3	V	V1 = 0 V, V3 = 0 V, V8 = 5 V, Adjust V _{RL} to make apply current = 200 μA	2	
Quiescent current 1	I _{CCH}	4.5	6.5	8.5	mA	V1 = 5 V, V3 = 0 V	7	Fig. 1
Quiescent current 2	I _{CCL}	1.05	1.46	1.87	mA	V1 = 0 V, V3 = 0 V	7	Fig. 1
Driver delay time (L→H)	T _{TR1}	—	100	300	ns	See operating waveform figure	5, 6	Fig. 5
Driver delay time (H→L)	T _{TR2}	—	100	300	ns	See operating waveform figure	5, 6	
Receiver delay time (L→H)	T _{DLY1}	—	600	1200	ns	See operating waveform figure	2	
Receiver delay time (H→L)	T _{DLY2}	—	200	600	ns	See operating waveform figure	2	

Note: 1. Measure the current when V6 = (V_{OP+}) + 0.3 V to make I6A and measure the current when V6 = (V_{OP+}) – 0.3 V to make I6B.

Electrical Characteristics (cont.)

 $(V_{CC} = 5.0 \text{ V}, T_a = 25^\circ\text{C})$

Item	Symbol	Min	Typ	Max	Unit	Test Conditions	Test Pin	Test Circuit
Power-supply off output leakage current	I_{OLEAK}	—	—	1	μA	$V_{CC} = 0 \text{ V}, V_8 = 0 \text{ V}, V_6 = 5 \text{ V}, V_1 = 0 \text{ V}, V_3 = 0 \text{ V}, \text{SW1 ON}$	6	Fig. 4
Standby mode current drain	I_{CCstb}	—	—	1	μA	$V_1 = 5 \text{ V}, V_3 = 0 \text{ V}, V_8 = 0 \text{ V}$	7	Fig. 4
Standby mode output leakage current	Istb-Leak	—	—	1	μA	$V_1 = 5 \text{ V}, V_3 = 0 \text{ V}, V_8 = 0 \text{ V}, V_6 = 5 \text{ V}, \text{SW1 ON}$	6	Fig. 4
Standby mode high-level input voltage	VstbH	2	—	—	V	$V_8 = 0 \rightarrow 5 \text{ V}, V_8$ when pin5,6 = 2.3 V or more, $V_1 = 0 \text{ V}, V_3 = 0 \text{ V}$	8	Fig. 1
Standby mode low-level input voltage	VstbL	—	—	0.9	V	$V_8 = 5 \rightarrow 0 \text{ V}, V_8$ when current flowing into pin7 = $1 \mu\text{A}$ or less, $V_1 = 5 \text{ V}, V_3 = 0 \text{ V}$	8	Fig. 1
Standby mode high-level input current	IstbH	—	50	100	μA	$V_1 = 5 \text{ V}, V_3 = 0 \text{ V}, V_8 = 5 \text{ V}$	8	Fig. 1
Standby mode low-level input current	IstbL	—	—	1	μA	$V_1 = 5 \text{ V}, V_3 = 0 \text{ V}, V_8 = 0 \text{ V}$	8	Fig. 1

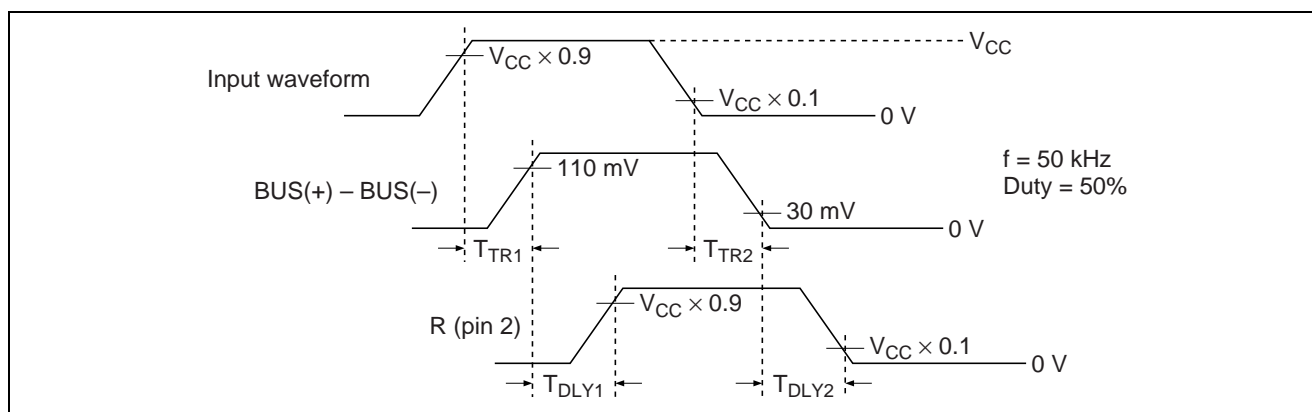

Input/Output Waveform Figure

Test Circuits

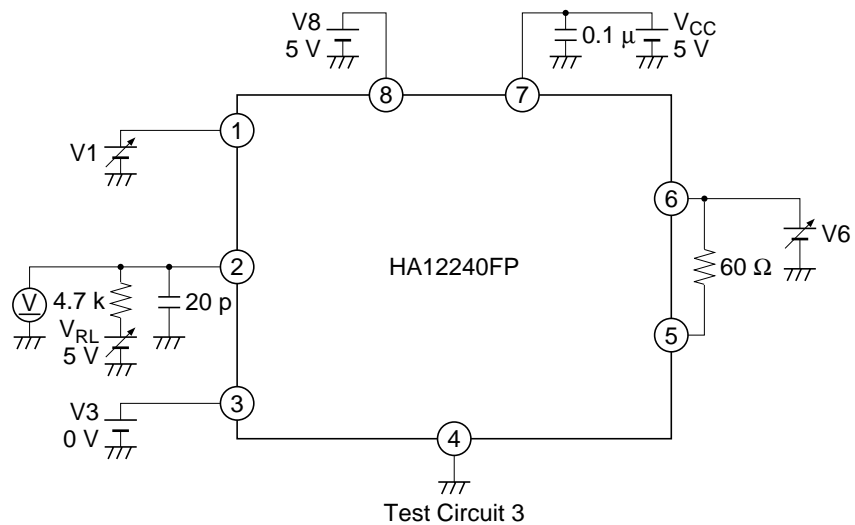
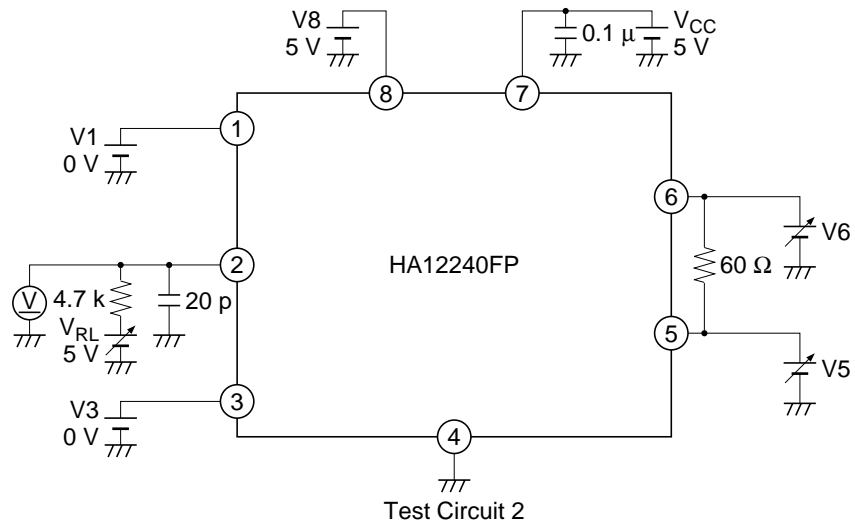
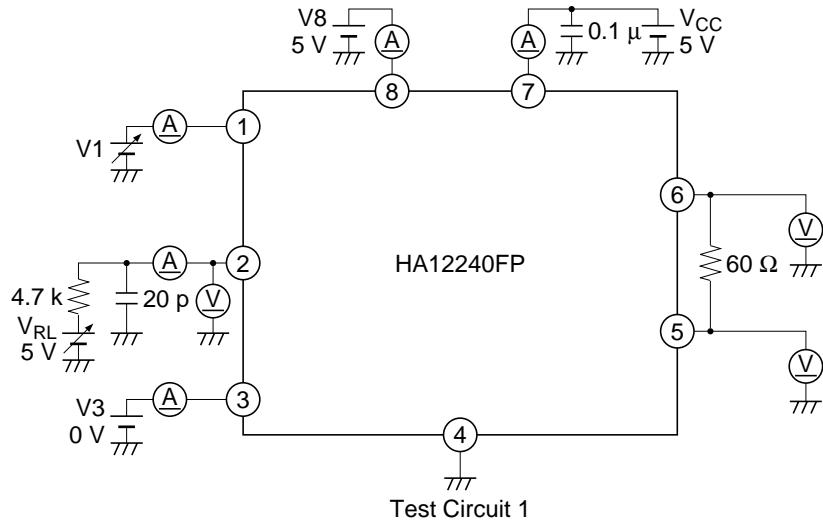

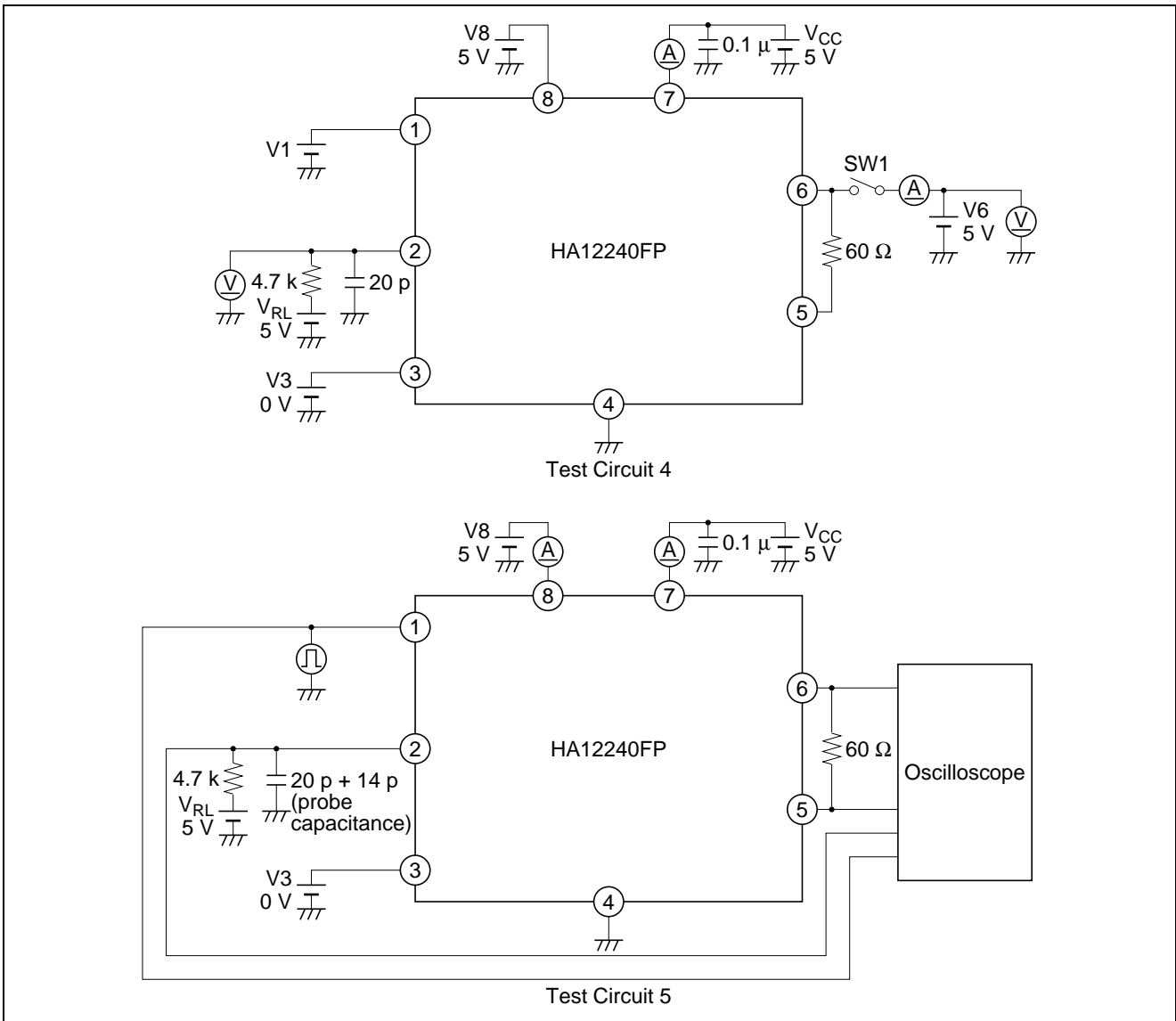

Operating Waveforms

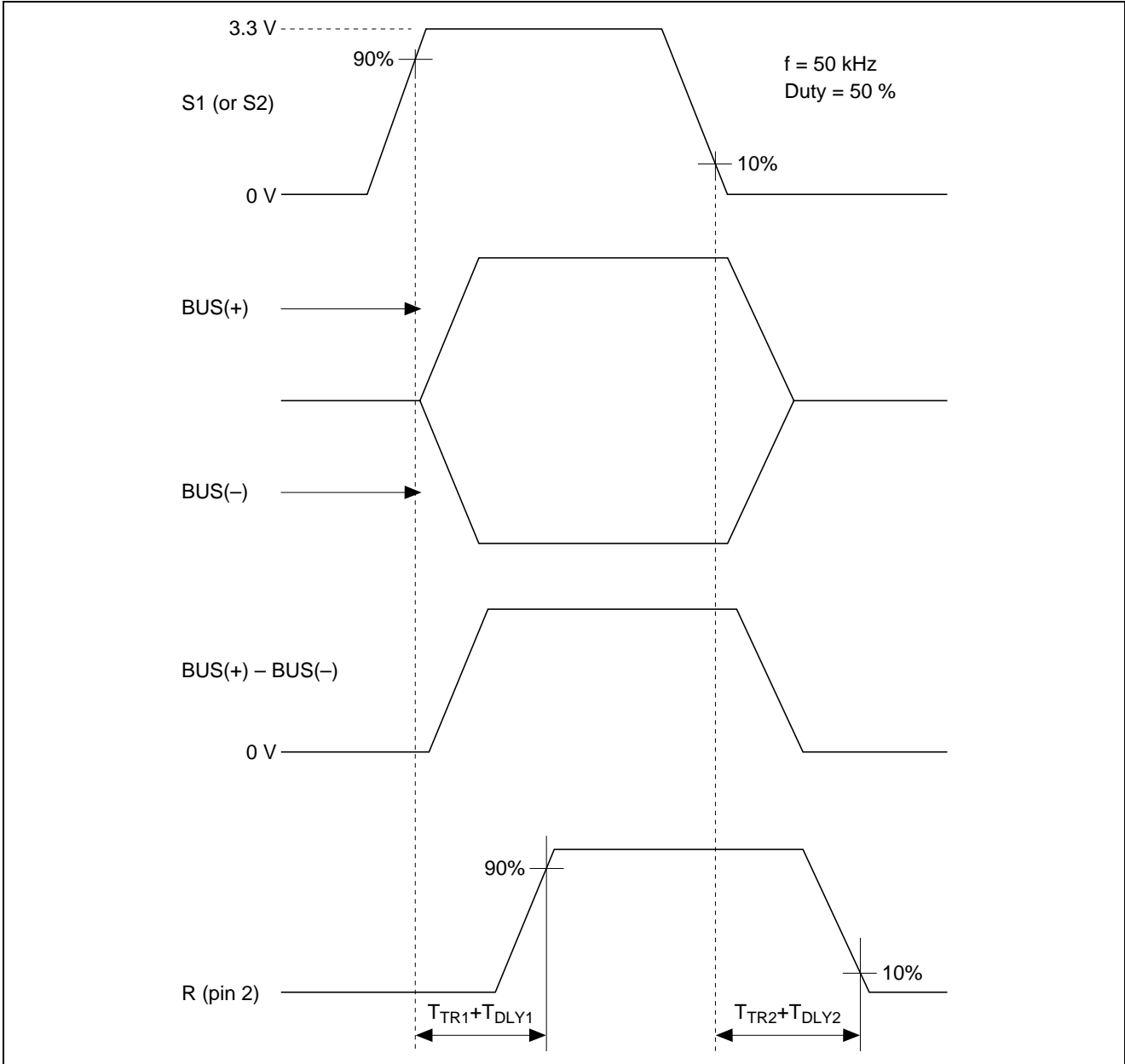

Main Characteristics

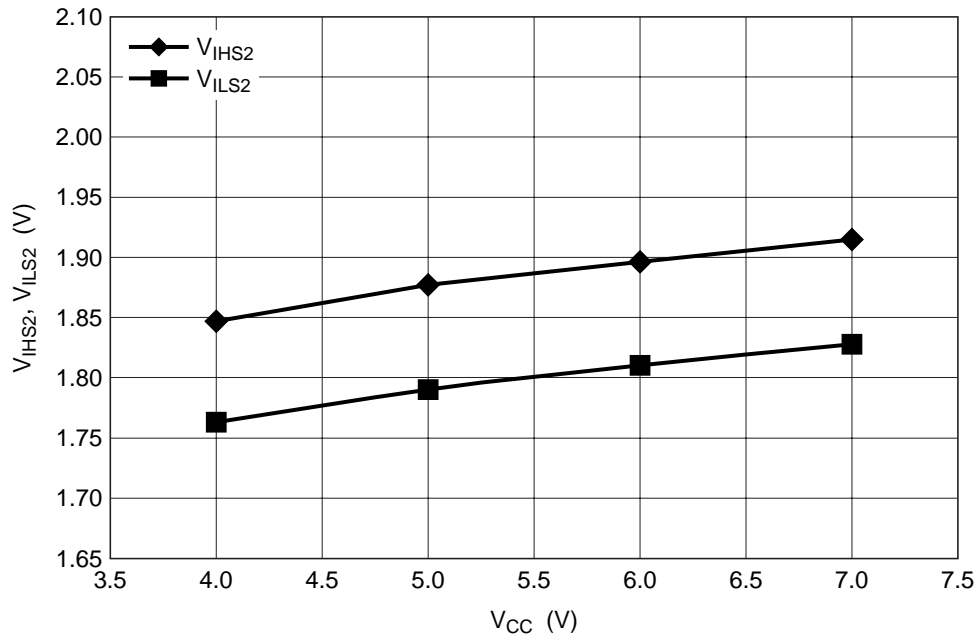
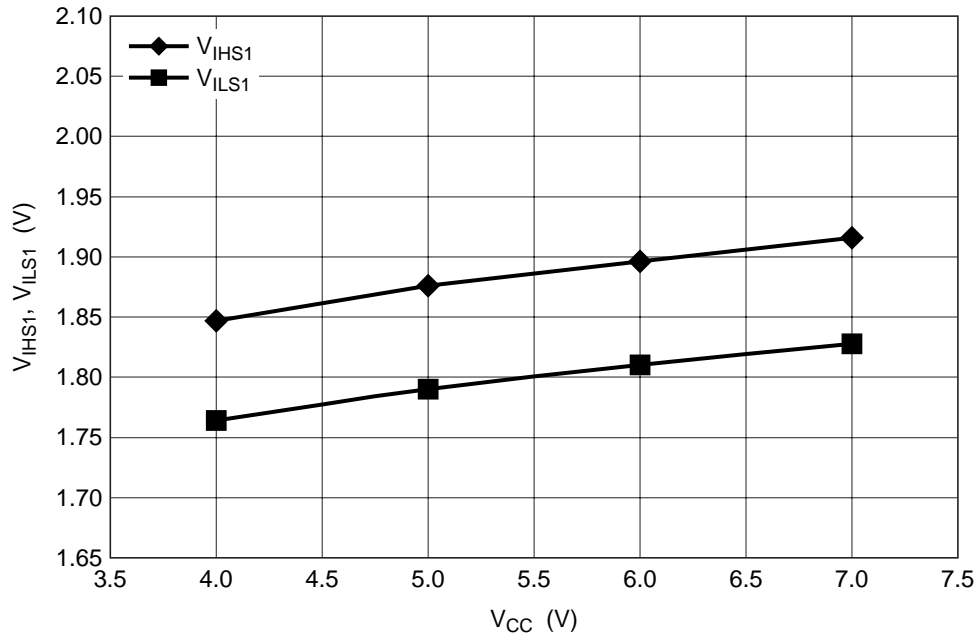

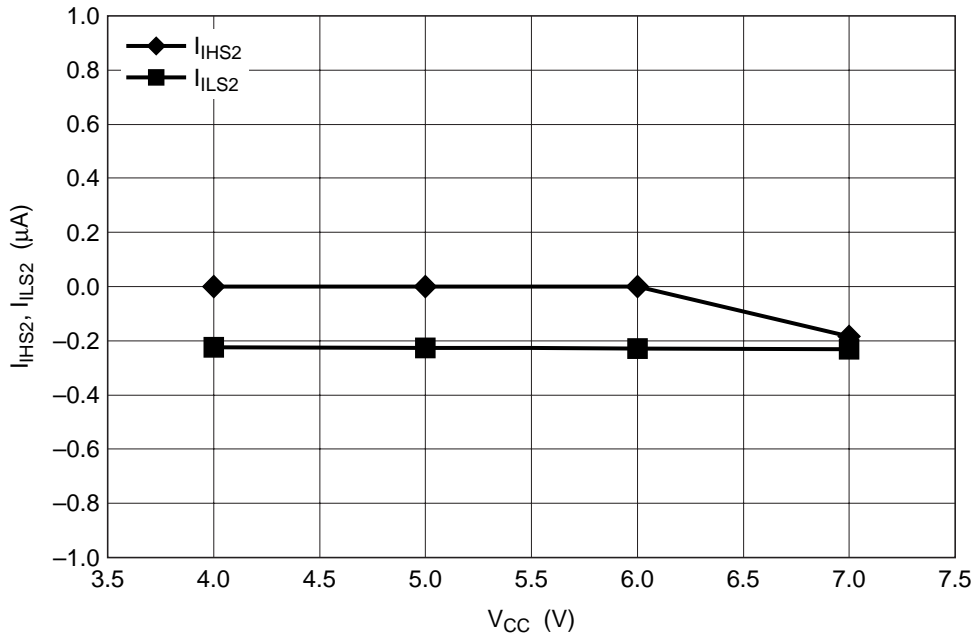
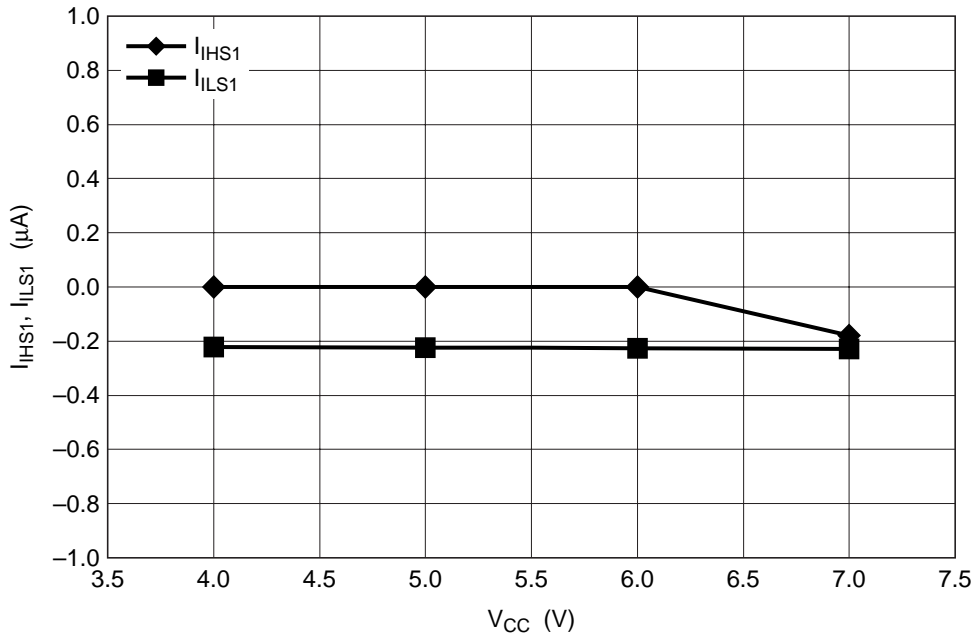

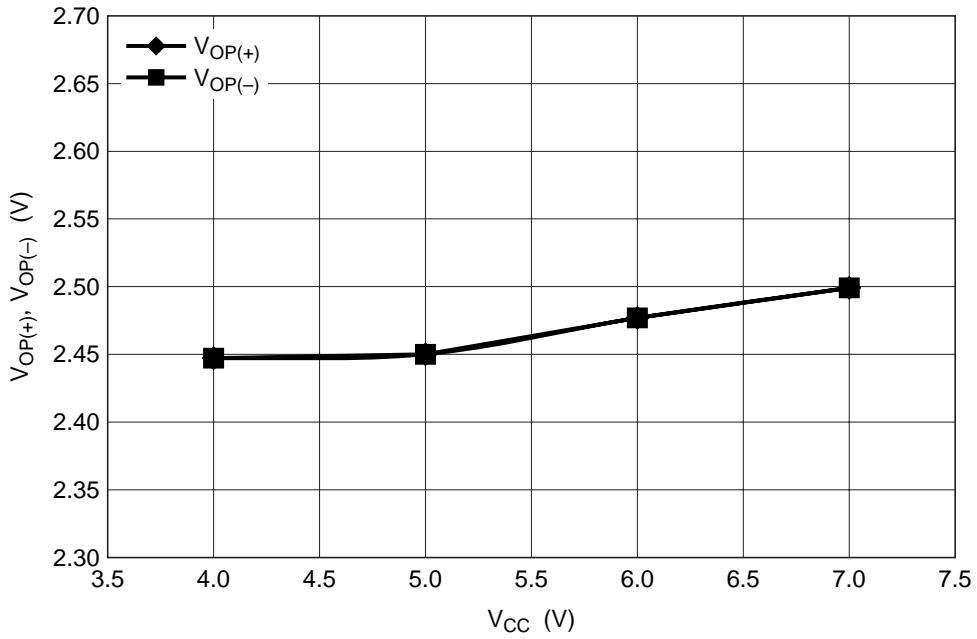
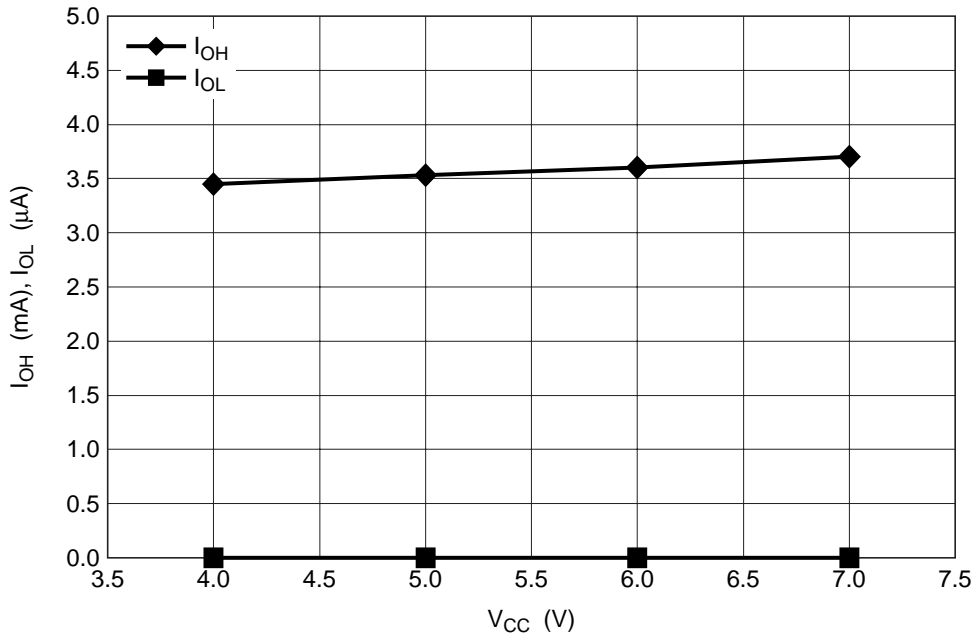

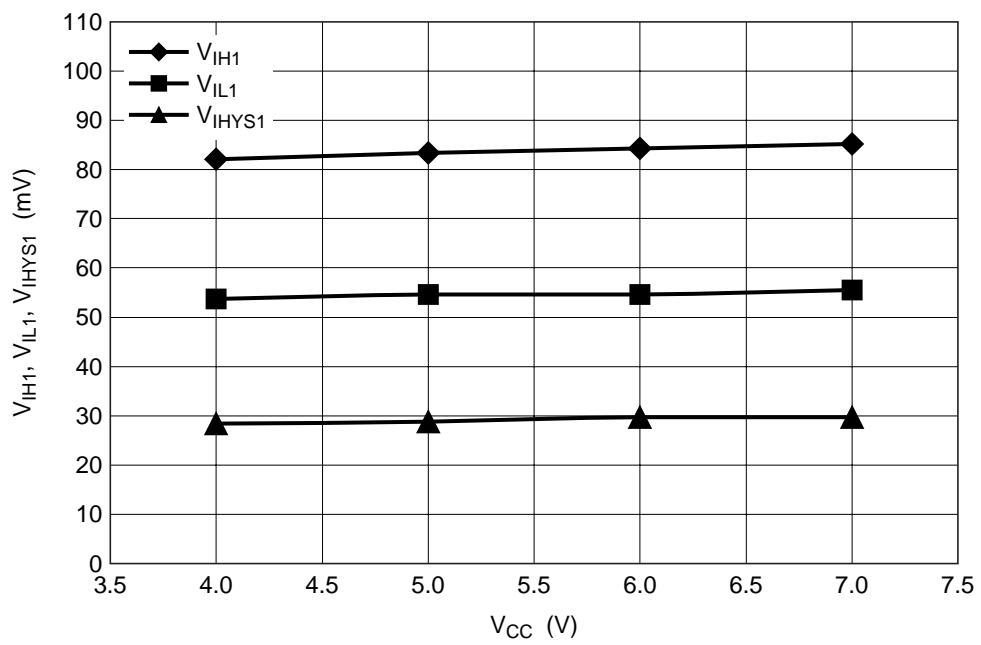
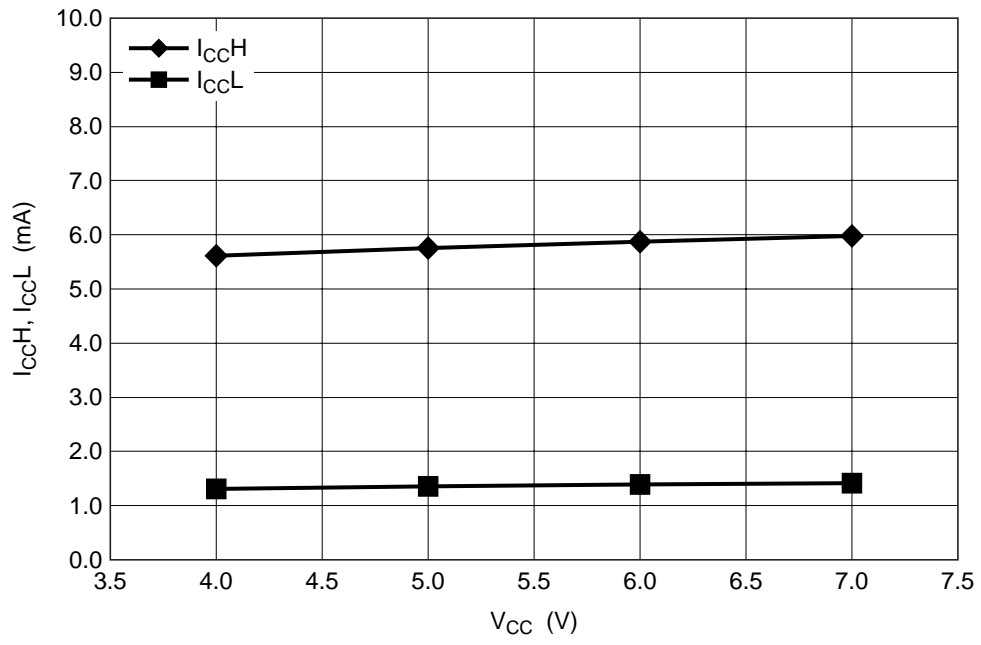

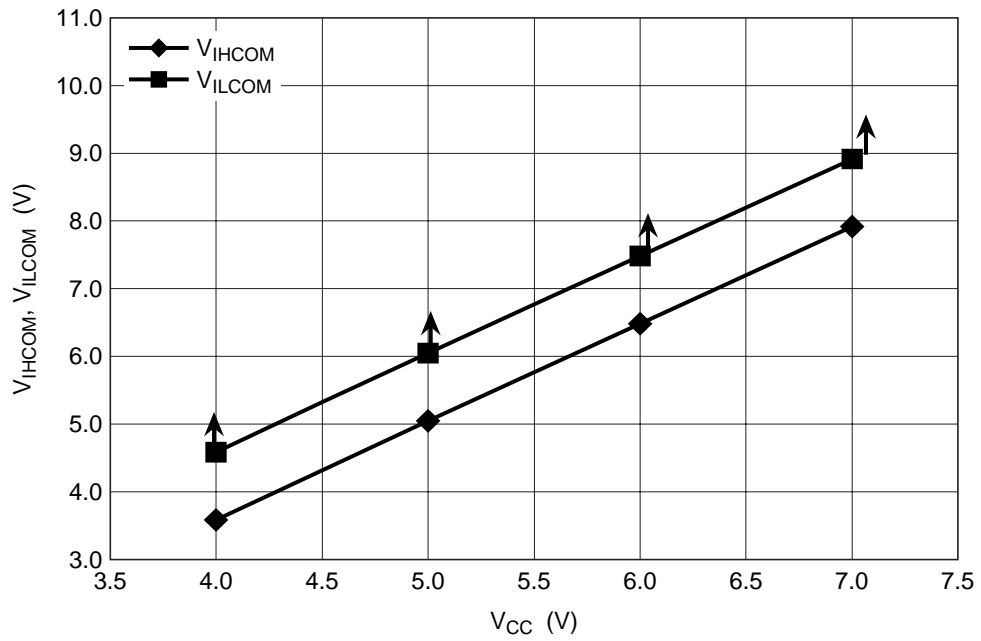
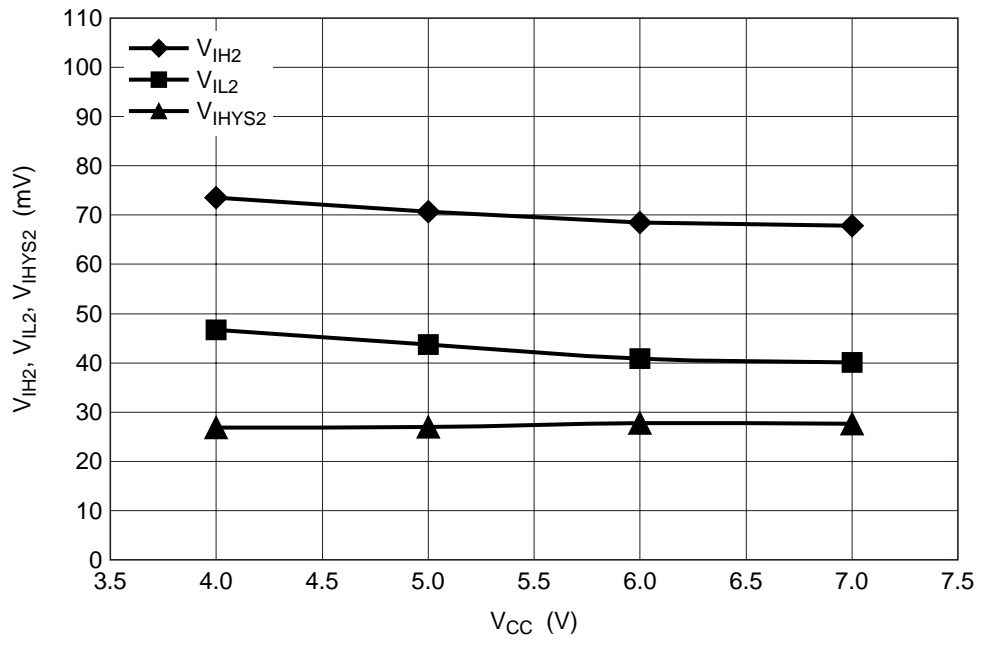

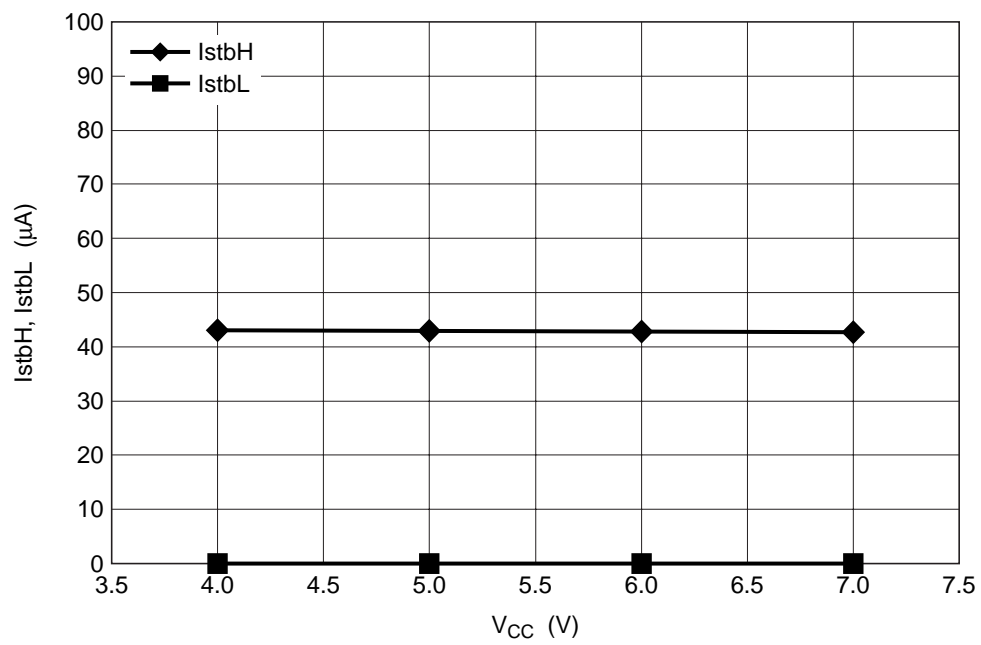
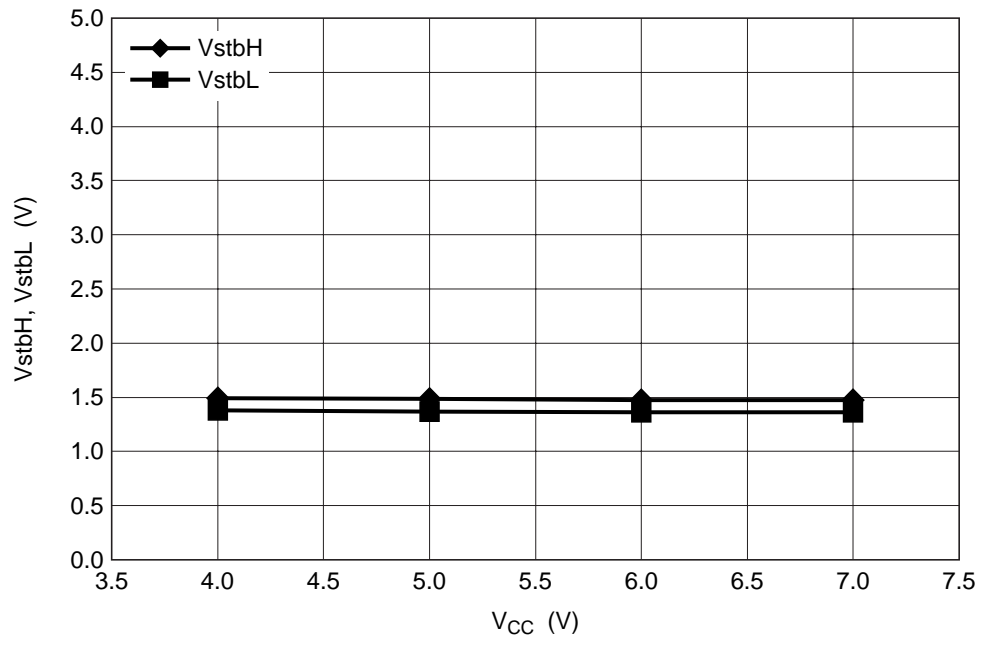

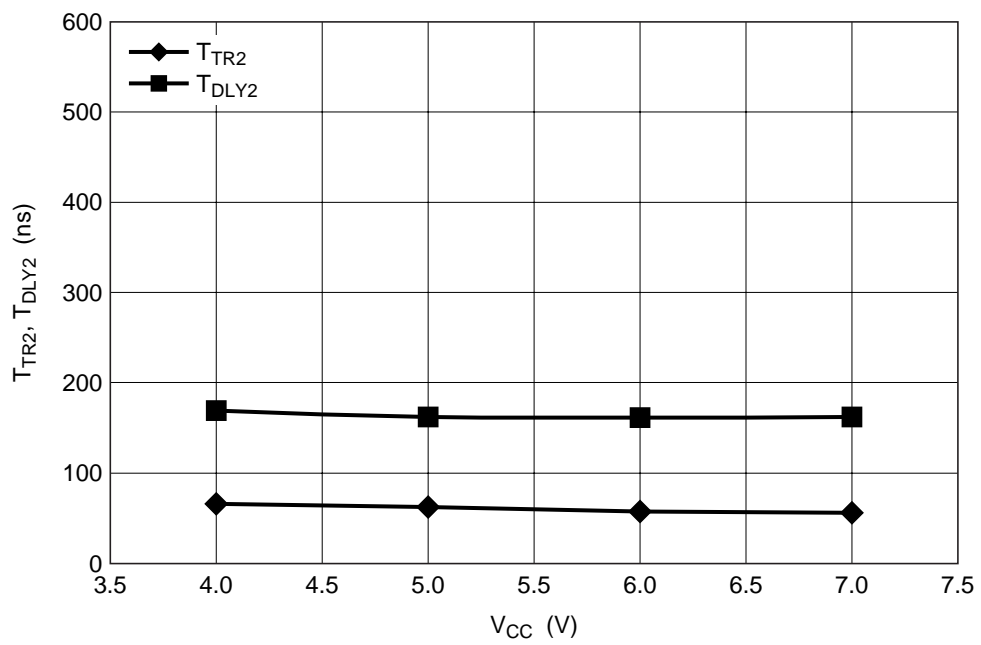
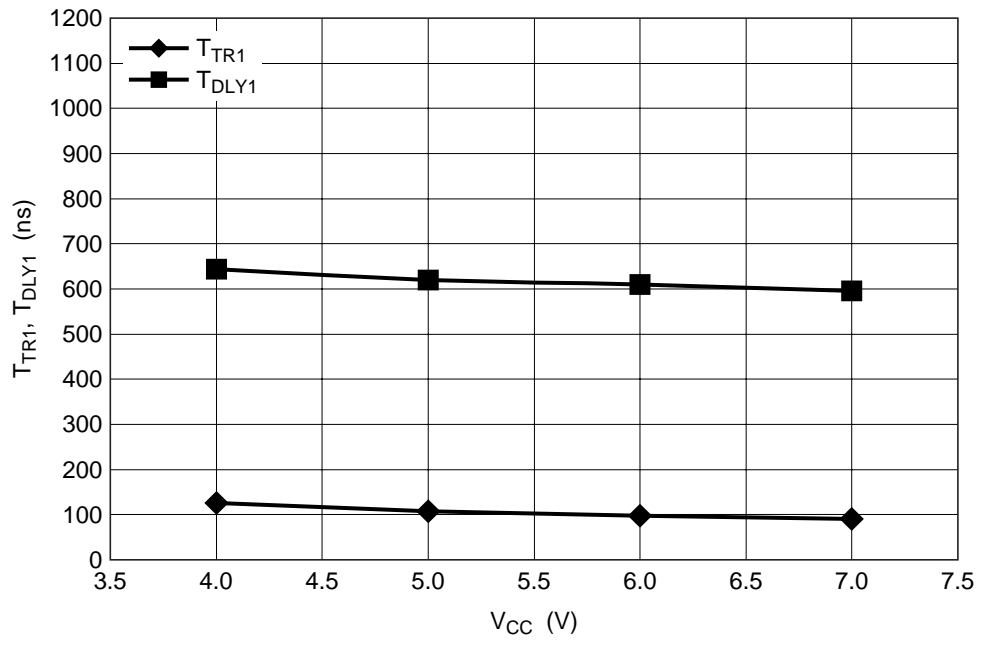

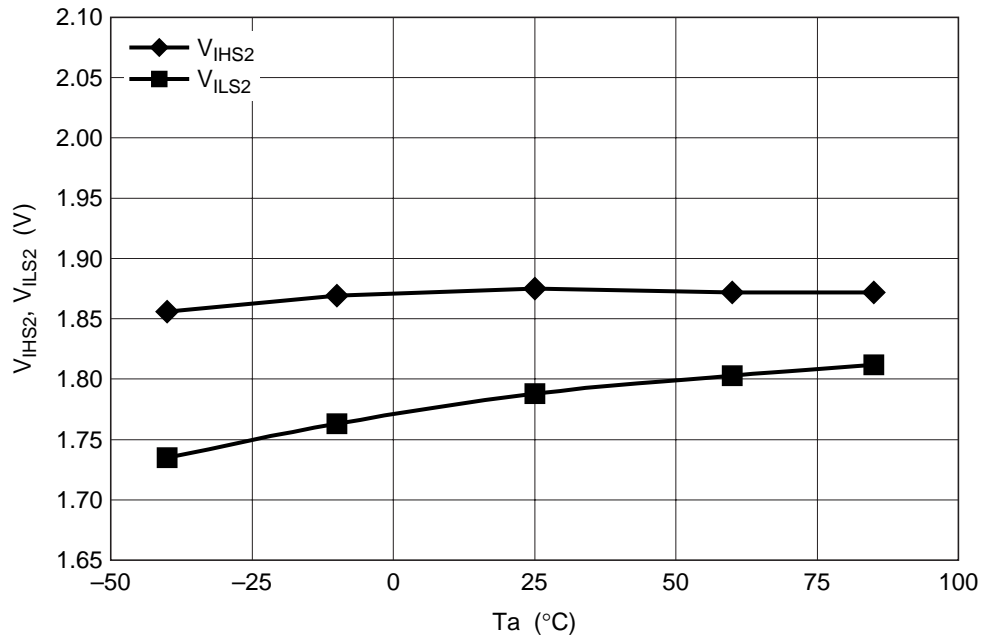
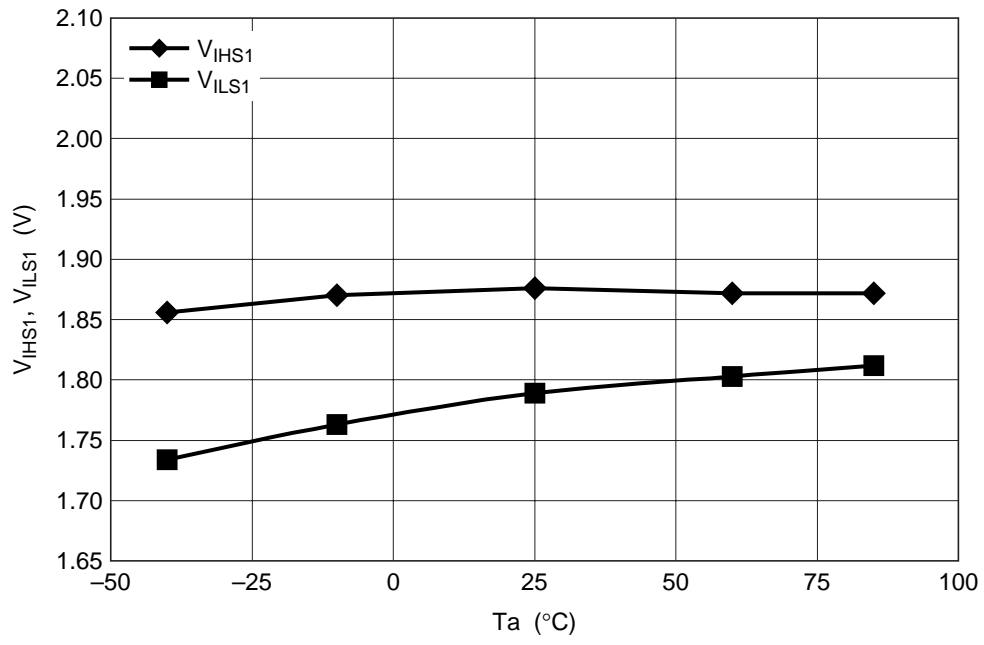

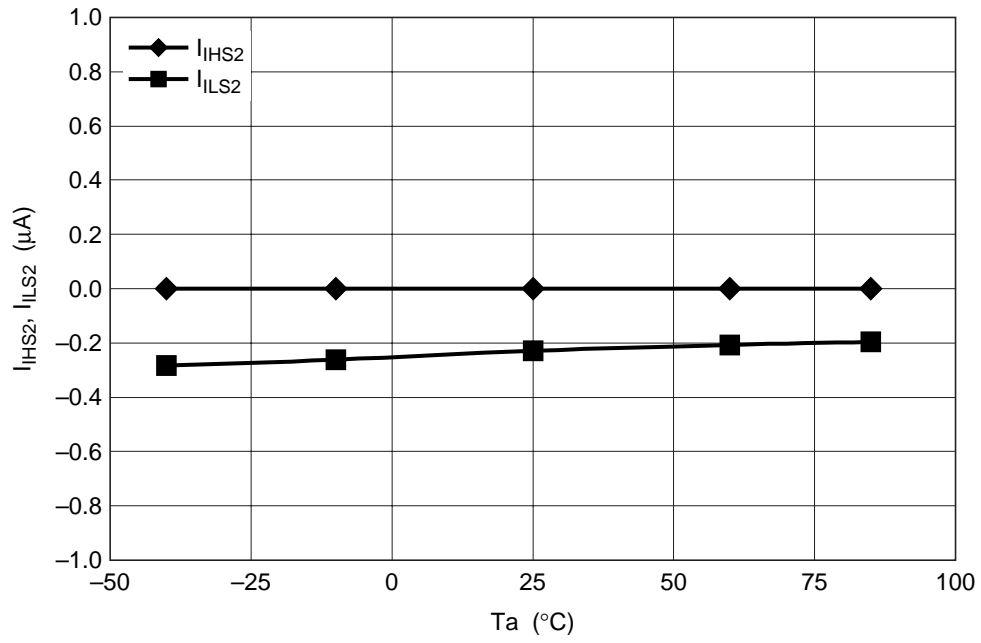
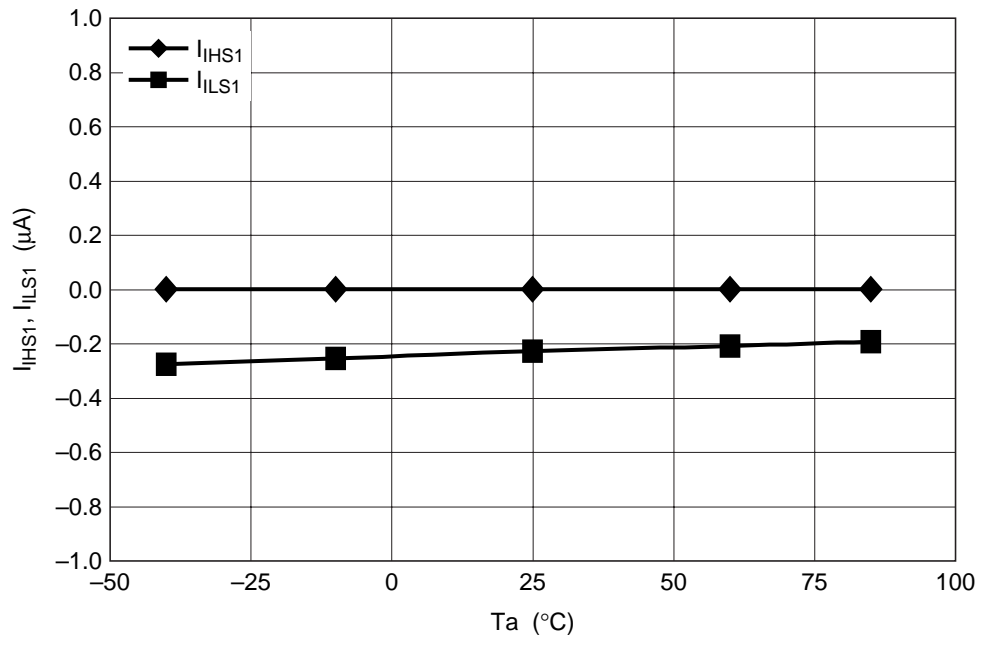

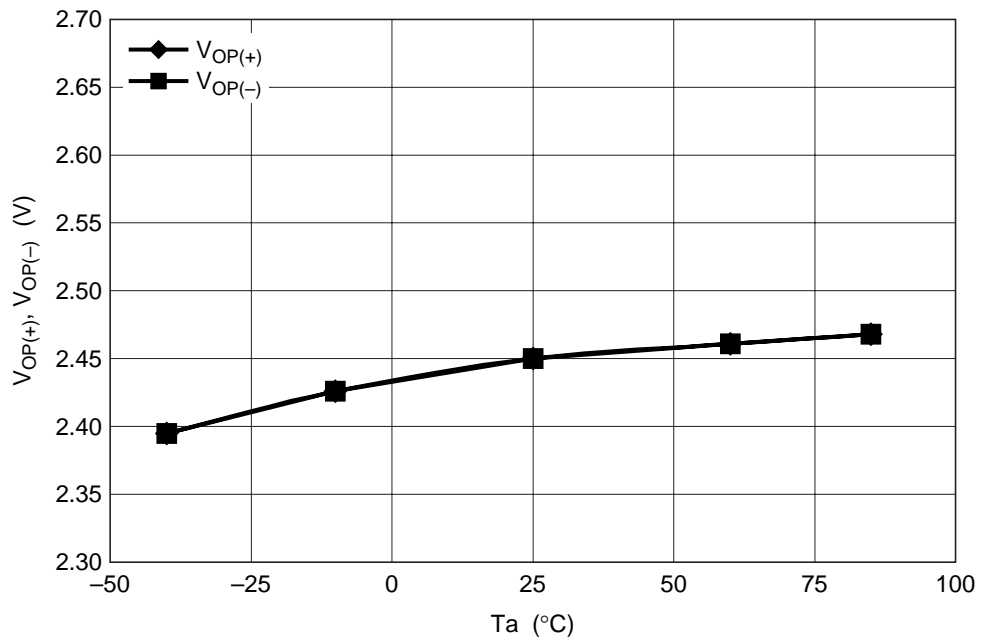
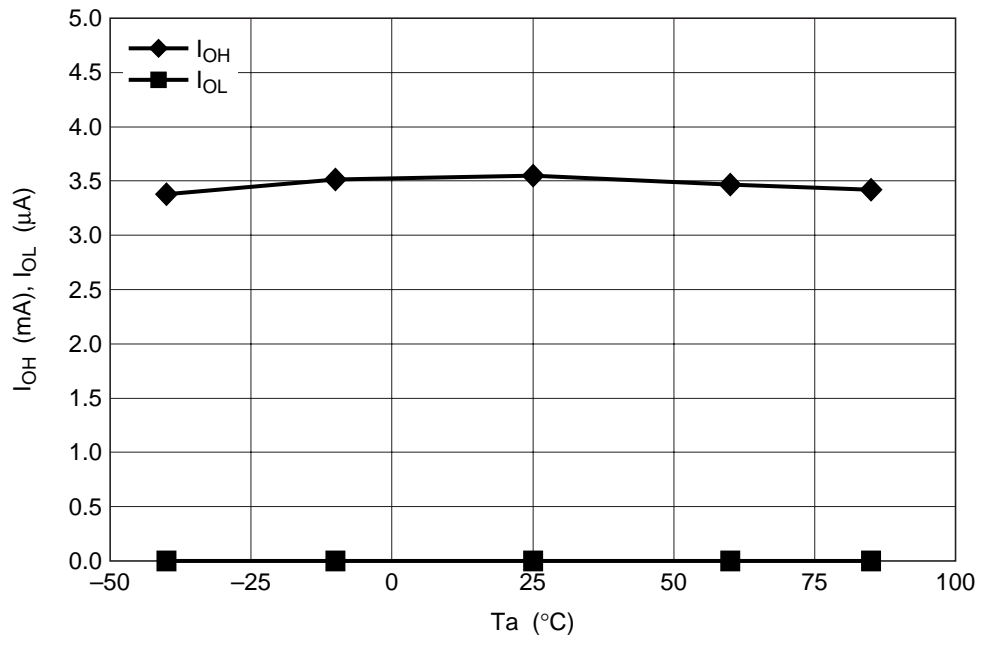

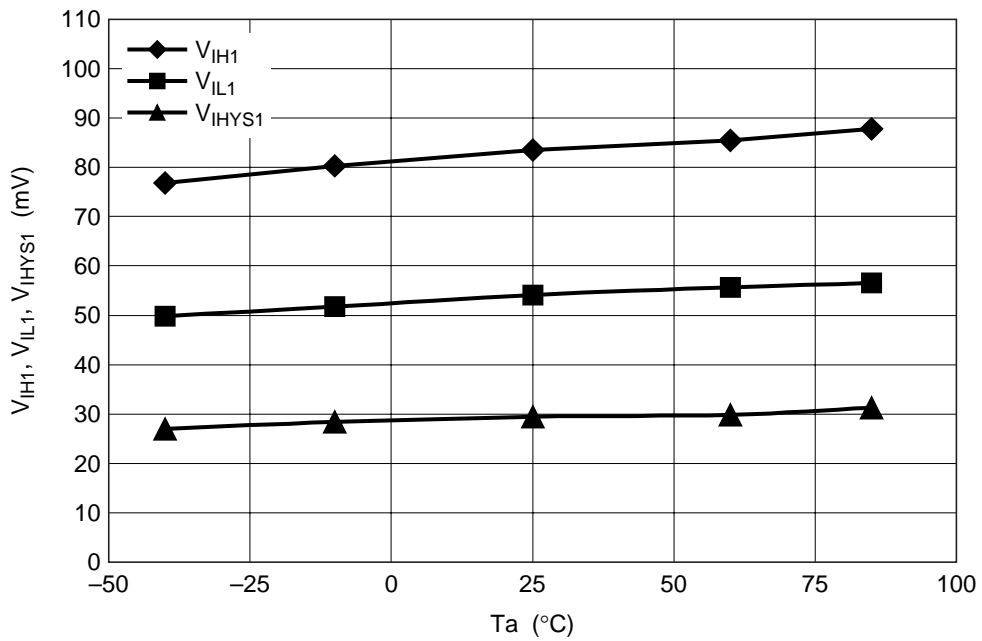
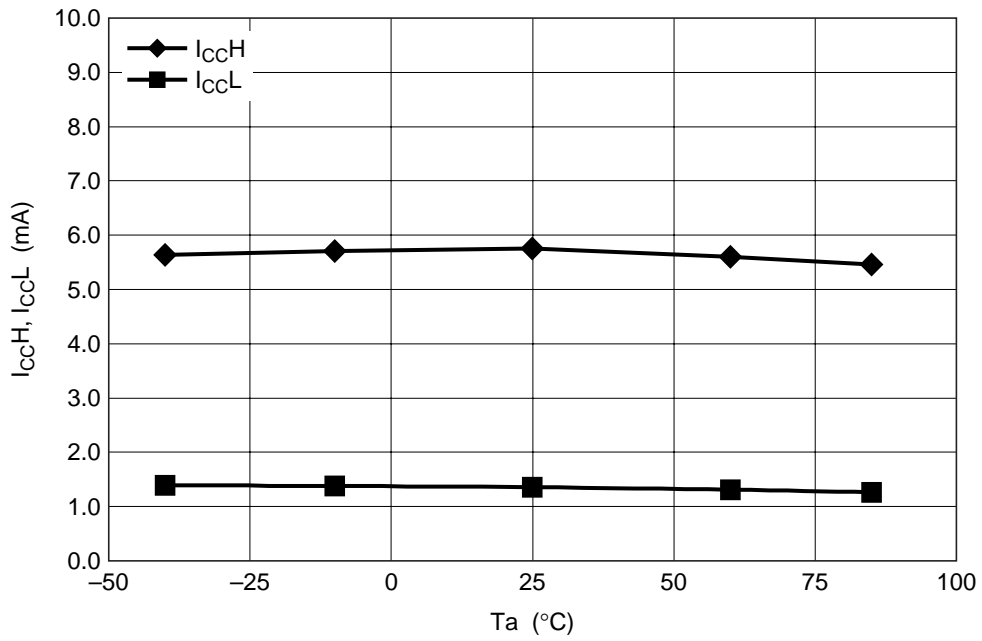

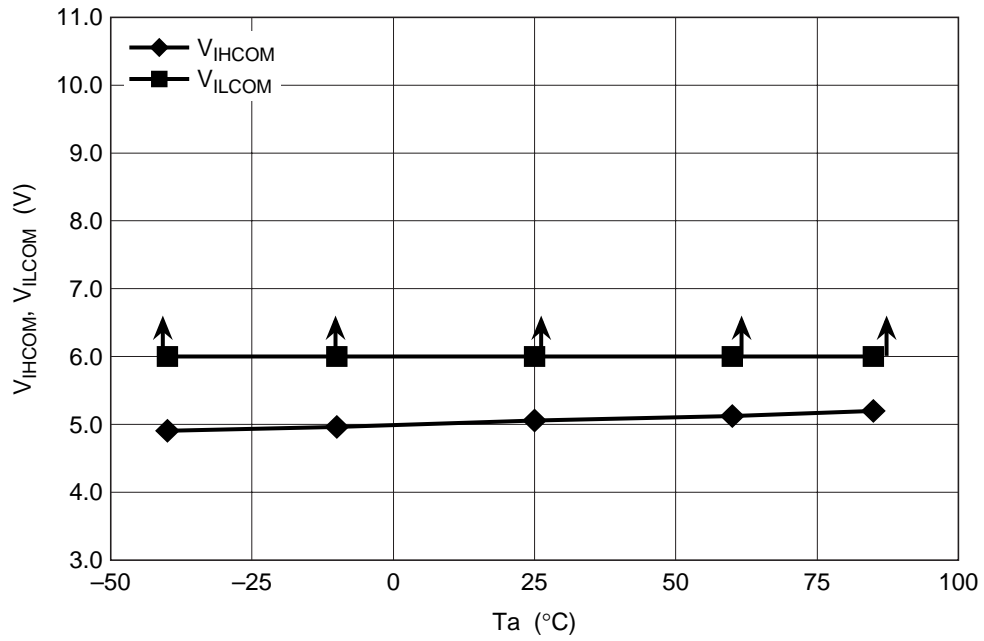
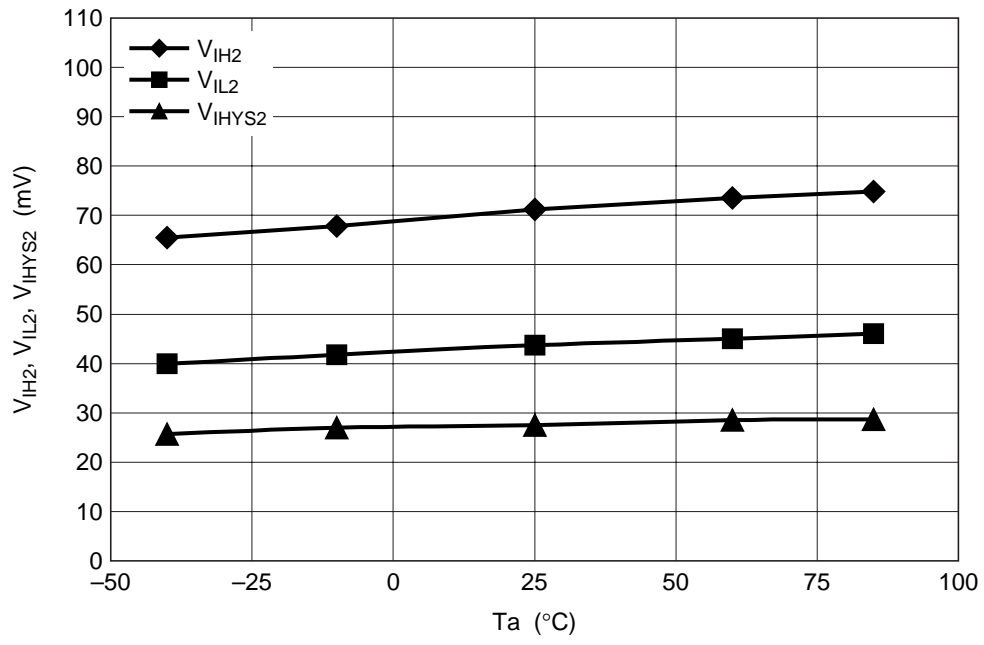

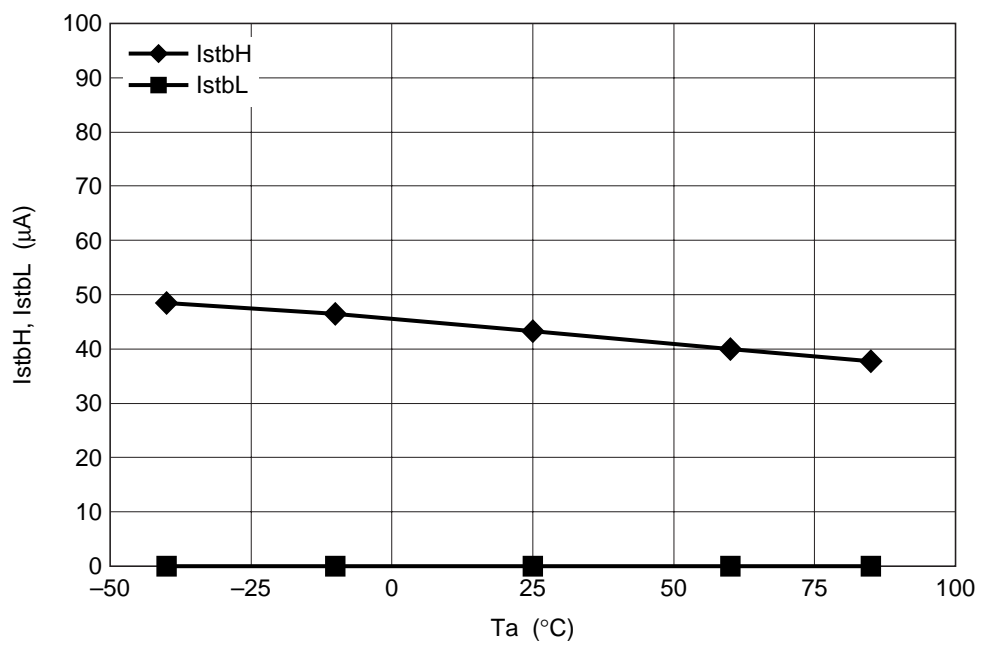
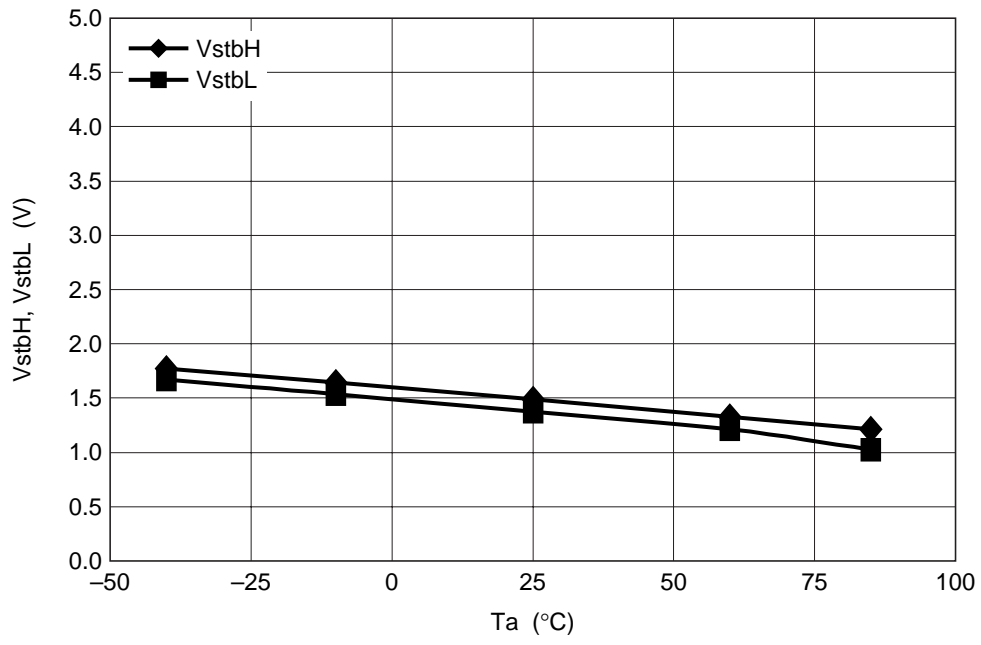

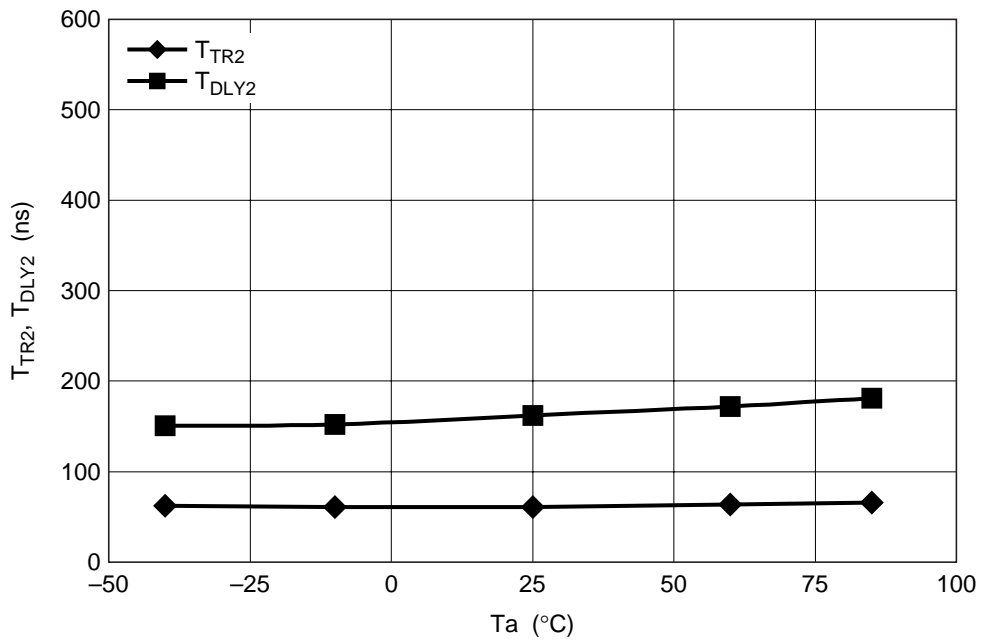
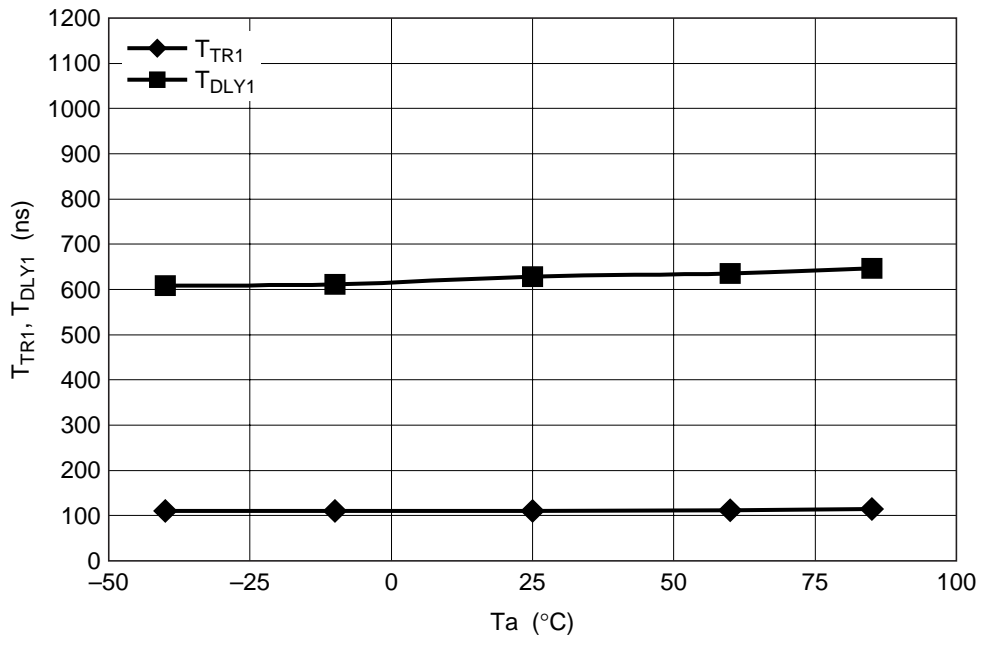

Package Dimensions

Unit: mm

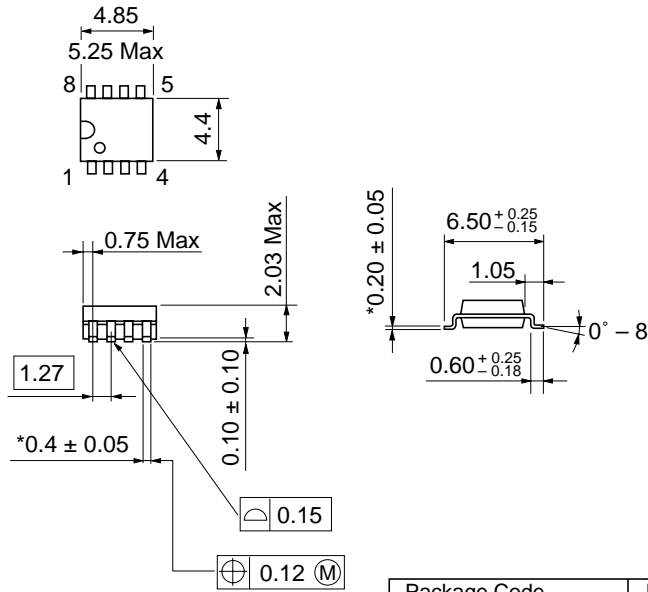

*Dimension including the plating thickness

Package Code	FP-8DGV
JEDEC	—
JEITA	Conforms
Mass (reference value)	0.10 g

RENESAS Technology Corp. Sales Strategic Planning Div. Nippon Bldg., 2-6-2, Ohte-machi, Chiyoda-ku, Tokyo 100-0004, Japan

Keep safety first in your circuit designs!

1. Renesas Technology Corp. puts the maximum effort into making semiconductor products better and more reliable, but there is always the possibility that trouble may occur with them. Trouble with semiconductors may lead to personal injury, fire or property damage.
Remember to give due consideration to safety when making your circuit designs, with appropriate measures such as (i) placement of substitutive, auxiliary circuits, (ii) use of nonflammable material or (iii) prevention against any malfunction or mishap.

Notes regarding these materials

1. These materials are intended as a reference to assist our customers in the selection of the Renesas Technology Corp. product best suited to the customer's application; they do not convey any license under any intellectual property rights, or any other rights, belonging to Renesas Technology Corp. or a third party.
 2. Renesas Technology Corp. assumes no responsibility for any damage, or infringement of any third-party's rights, originating in the use of any product data, diagrams, charts, programs, algorithms, or circuit application examples contained in these materials.
 3. All information contained in these materials, including product data, diagrams, charts, programs and algorithms represents information on products at the time of publication of these materials, and are subject to change by Renesas Technology Corp. without notice due to product improvements or other reasons. It is therefore recommended that customers contact Renesas Technology Corp. or an authorized Renesas Technology Corp. product distributor for the latest product information before purchasing a product listed herein.
The information described here may contain technical inaccuracies or typographical errors.
Renesas Technology Corp. assumes no responsibility for any damage, liability, or other loss rising from these inaccuracies or errors.
Please also pay attention to information published by Renesas Technology Corp. by various means, including the Renesas Technology Corp. Semiconductor home page (<http://www.renesas.com>).
 4. When using any or all of the information contained in these materials, including product data, diagrams, charts, programs, and algorithms, please be sure to evaluate all information as a total system before making a final decision on the applicability of the information and products. Renesas Technology Corp. assumes no responsibility for any damage, liability or other loss resulting from the information contained herein.
 5. Renesas Technology Corp. semiconductors are not designed or manufactured for use in a device or system that is used under circumstances in which human life is potentially at stake. Please contact Renesas Technology Corp. or an authorized Renesas Technology Corp. product distributor when considering the use of a product contained herein for any specific purposes, such as apparatus or systems for transportation, vehicular, medical, aerospace, nuclear, or undersea repeater use.
 6. The prior written approval of Renesas Technology Corp. is necessary to reprint or reproduce in whole or in part these materials.
 7. If these products or technologies are subject to the Japanese export control restrictions, they must be exported under a license from the Japanese government and cannot be imported into a country other than the approved destination.
Any diversion or reexport contrary to the export control laws and regulations of Japan and/or the country of destination is prohibited.
 8. Please contact Renesas Technology Corp. for further details on these materials or the products contained therein.
-



RENESAS SALES OFFICES

<http://www.renesas.com>

Renesas Technology America, Inc.
450 Holger Way, San Jose, CA 95134-1368, U.S.A
Tel: <1> (408) 382-7500 Fax: <1> (408) 382-7501

Renesas Technology Europe Limited.
Dukes Meadow, Millboard Road, Bourne End, Buckinghamshire, SL8 5FH, United Kingdom
Tel: <44> (1628) 585 100, Fax: <44> (1628) 585 900

Renesas Technology Europe GmbH
Dornacher Str. 3, D-85622 Feldkirchen, Germany
Tel: <49> (89) 380 70 0, Fax: <49> (89) 929 30 11

Renesas Technology Hong Kong Ltd.
7/F., North Tower, World Finance Centre, Harbour City, Canton Road, Hong Kong
Tel: <852> 2265-6688, Fax: <852> 2375-6836

Renesas Technology Taiwan Co., Ltd.
FL 10, #99, Fu-Hsing N. Rd., Taipei, Taiwan
Tel: <886> (2) 2715-2888, Fax: <886> (2) 2713-2999

Renesas Technology (Shanghai) Co., Ltd.
26/F., Ruijin Building, No.205 Maoming Road (S), Shanghai 200020, China
Tel: <86> (21) 6472-1001, Fax: <86> (21) 6415-2952

Renesas Technology Singapore Pte. Ltd.
1, Harbour Front Avenue, #06-10, Keppel Bay Tower, Singapore 098632
Tel: <65> 6213-0200, Fax: <65> 6278-8001