

MITSUBISHI GCT(Gate Commutated Turn-off) THYRISTOR UNIT

GCU08BA-130

HIGH POWER INVERTER USE
PRESS PACK TYPE

GCU08BA-130

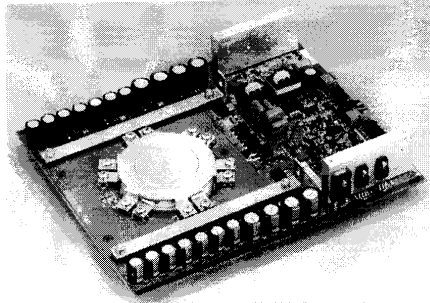

- Symmetrical GCT unit
- GCT and gate driver are connected
- I_{TQRM} : Repetitive controllible on state current.....800A
- $I_{T(AV)}$: Average on-state current.....330A
- V_{DRM} : Repetitive peak off state voltage6500V
- V_{RRM} : Repetitive peak reverse voltage6500V
- T_j : Operation junction temperature.....125deg

APPLICATION

Current source inverters, DC choppers, Induction heaters, DC to DC converter

GCT PART(Type name: FGC800B-130DS)

Symbol	Parameter	Condition	Voltage class	Unit
V_{RRM}	Repetitive peak reverse voltage	-	6500	V
V_{RSM}	Non-repetitive peak reverse voltage	-	6500	V
V_{DRM}	Repetitive peak off state voltage	$V_{GK}=-2V$	6500	V
V_{DSM}	Non-repetitive peak off state voltage	$V_{GK}=-2V$	6500	V
V_{LTD5}	Long term DC stability voltage	$V_{GK}=-2V, \lambda=100Fit$	3600	V

Symbol	Parameter	Condition	Ratings	Unit
I_{TQRM}	Repetitive controllible on state current	$V_{DM}=3/4V_{DRM}, V_D=3000V, T_j=25/125deg$ $L_c=0.3\mu H, \text{ With GU-D08 (See Fig.1,3)}$	800	A
$I_{T(RMS)}$	RMS on-state current	Applied for all condition angles	520	A
$I_{T(AV)}$	Average on-state current	$f=60Hz, \text{sinewave } \theta=180^\circ, T_f=62deg$	330	A
I_{TSM}	Surge on-state current	One half cycle at 60Hz, $T_j=125deg$ start	4.8	kA
I^2t	Current squared, time integration		9.6×10^4	A ² s
di/dt	Critical rate of rise of on state current	$I_f=800A, V_D=3000V, T_j=25/125deg$ $C_s=0.1\mu F, R_s=10ohm, f=60Hz$ With GU-D08 (See Fig.1,2)	1000	A/ μ s
di/dt	Critical rate of rise of reverse recovery current	$I_f=800A, V_R=3000V, T_j=25/125deg$ $C_s=0.1\mu F, R_s=10ohm$ (See Fig.4,5)	1000	A/ μ s
V_{FGM}	Peak forward gate voltage		10	V
V_{RGM}	peak reverse gate voltage		21	V
I_{FGM}	Peak forward gate current		500	A
I_{RGM}	Peak reverse gate current		800	A
P_{FGM}	Peak forward gate power dissipation		5	kW
P_{RGM}	Peak reverse gate power dissipation		17	kW
$P_{FG(AV)}$	Average forward gate power dissipation		100	W
$P_{RG(AV)}$	Average reverse gate power dissipation		120	W
T_j	Operation junction temperature		-20~125	°C
T_{stg}	Storage temperature		-20~150	°C
-	Mounting force required	(Recommended value 13 kN)	11.1 ~ 15.8	kN
-	Weight	Typical value 530g	-	g

MITSUBISHI GCT(Gate Commutated Turn-off) THYRISTOR UNIT

GCU08BA-130

HIGH POWER INVERTER USE
PRESS PACK TYPE

Symbol	Parameter	Condition	Limits			Unit
			Min	Typ	Max	
V _{TM}	On-state voltage	I _T =400A, T _j =125deg	—	—	5.5	V
I _{RRM}	Repetitive peak reverse current	V _{RM} =6500V, T _j =125deg	—	—	250	mA
I _{DRM}	Repetitive peak off state current	V _{DM} =6500V, V _{GK} =-2V, T _j =125deg	—	—	100	mA
I _{GDM}	Reverse gate current	V _{RG} =21V, T _j =125deg	—	—	40	mA
dv/dt	Critical rate of rise of off state voltage	V _D =3000V, V _{GK} =-2V, T _j =125deg (Expo. wave)	3000	—	—	V/μs
t _{gt}	Turn-on time	I _T =800A, V _D =3000V, di/dt=1000A/μs	—	—	5	μs
t _d	Turn-on delay time	C _s =0.1μF, R _s =10ohm, T _j =125deg With GU-D08 (See Fig.1,2)	—	—	1	μs
E _{on}	Turn-on switching energy	I _T =400A, V _D =3000V, di/dt=1000A/μs C _s =0.1μF, R _s =10ohm, T _j =125deg With GU-D08 (See Fig.1,2)	—	—	0.6	J/P
t _s	Storage time	I _T =800A, V _{DM} =3/4V _{DRM} , V _D =3000V C _s =0.1μF, R _s =10ohm, T _j =125deg With GU-D08 (See Fig.1,5)	—	—	3	μs
E _{off}	Turn-off switching energy	I _T =400A, V _{DM} =4000V, V _D =3000V C _s =0.1μF, R _s =10ohm, T _j =125deg With GU-D08 (See Fig.1,5)	—	—	2.3	J/P
Q _{RR}	Reverse recovery charge	I _T =400A, V _R =3000V, di/dt=1000A/μs	—	—	1800	μC
E _{rec}	Reverse recovery energy	C _s =0.1μF, R _s =10ohm, T _j =125deg (See Fig.4,5)	—	—	4.4	J/P
I _{GT}	Gate trigger current	V _D =24V, R _t =0.1ohm, T _j =25deg	—	—	0.5	A
V _{GT}	Gate trigger voltage	DC method	—	—	1.5	V
R _{th(j-f)}	Thermal resistance	Junction to Fin	—	—	0.025	K/W



MITSUBISHI GCT(Gate Commutated Turn-off) THYRISTOR UNIT

GCU08BA-130

HIGH POWER INVERTER USE
PRESS PACK TYPE

GATE DRIVER PART(Type name: GU-D08)

Parameter	Symbol	Unit	Ratings			Conditions
			Min	Typ	Max	
Power supply (NOTE 1)	Vc	V	19	20	21	DC power supply
Power consumption (NOTE 2)	P	W	2.5	-	-	-
Control signal (NOTE 3)	-	-	-	-	-	I _T =420Arms, f=780Hz duty=0.33
Frequency	f	Hz	-	-	780	Optical fiber data link Transmitter: HFBR-1521(HP) Receiver: HFBR-2521(HP) I _T =420A, duty=0.33
Delay time of on gate current	tfd	μs	-	-	3.0	
Delay time of off gate current	trd	μs	-	-	3.0	
Critical rate of rise of on gate current	di _G /dt	A/μs	50	-	-	
Peak on gate current	I _{GM}	A	-	90	-	
Width of on high gate current	tw	μs	3	-	-	
On gate current	I _G	A	1.25	-	-	T _j ≥-10deg
Critical rate of rise of off gate current	di _{CO} /dt	A/μs	-	1200	-	V _{RG} =20V
Maximum duty	Dmax	%	-	-	100	
Temperature	Ta	deg.	-10	-	+60	Operation temperature (Recommend:≤40deg)
Weight	-	g	-	1100	-	With FGC800B-130DS
Status signal (NOTE 4)	-	-	-	-	-	



MITSUBISHI GCT(Gate Commutated Turn-off) THYRISTOR UNIT

GCU08BA-130

HIGH POWER INVERTER USE
PRESS PACK TYPE

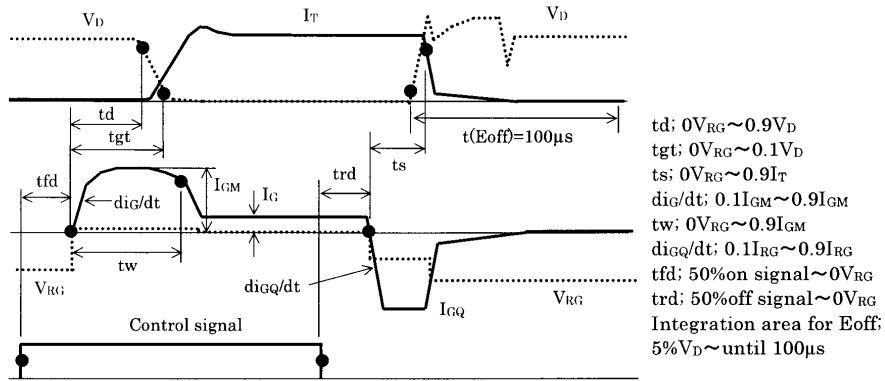

Fig.1: Turn on and turn off waveform

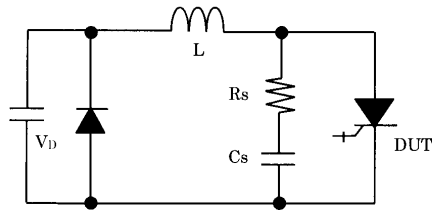

Fig.2: Turn-on test circuit

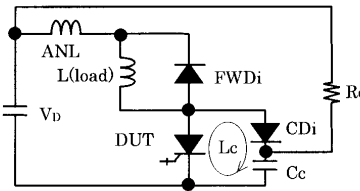

Fig.3: Turn-off test circuit (With clamp circuit)

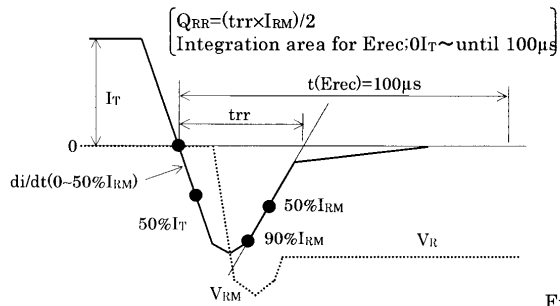

Fig.4: Reverse recovery waveform

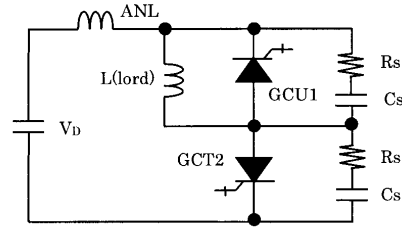

Fig.5: Turn off and Reverse recovery test circuit

[Without the GDU and $I_G = 0.5A$ (DC) is supplied to GCT 1 at reverse recovery test.]

MITSUBISHI GCT(Gate Commutated Turn-off) THYRISTOR UNIT

GCU08BA-130

HIGH POWER INVERTER USE
PRESS PACK TYPE

(NOTE 1): (1)Guaranteed power supply voltage for operation is 19V minimum and 21V maximum.
 (2)When over voltage occurs, GDU voltage bus (G-K voltage for GCT) is clamped to be 21V if maximum voltage for input gate voltage from power supply is 25V and maximum duration of over voltage higher than 21V from power supply is 0.4 sec when control signal is on(Please see Fig.8).
 (3)When over voltage occurs, GDU voltage bus is clamped to be 21V with no time limitation if maximum voltage from power supply is 25V and control signal is off(Please see Fig.8).

(NOTE 2): GCT is off state and no gate signal is supplied for gate driver. No leakage current flows between gate and cathode of GCT.

(NOTE 3): Optic fiber data link HFBR-1521 and HFBR-2521 are interlocked each other.

(NOTE 4): 1. Status signal from LED

(1)Status signal

Status of GCT	LED 1 (Red)	LED 2 (Yellow)
On state	OFF	ON
Off state	ON	OFF

(2)Fault signal

Status	G-K	PS	PS LED (LED 4)	G-K LED (LED 3)
Normal	Normal	20±1V	On	On
Fault	Normal	Voltage down	Off, V<17.5V(Typ.)	Off(If V>12.5V(Typ.) then LED 3 is on)
Fault	G-K short	20±1V	On	Off
Fault	G-K short	Voltage down	Off, V<17.5V(Typ.)	Off

2. Status signal from Transmitter(NOTE 5)

(L: Light NL: No light)

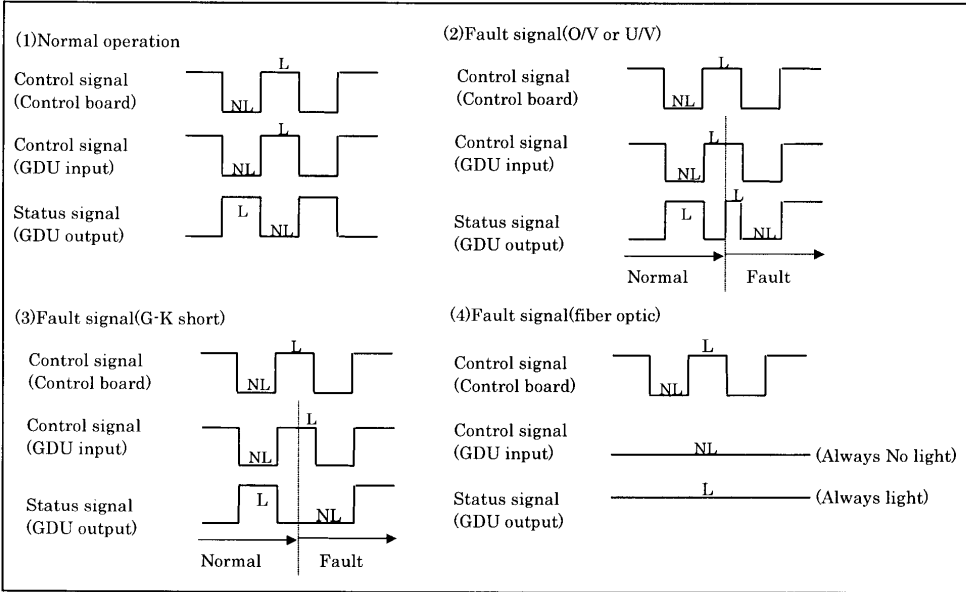

(NOTE 5):About over voltage fault signal, please see Fig.6.

MITSUBISHI GCT(Gate Commutated Turn-off) THYRISTOR UNIT
GCU08BA-130
 HIGH POWER INVERTER USE
 PRESS PACK TYPE

Fig. 6: Over voltage fault signal timing chart

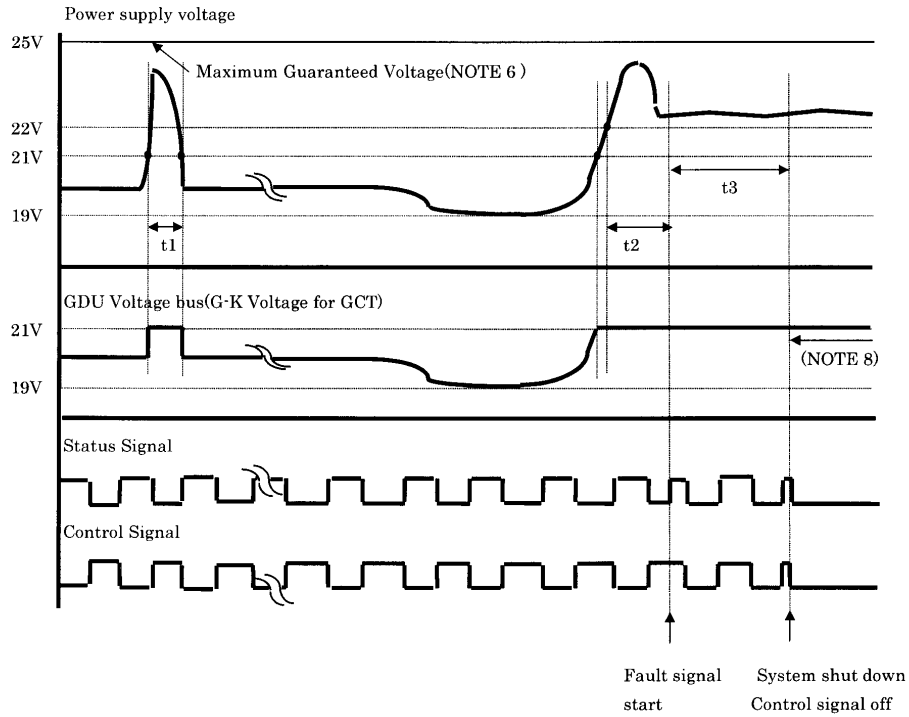

- 1) $t_1 < 1.0 \text{ ms}$
Max. repetition rate: 1 pulse/100 ms
- 2) $t_2 \geq 1.0 \text{ ms}$
- 3) $t_3 < 0.4 \text{ sec}$

(NOTE 6): Maximum peak voltage of GDU input voltage from power supply should be lower than 25V.

(NOTE 7): If the period for over voltage $< 1.0 \text{ ms}$ (period t_1),no fault signal is sent.

If the period for over voltage $\geq 1.0 \text{ ms}$, fault signal starts after period t_2 from 22V of power supply voltage.

System should be shut down(Control signal should be off) within period t_3 from fault signal start.

(NOTE 8):GDU Voltage bus(G-K Voltage for GCT) is clamped to be 21V if power supply voltage is higher than 21V after system shut down(control signal off).

MITSUBISHI GCT(Gate Commutated Turn-off) THYRISTOR UNIT

GCU08BA-130

HIGH POWER INVERTER USE
PRESS PACK TYPE

Dimensions in mm

OUTLINE DRAWING

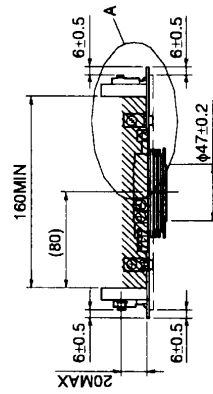
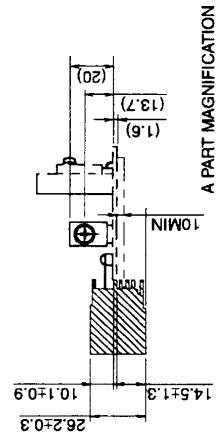
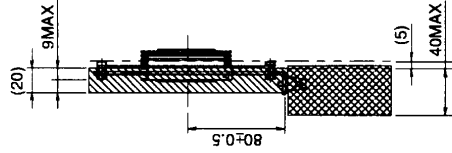
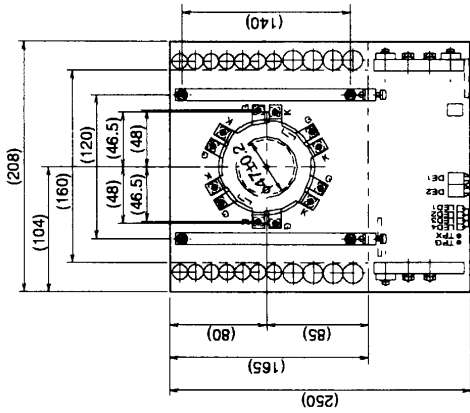

MITSUBISHI GCT(Gate Commutated Turn-off) THYRISTOR UNIT

GCU08BA-130

HIGH POWER INVERTER USE
PRESS PACK TYPE

MAXIMUM ON STATE CHARACTERISTIC

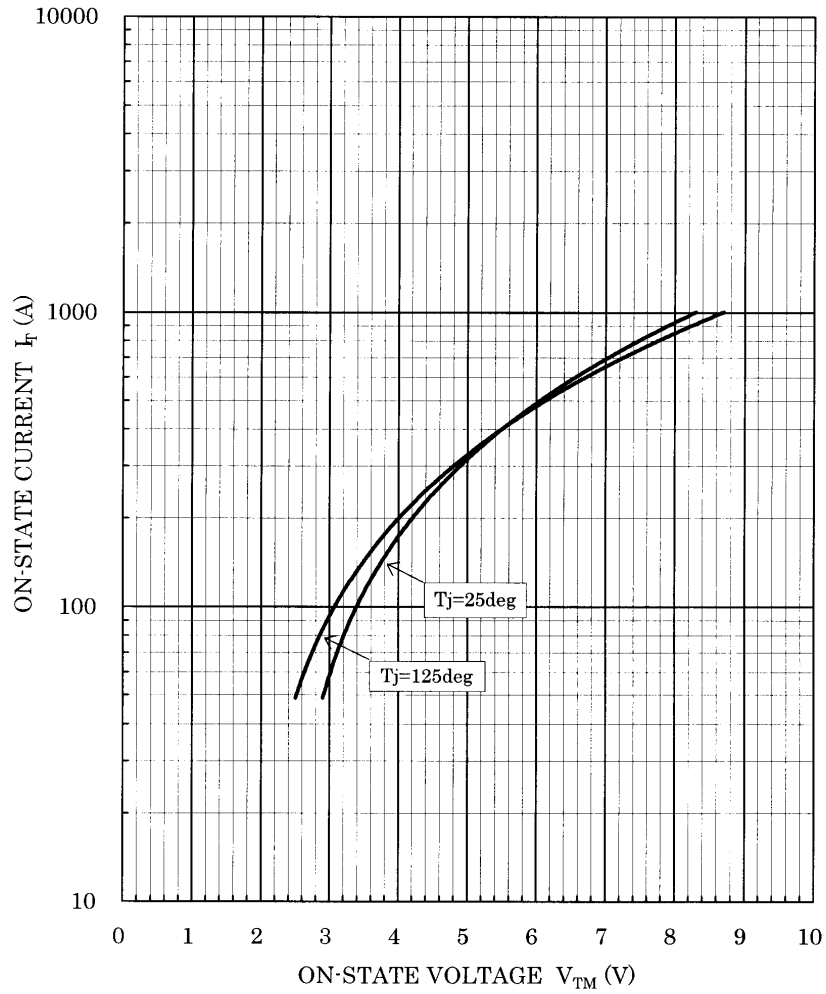

MITSUBISHI GCT(Gate Commutated Turn-off) THYRISTOR UNIT

GCU08BA-130

HIGH POWER INVERTER USE
PRESS PACK TYPE

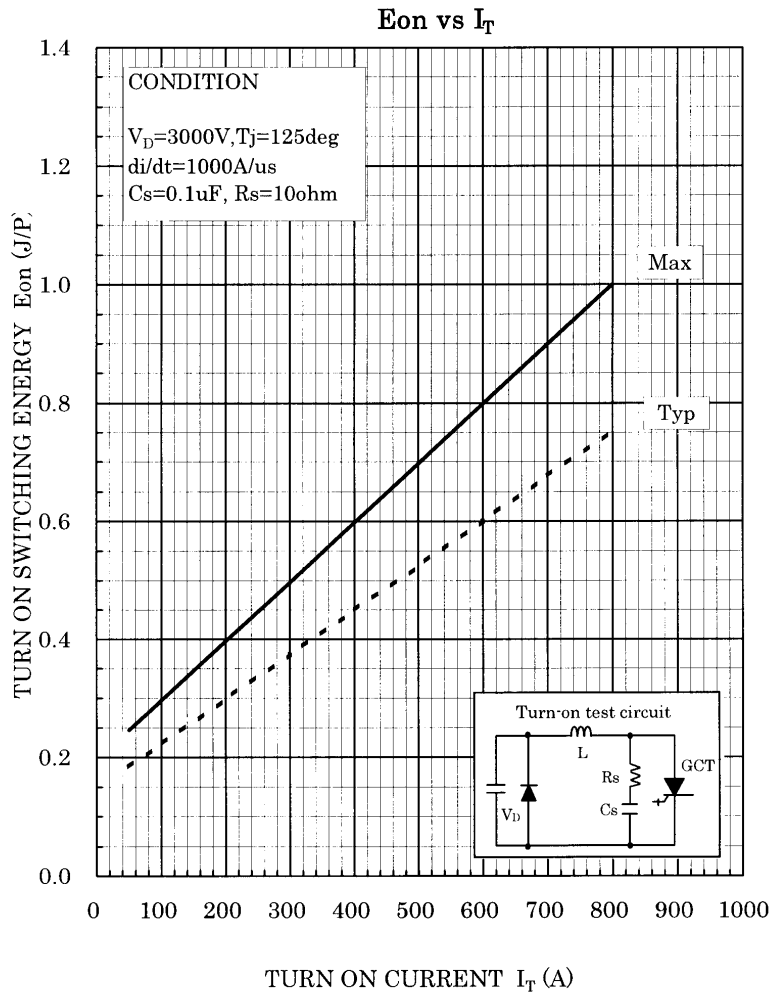

MITSUBISHI GCT(Gate Commutated Turn-off) THYRISTOR UNIT

GCU08BA-130

HIGH POWER INVERTER USE
PRESS PACK TYPE

E_{off} vs I_T

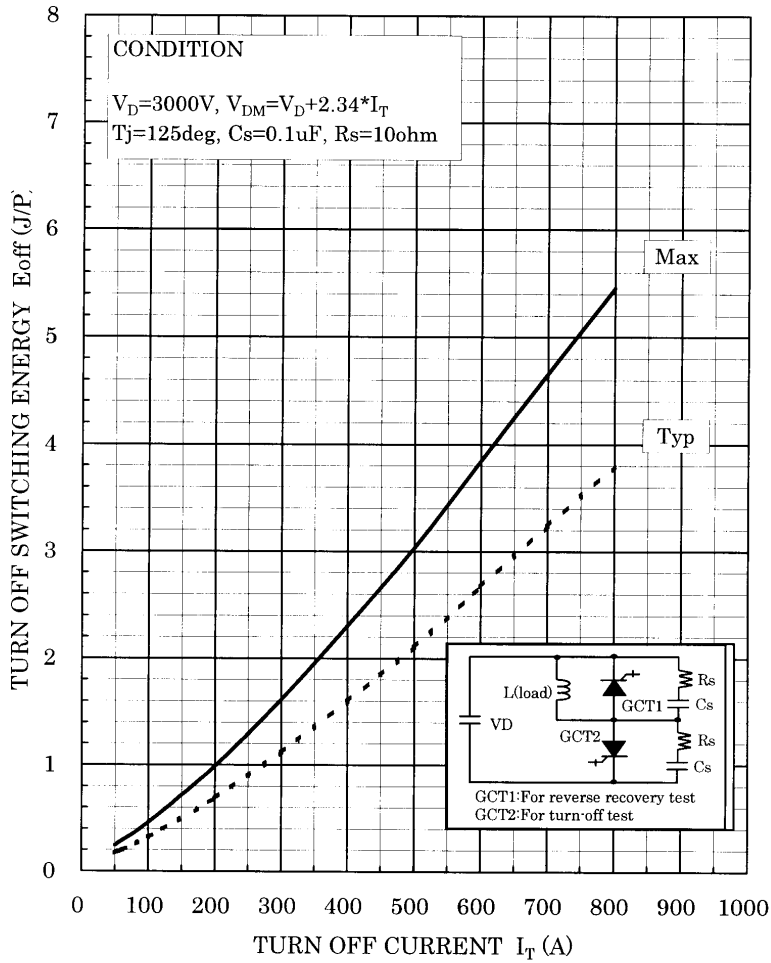

mitsubishi GCT(Gate Commutated Turn-off) THYRISTOR UNIT
GCU08BA-130
 HIGH POWER INVERTER USE
 PRESS PACK TYPE

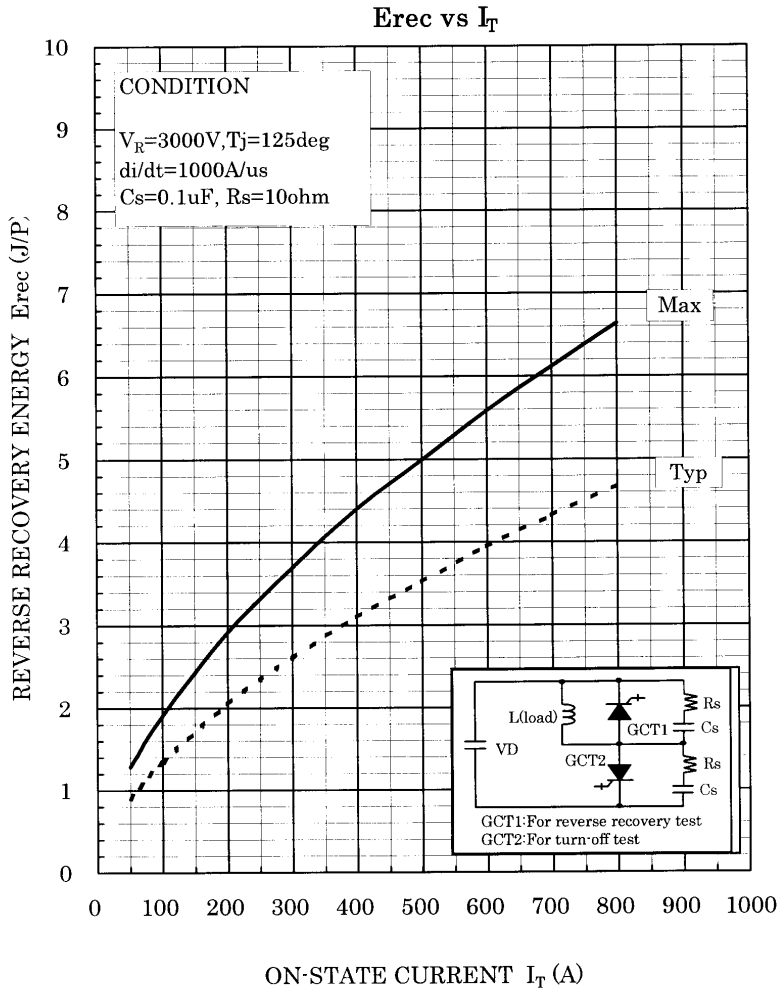

MITSUBISHI GCT(Gate Commutated Turn-off) THYRISTOR UNIT

GCU08BA-130

HIGH POWER INVERTER USE
PRESS PACK TYPE

