

General purpose transistor (isolated transistors)

EMD29

DTB513Z □ and DTC114E □ A are housed independently in a EMT6 package.

●Applications

DC / DC converter
Motor driver

●Features

- 1) DT_{r1} : PNP digital transistor
DT_{r2} : NPN digital transistor
- 2) Mounting possible with EMT3 automatic mounting machines.

●Structure

PNP / NPN Silicon epitaxial planar digital transistor

The following characteristics apply to both DT_{r1} and DT_{r2}.

●Equivalent circuit

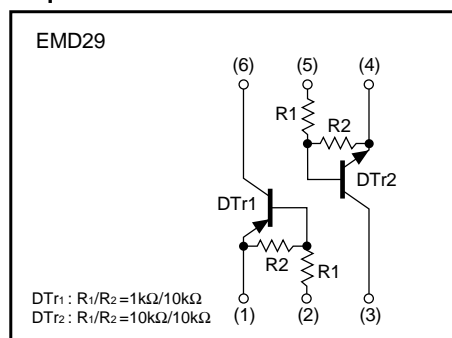

●Packaging specifications

Type	EMD29
Package	EMT6
Marking	D29
Code	T2R
Basic ordering unit (pieces)	8000

●External dimensions (Unit : mm)

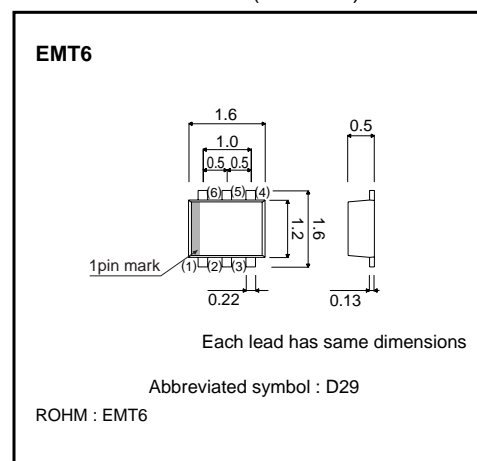

Transistors

●Absolute maximum ratings (Ta=25°C)

DTr1

Parameter	Symbol	DTr1	Unit
Supply voltage	V _{CC}	-12	V
Input voltage	V _{IN}	-12 to +5	V
Output current	I _{C (MAX.)}	-500	mA
Power dissipation	P _d	120	mW *
Junction temperature	T _j	150	°C
Storage temperature	T _{stg}	-55 to +150	°C

* Each terminal mounted on a recommended.

DTr2

Parameter	Symbol	DTr2	Unit
Supply voltage	V _{CC}	50	V
Input voltage	V _{IN}	-10 to +40	V
Output current	I _o	50	mA
	I _{C (MAX.)}	100	
Power dissipation	P _d	120	mW *
Junction temperature	T _j	150	°C
Storage temperature	T _{stg}	-55 to +150	°C

* Each terminal mounted on a recommended.

DTr1/DTr2

Parameter	Symbol	Limits	Unit
Power dissipation	P _d	150(TOTAL)	mW *
Storage temperature	T _{stg}	-55 to +125	°C

* Each terminal mounted on a recommended.

Transistors

●Electrical characteristics (Ta=25°C)

DTr1

Parameter	Symbol	Min.	Typ.	Max.	Unit	Conditions
Input voltage	$V_{I(off)}$	–	–	–0.3	V	$V_{CC} = -5V / I_o = -100\mu A$
	$V_{I(on)}$	–2.5	–	–	V	$V_o = -0.3V / I_o = -20mA$
Output voltage	$V_{O(on)}$	–	–60	–300	mV	$I_o = -100mA, I_i = -5mA$
Input current	I_i	–	–	–6.4	mA	$V_i = -5V$
Output current	$I_{O(off)}$	–	–	–0.5	μA	$V_{CC} = -12V / V_i = 0V$
DC current gain	G_i	140	–	–	–	$V_o = -2V / I_o = -100mA$
Transition frequency	f_T	–	260	–	MHz	$V_{CE} = -10V / I_E = 5mA, f = 100MHz$
Input resistance	R_1	0.7	1.0	1.3	$k\Omega$	–
Resistance ratio	R_2/R_1	8	10	12	–	–

* Characteristics of built-in transistor.

DTr2

Parameter	Symbol	Min.	Typ.	Max.	Unit	Conditions
Input voltage	$V_{I(off)}$	–	–	0.5	V	$V_{CC} = 5V / I_o = 100\mu A$
	$V_{I(on)}$	3	–	–	V	$V_o = 0.3V / I_o = 2mA$
Output voltage	$V_{O(on)}$	–	100	300	mV	$I_o = 10mA, I_i = 0.5mA$
Input current	I_i	–	–	880	μA	$V_i = 5V$
Output current	$I_{O(off)}$	–	–	0.5	μA	$V_{CC} = 50V / V_i = 0V$
DC current gain	G_i	30	–	–	–	$V_o = 5V / I_o = 5mA$
Transition frequency	f_T	–	250	–	MHz	$V_{CE} = 10V / I_E = -5mA, f = 100MHz$
Input resistance	R_1	7	10	13	$k\Omega$	–
Resistance ratio	R_2/R_1	0.8	1	1.2	–	–

* Characteristics of built-in transistor.

Transistors

●Electrical characteristic curves

DTr1

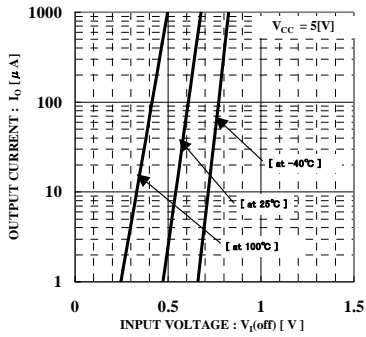

Fig.1 Output current vs. input voltage (OFF characteristics)

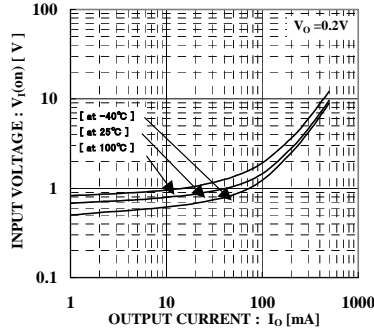

Fig.2 Input voltage vs. output current (ON characteristics) I

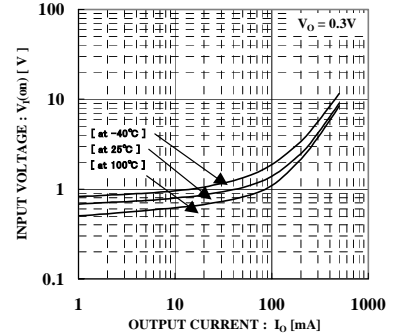

Fig.3 Input voltage vs. output current (ON characteristics) II

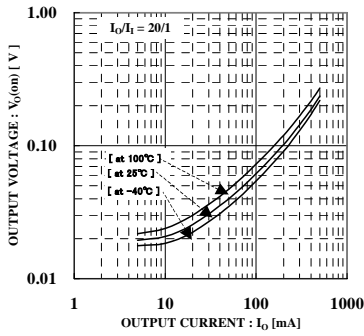

Fig.4 Output voltage vs. output current I

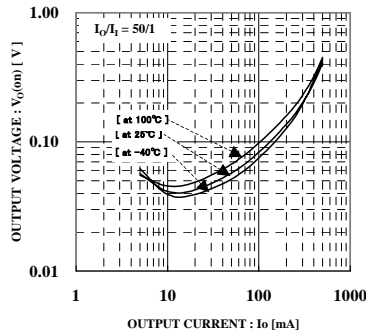

Fig.5 Output voltage vs. output current II

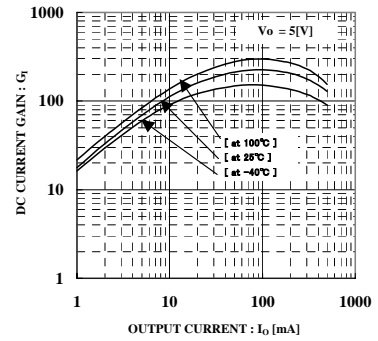

Fig.6 DC current gain vs. output current

Transistors

DTr2

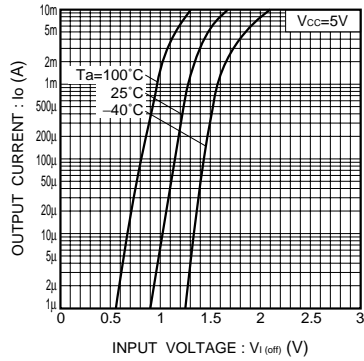

Fig.7 Output current vs. input voltage (OFF characteristics)

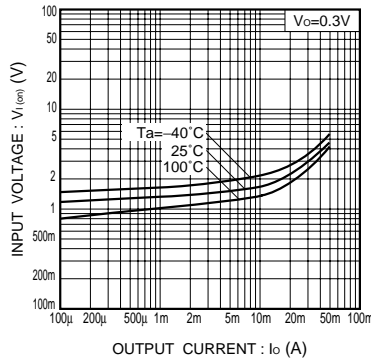

Fig.8 Input voltage vs. output current (ON characteristics)

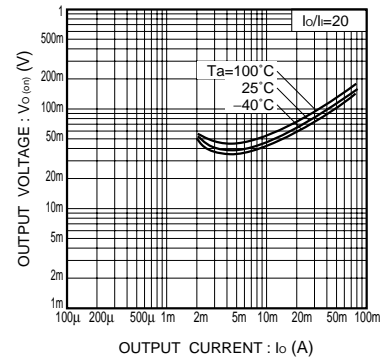

Fig.9 Output voltage vs. output current

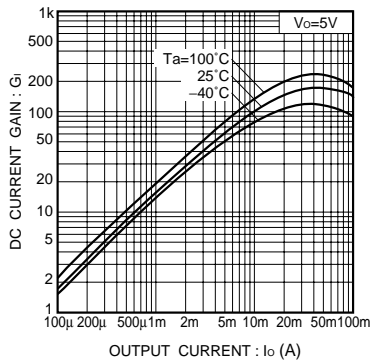

Fig.10 DC current gain vs. output current

Notes

- No technical content pages of this document may be reproduced in any form or transmitted by any means without prior permission of ROHM CO.,LTD.
- The contents described herein are subject to change without notice. The specifications for the product described in this document are for reference only. Upon actual use, therefore, please request that specifications to be separately delivered.
- Application circuit diagrams and circuit constants contained herein are shown as examples of standard use and operation. Please pay careful attention to the peripheral conditions when designing circuits and deciding upon circuit constants in the set.
- Any data, including, but not limited to application circuit diagrams information, described herein are intended only as illustrations of such devices and not as the specifications for such devices. ROHM CO.,LTD. disclaims any warranty that any use of such devices shall be free from infringement of any third party's intellectual property rights or other proprietary rights, and further, assumes no liability of whatsoever nature in the event of any such infringement, or arising from or connected with or related to the use of such devices.
- Upon the sale of any such devices, other than for buyer's right to use such devices itself, resell or otherwise dispose of the same, no express or implied right or license to practice or commercially exploit any intellectual property rights or other proprietary rights owned or controlled by
- ROHM CO., LTD. is granted to any such buyer.
- Products listed in this document are no antiradiation design.

The products listed in this document are designed to be used with ordinary electronic equipment or devices (such as audio visual equipment, office-automation equipment, communications devices, electrical appliances and electronic toys).

Should you intend to use these products with equipment or devices which require an extremely high level of reliability and the malfunction of which would directly endanger human life (such as medical instruments, transportation equipment, aerospace machinery, nuclear-reactor controllers, fuel controllers and other safety devices), please be sure to consult with our sales representative in advance.

About Export Control Order in Japan

Products described herein are the objects of controlled goods in Annex 1 (Item 16) of Export Trade Control Order in Japan.

In case of export from Japan, please confirm if it applies to "objective" criteria or an "informed" (by MITI clause) on the basis of "catch all controls for Non-Proliferation of Weapons of Mass Destruction.