

NPN SILICON PLANAR EPITAXIAL TRANSISTOR

CMBTH10

**SOT-23
Formed SMD Package**

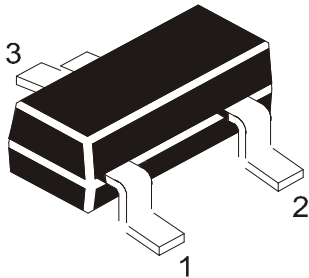

PIN CONFIGURATION (NPN)

- 1 = BASE
- 2 = EMITTER
- 3 = COLLECTOR

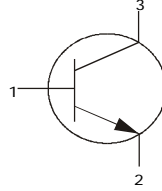

Marking Code = 3E

VHF/UHF Transistor

ABSOLUTE MAXIMUM RATINGS

DESCRIPTION	SYMBOL	VALUE	UNITS
Collector Emitter Voltage	V_{CEO}	25	V
Collector Base Voltage	V_{CBO}	30	V
Emitter Base Voltage	V_{EBO}	3.0	V

THERMAL CHARACTERISTICS

*Device Dissipation FR-5 Board, $T_a=25^\circ\text{C}$ Derate above $=25^\circ\text{C}$	P_D	225 1.8	mW mW/ $^\circ\text{C}$
Thermal Resistance Junction to Ambient in free Air	$R_{th(j-a)}$	556	$^\circ\text{C}/\text{mW}$
**Device Dissipation Alumina Substrate, $T_a=25^\circ\text{C}$ Derate above $=25^\circ\text{C}$	P_D	300 2.4	mW mW/ $^\circ\text{C}$
Thermal Resistance Junction to Ambient in free Air	$R_{th(j-a)}$	417	$^\circ\text{C}/\text{mW}$
Junction and Storage Temperature	T_j, T_{stg}	150	$^\circ\text{C}$

* FR-5 Board=25.4 x 19.05 x 1.58 mm (1.0 x 0.75 x 0.062 inches)

** Alumina Substrate=10.16 x 7.62 x 0.61 mm (0.4 x 0.3 x 0.024 inches) 99.5% alumina.

Electrical Characteristics ($T_a=25^\circ\text{C}$ unless specified otherwise)

DESCRIPTION	SYMBOL	CONDITIONS	MIN	MAX	UNIT
Collector Emitter Voltage	V_{CEO}	$I_C=1\text{mA}, I_B=0$	25		V
Collector Base Voltage	V_{CBO}	$I_C=100\mu\text{A}, I_E=0$	30		V
Emitter Base Voltage	V_{EBO}	$I_E=10\mu\text{A}, I_C=0$	3		V
Collector Cut Off Current	I_{CBO}	$V_{CB}=25\text{V}, I_E=0$		100	nA
Emitter Cut Off Current	I_{EBO}	$V_{EB}=2\text{V}, I_C=0$		100	nA
DC Current Gain	h_{FE}	$V_{CE}=10\text{V}, I_C=4\text{mA}$	60		
Collector Emitter Saturation Voltage	$V_{CE(sat)}$	$I_C=4\text{mA}, I_B=0.4\text{mA}$		0.50	V
Base Emitter On Voltage	$V_{BE(on)}$	$V_{CE}=10\text{V}, I_C=4\text{mA}$		0.95	V

NPN SILICON PLANAR EPITAXIAL TRANSISTOR

CMBTH10

SOT-23
Formed SMD Package

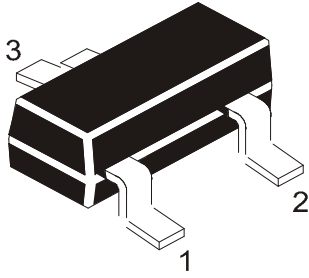

PIN CONFIGURATION (NPN)

1 = BASE
2 = EMITTER
3 = COLLECTOR

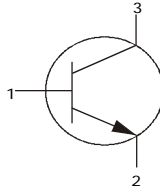

Electrical Characteristics ($T_a=25^\circ\text{C}$ unless specified otherwise)

DYNAMIC CHARACTERISTICS

DESCRIPTION	SYMBOL	CONDITIONS	MIN	MAX	UNIT
Current Gain - Bandwidth Product	f_T	$V_{CE}=10\text{V}$, $I_C=4\text{mA}$, $f=100\text{MHz}$	650		MHz
Collector Base Capacitance	C_{cb}	$V_{CB}=10\text{V}$, $I_E=0$, $f=1\text{MHz}$		0.70	pF
Common Base Feedback Capacitance	C_{rb}	$V_{CB}=10\text{V}$, $I_E=0$, $f=1\text{MHz}$		0.65	pF
Collector Base Time Constant	$r_b' C_c$	$V_{CB}=10\text{V}$, $I_C=4\text{mA}$, $f=31.8\text{MHz}$		9.0	ps

SOT-23 Formed SMD Package

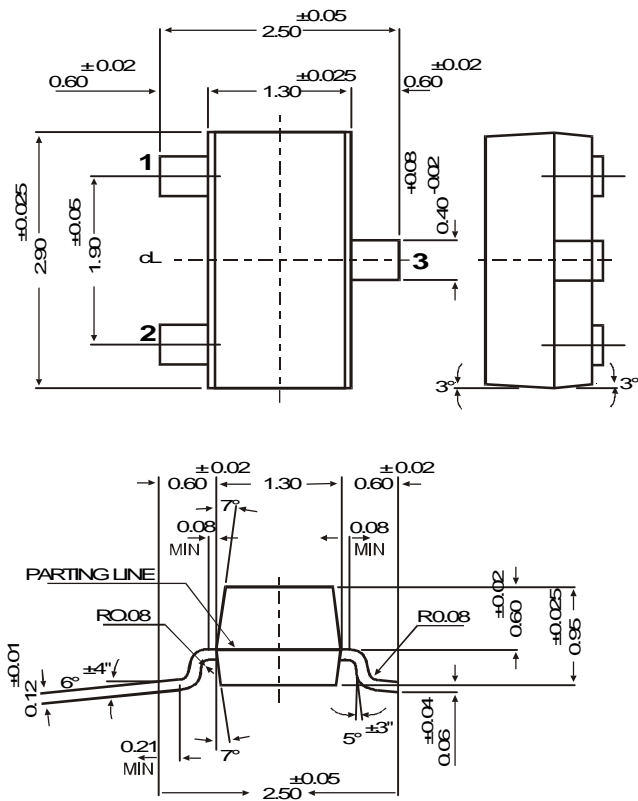

SOT-23 Package Reel Information
Reel Specifications for W Packing (13" and 7")

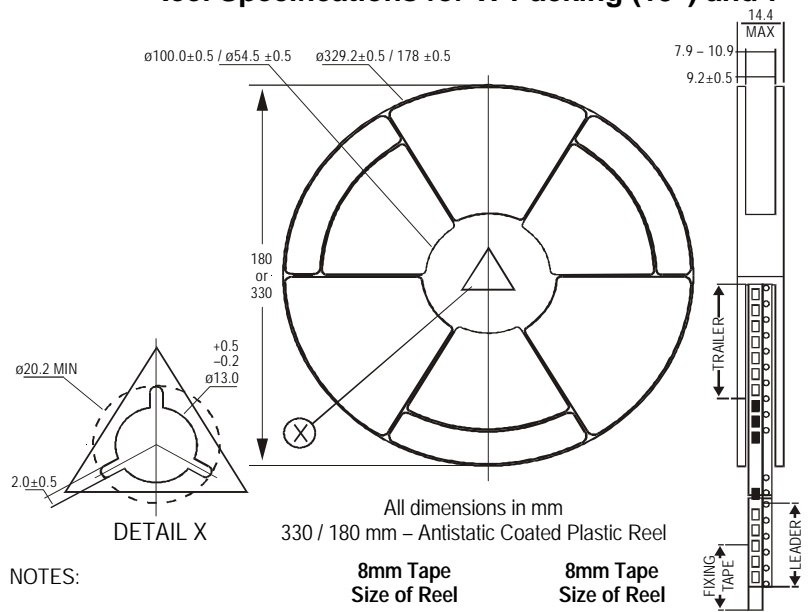

All dimensions in mm
330 / 180 mm – Antistatic Coated Plastic Reel

NOTES:

- | | 8mm Tape Size of Reel | 8mm Tape Size of Reel |
|----------------|-----------------------|-----------------------|
| No. of Devices | 10,000 Pcs | 3,000 Pcs |
- The bandolier of 330 mm reel contains at least 10,000 devices.
 - The bandolier of 180 mm reel contains at least 3,000 devices.
 - No more than 0.5% missing devices / reel. 50 empty compartments for 330 mm reel. 15 empty compartments for 180 mm reel.
 - Three consecutive empty places might be found provided this gap is followed by 6 consecutive devices.
 - The carrier tape (leader) starts with at least 75 empty positions (equivalent to 330 mm). In order to fix the carrier tape a self adhesive tape of 20 to 50 mm is applied. At the end of the bandolier at least 40 empty positions (equivalent to 160 mm) are there.

Tape Specification for SOT-23 Surface Mount Device

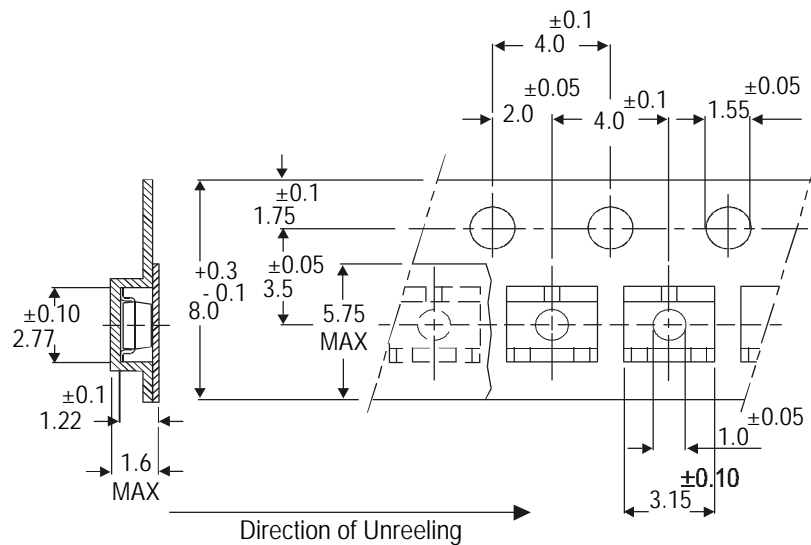

All dimensions in mm

Packing Detail

PACKAGE	STANDARD PACK		INNER CARTON BOX		OUTER CARTON BOX		
	Details	Net Weight/Qty	Size	Qty	Size	Qty	Gr Wt
SOT-23 T&R	3K/reel	136 gm/3K pcs	3" x 7.5" x 7.5"	12 K	17" x 15" x 13.5"	192 K	12 kgs
	10K/reel	415 gm/10K pcs	9" x 9" x 9"	51 K	19" x 19" x 19"	408 K	28 kgs
			13" x 13" x 0.5"	10 K	17" x 15" x 13.5"	300 K	16 kgs

Disclaimer

The product information and the selection guides facilitate selection of the CDIL's Discrete Semiconductor Device(s) best suited for application in your product(s) as per your requirement. It is recommended that you completely review our Data Sheet(s) so as to confirm that the Device(s) meet functionality parameters for your application. The information furnished in the Data Sheet and on the CDIL Web Site/CD are believed to be accurate and reliable. CDIL however, does not assume responsibility for inaccuracies or incomplete information. Furthermore, CDIL does not assume liability whatsoever, arising out of the application or use of any CDIL product; neither does it convey any license under its patent rights nor rights of others. These products are not designed for use in life saving/support appliances or systems. CDIL customers selling these products (either as individual Discrete Semiconductor Devices or incorporated in their end products), in any life saving/support appliances or systems or applications do so at their own risk and CDIL will not be responsible for any damages resulting from such sale(s).

CDIL strives for continuous improvement and reserves the right to change the specifications of its products without prior notice.



CDIL is a registered Trademark of
Continental Device India Limited

C-120 Naraina Industrial Area, New Delhi 110 028, India.
Telephone + 91-11-2579 6150, 5141 1112 Fax + 91-11-2579 5290, 5141 1119
email@cdil.com www.cdilsemi.com