

CED9926/CEU9926

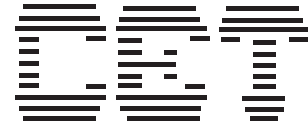

PRELIMINARY

N-Channel Logic Level Enhancement Mode Field Effect Transistor

6

FEATURES

- 20V , 26A , $R_{DS(ON)}=30m\Omega$ @ $V_{GS}=4.5V$.
 $R_{DS(ON)}=40m\Omega$ @ $V_{GS}=2.5V$.
- Super high dense cell design for extremely low $R_{DS(ON)}$.
- High power and current handling capability.
- TO-251 & TO-252 package.

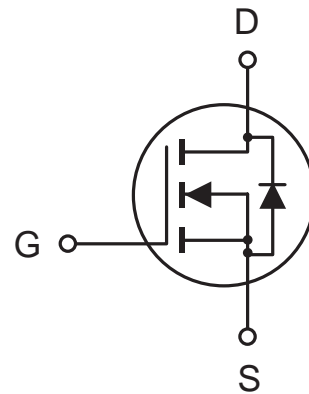

ABSOLUTE MAXIMUM RATINGS ($T_c=25^\circ C$ unless otherwise noted)

Parameter	Symbol	Limit	Unit
Drain-Source Voltage	V_{DS}	20	V
Gate-Source Voltage	V_{GS}	± 12	V
Drain Current-Continuous -Pulsed	I_D	26	A
	I_{DM}	78	A
Drain-Source Diode Forward Current	I_S	26	A
Maximum Power Dissipation @ $T_c=25^\circ C$ Derate above $25^\circ C$	P_D	38	W
		0.25	W/ $^\circ C$
Operating and Storage Temperature Range	T_J, T_{STG}	-55 to 175	$^\circ C$

THERMAL CHARACTERISTICS

Thermal Resistance, Junction-to-Case	$R_{\theta JC}$	4	$^\circ C/W$
Thermal Resistance, Junction-to-Ambient	$R_{\theta JA}$	50	$^\circ C/W$

CED9926/CEU9926

ELECTRICAL CHARACTERISTICS (Tc=25°C unless otherwise noted)

Parameter	Symbol	Condition	Min	Typ ^c	Max	Unit
OFF CHARACTERISTICS						
Drain-Source Breakdown Voltage	BV _{DSS}	V _{GS} = 0V, I _D = 250μA	20			V
Zero Gate Voltage Drain Current	I _{DSS}	V _{DS} = 20V, V _{GS} = 0V			1	μA
Gate-Body Leakage	I _{GSS}	V _{GS} = ±12V, V _{DS} = 0V			±100	nA
ON CHARACTERISTICS^a						
Gate Threshold Voltage	V _{GS(th)}	V _{DS} = V _{GS} , I _D = 250μA	0.5		1.5	V
Drain-Source On-State Resistance	R _{DS(on)}	V _{GS} = 4.5V, I _D = 8A			30	mΩ
		V _{GS} = 2.5V, I _D = 6.6A			40	mΩ
On-State Drain Current	I _{D(on)}	V _{DS} = 5V, V _{GS} = 4.5V	26			A
Forward Transconductance	g _{FS}	V _{DS} = 10V, I _D = 8A		15		S
DYNAMIC CHARACTERISTICS^b						
Input Capacitance	C _{ISS}	V _{DS} = 15V, V _{GS} = 0V f = 1.0MHz		500		pF
Output Capacitance	C _{OSS}			300		pF
Reverse Transfer Capacitance	C _{RSS}			140		pF
SWITCHING CHARACTERISTICS^b						
Turn-On Delay Time	t _{D(on)}	V _{DD} = 10V, I _D = 1A V _{GS} = 4.5V, R _{GEN} = 6Ω		20	40	ns
Rise Time	t _r			18	40	ns
Turn-Off Delay Time	t _{D(off)}			60	108	ns
Fall Time	t _f			28	56	ns
Total Gate Charge	Q _g	V _{DS} = 10V, I _D = 8A V _{GS} = 4.5V		10	15	nC
Gate-Source Charge	Q _{gs}			2.3		nC
Gate-Drain Charge	Q _{gd}			2.9		nC

CED9926/CEU9926

ELECTRICAL CHARACTERISTICS ($T_c=25^\circ\text{C}$ unless otherwise noted)

Parameter	Symbol	Condition	Min	Typ	Max	Unit
DRAIN-SOURCE DIODE CHARACTERISTICS ^a						
Diode Forward Voltage	V_{SD}	$V_{GS} = 0V, I_s = 4A$			1.3	V

6

Notes

- a. Pulse Test: Pulse Width $\leq 300 \mu s$, Duty Cycle $\leq 2\%$.
- b. Guaranteed by design, not subject to production testing.

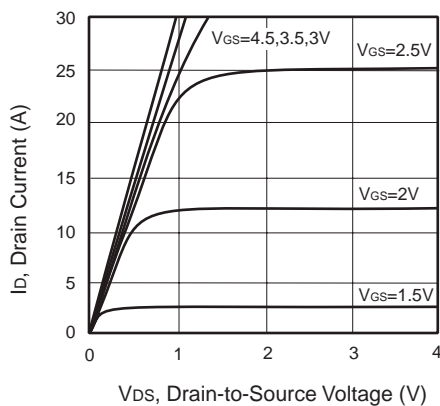

Figure 1. Output Characteristics

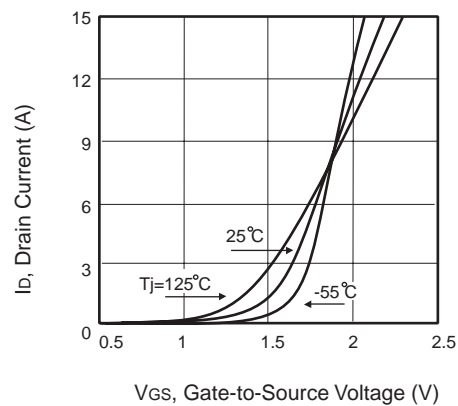

Figure 2. Transfer Characteristics

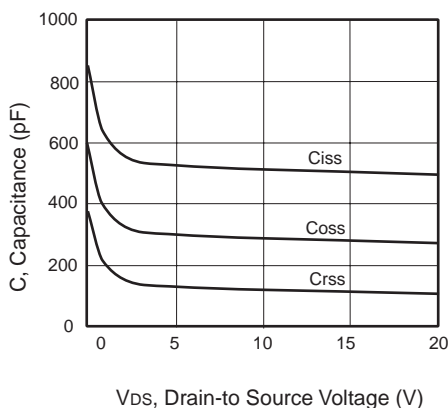

Figure 3. Capacitance

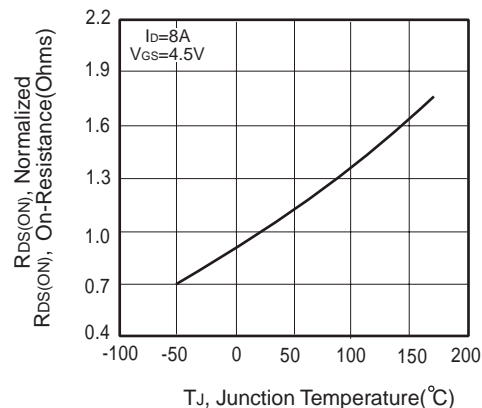

Figure 4. On-Resistance Variation with Temperature

CED9926/CEU9926

6

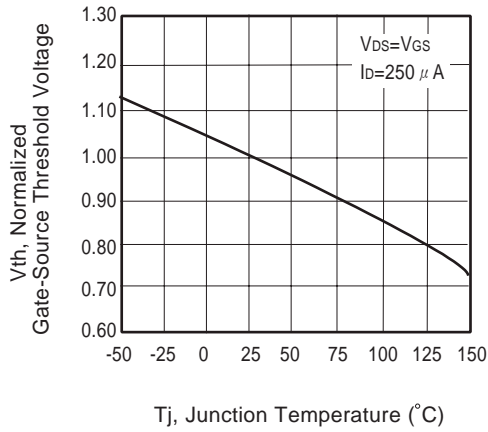

Figure 5. Gate Threshold Variation with Temperature

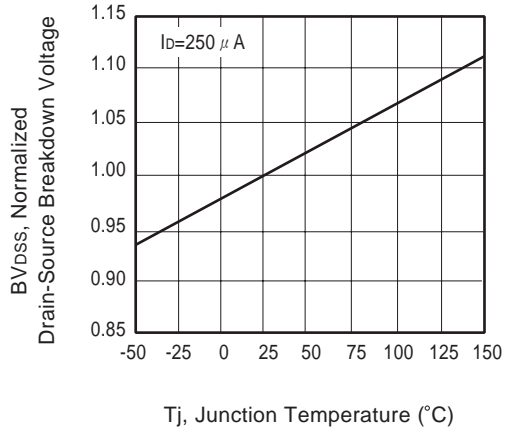

Figure 6. Breakdown Voltage Variation with Temperature

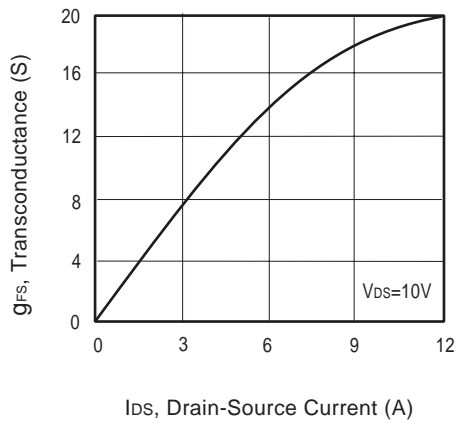

Figure 7. Transconductance Variation with Drain Current

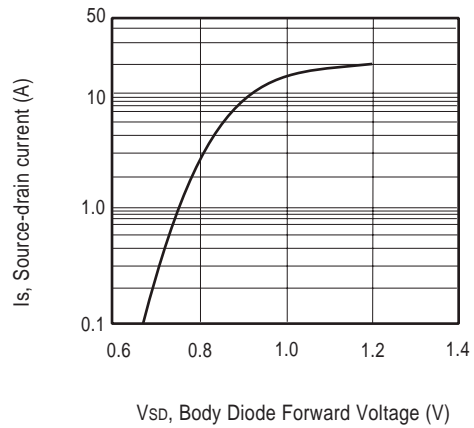

Figure 8. Body Diode Forward Voltage Variation with Source Current

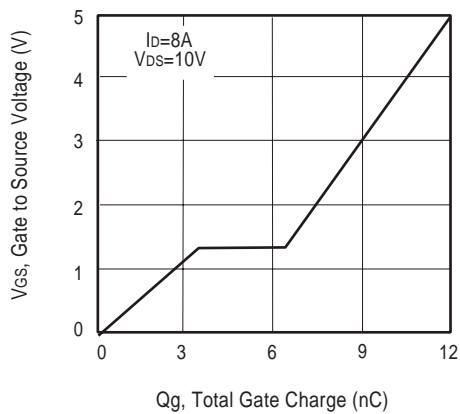

Figure 9. Gate Charge

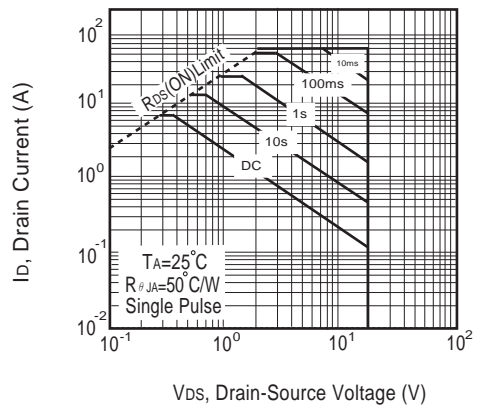

Figure 10. Maximum Safe Operating Area

CED9926/CEU9926

6

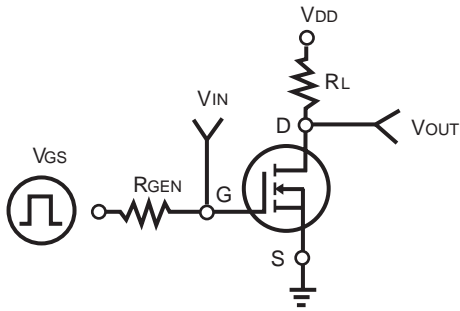

Figure 11. Switching Test Circuit

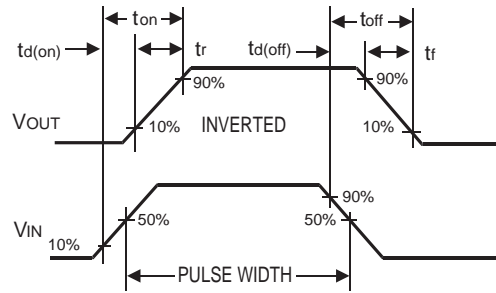

Figure 12. Switching Waveforms

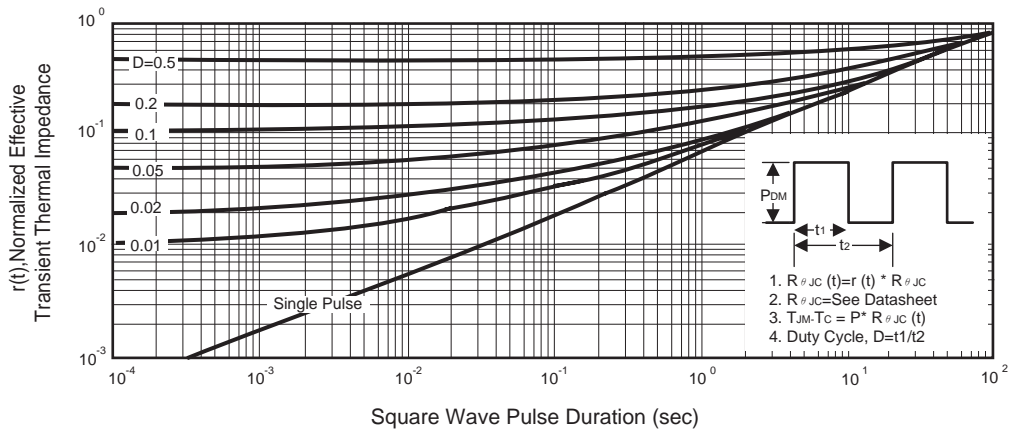

Figure 13. Normalized Thermal Transient Impedance Curve