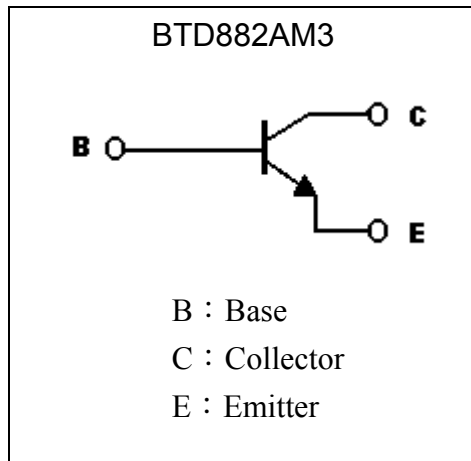
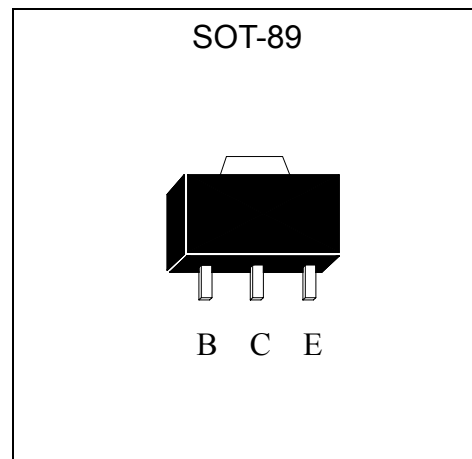

Low $V_{CE(sat)}$ NPN Epitaxial Planar Transistor

BTD882AM3

Features

- Low $V_{CE(sat)}$, typically 0.25V at $I_C / I_B = 2A / 0.2A$
- Excellent current gain characteristics
- Complementary to BTB772AM3

Symbol

Outline

Absolute Maximum Ratings ($T_a=25^\circ\text{C}$)

| Parameter | Symbol | Limit | Unit |
|---|-----------------|---------------|--------------------|
| Collector-Base Voltage | V_{CBO} | 80 | V |
| Collector-Emitter Voltage | V_{CEO} | 50 | V |
| Emitter-Base Voltage | V_{EBO} | 5 | V |
| Collector Current (DC) | I_C | 3 | A |
| Collector Current (Pulse) | I_{CP} | 7 (Note 1) | A |
| Power Dissipation | P_d | 600 | mW |
| | | 1 (Note 2) | W |
| | | 2 (Note 3) | W |
| Thermal Resistance, Junction to Ambient | $R_{\theta JA}$ | 208 | $^\circ\text{C/W}$ |
| | | 125 (Note 2) | $^\circ\text{C/W}$ |
| | | 62.5 (Note 3) | $^\circ\text{C/W}$ |
| Junction Temperature | T_j | 150 | $^\circ\text{C}$ |
| Storage Temperature | T_{stg} | -55~+150 | $^\circ\text{C}$ |

 Note : 1. Single Pulse $P_w \leq 350\mu\text{s}$, Duty $\leq 2\%$.

 2. When mounted on FR-4 PCB with area measuring $10 \times 10 \times 1$ mm

 3. When mounted on ceramic with area measuring $40 \times 40 \times 1$ mm



Characteristics (Ta=25°C)

| Symbol | Min. | Typ. | Max. | Unit | Test Conditions |
|-----------------------|------|------|------|------|---|
| BV _{CBO} | 80 | - | - | V | I _C =50μA, I _E =0 |
| BV _{CEO} | 50 | - | - | V | I _C =1mA, I _B =0 |
| BV _{EBO} | 5 | - | - | V | I _E =50μA, I _C =0 |
| I _{CBO} | - | - | 1 | μA | V _{CB} =50V, I _E =0 |
| I _{EBO} | - | - | 1 | μA | V _{EB} =3V, I _C =0 |
| *V _{CE(sat)} | - | 0.25 | 0.5 | V | I _C =2A, I _B =0.2A |
| *V _{BE(sat)} | - | - | 2 | V | I _C =2A, I _B =0.2A |
| *h _{FE1} | 120 | - | - | - | V _{CE} =2V, I _C =100mA |
| *h _{FE2} | 160 | - | 820 | - | V _{CE} =2V, I _C =500mA |
| *h _{FE3} | 100 | - | - | - | V _{CE} =2V, I _C =1A |
| f _T | - | 90 | - | MHz | V _{CE} =5V, I _C =0.1A, f=100MHz |
| C _{ob} | - | 45 | - | pF | V _{CB} =10V, f=1MHz |

*Pulse Test : Pulse Width ≤380μs, Duty Cycle≤2%

Classification Of hFE2

| Rank | P | E | T |
|-------|---------|---------|---------|
| Range | 160~320 | 270~560 | 390~820 |

Characteristic Curves

Current gain vs Collector current

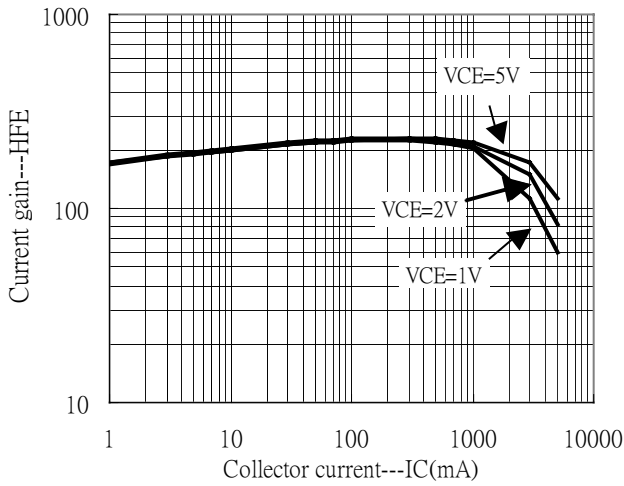

Saturation voltage vs Collector current

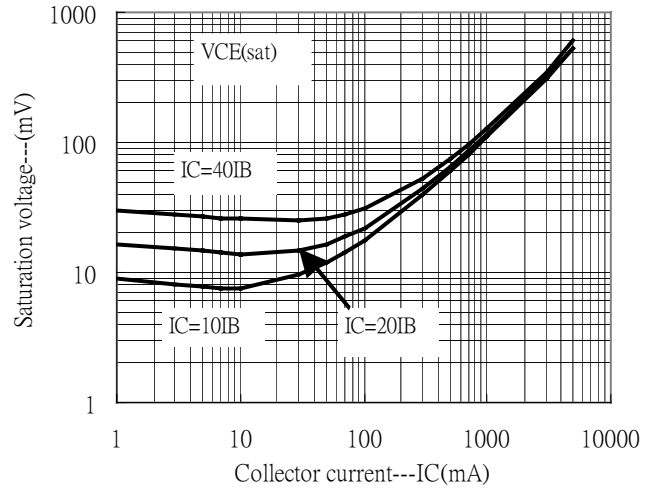

Saturation voltage vs Collector current

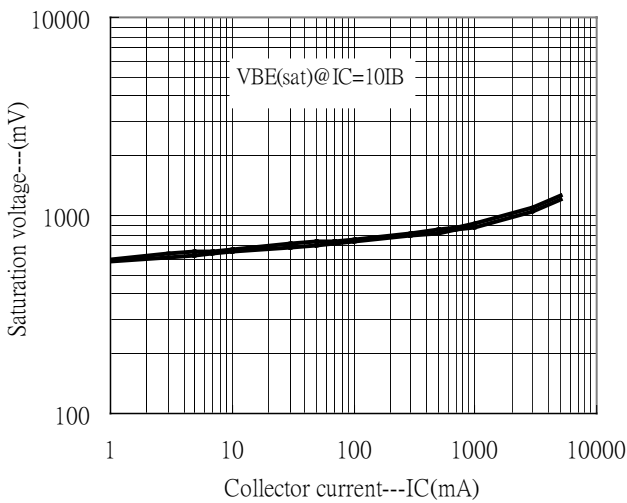

Power Derating Curves

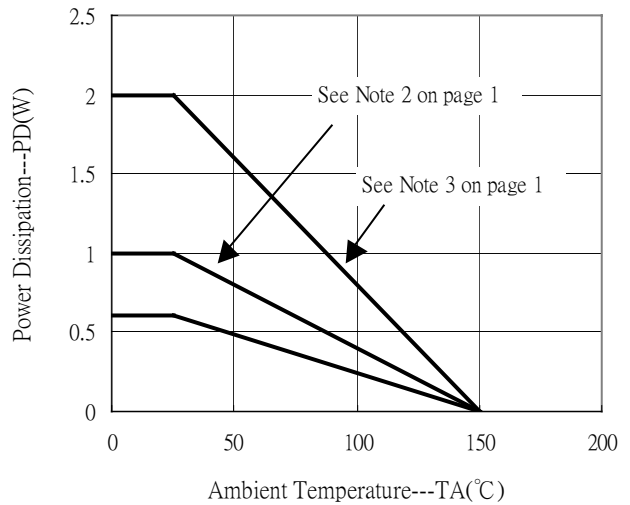

SOT-89 Dimension

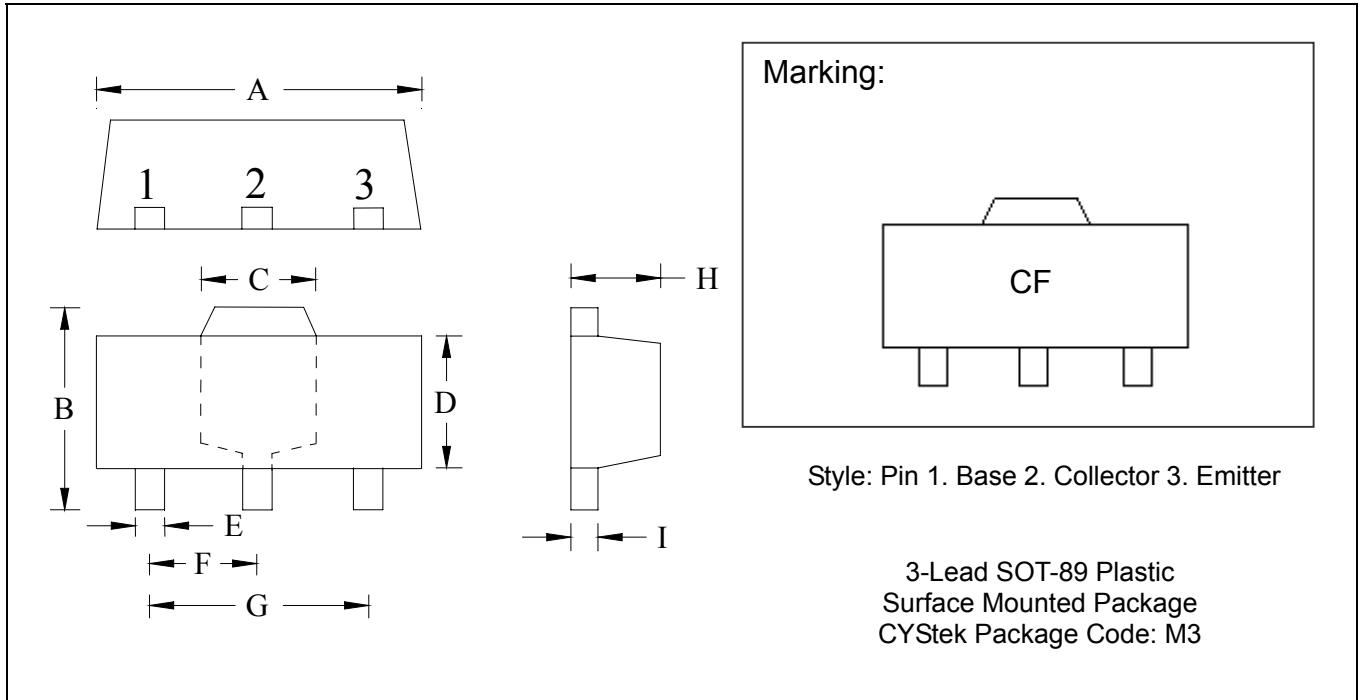

*: Typical

| DIM | Inches | | Millimeters | | DIM | Inches | | Millimeters | |
|-----|---------|--------|-------------|------|-----|--------|--------|-------------|-------|
| | Min. | Max. | Min. | Max. | | Min. | Max. | Min. | Max. |
| A | 0.1732 | 0.1811 | 4.40 | 4.60 | F | 0.0583 | 0.0598 | 1.48 | 1.527 |
| B | 0.1594 | 0.1673 | 4.05 | 4.25 | G | 0.1165 | 0.1197 | 2.96 | 3.04 |
| C | 0.0591 | 0.0663 | 1.50 | 1.70 | H | 0.0551 | 0.0630 | 1.40 | 1.60 |
| D | 0.0945 | 0.1024 | 2.40 | 2.60 | I | 0.0138 | 0.0161 | 0.35 | 0.41 |
| E | 0.01417 | 0.0201 | 0.36 | 0.51 | | | | | |

Notes: 1.Controlling dimension: millimeters.
 2.Maximum lead thickness includes lead finish thickness, and minimum lead thickness is the minimum thickness of base material.
 3.If there is any question with packing specification or packing method, please contact your local CYStek sales office.

Material:

- Lead: 42 Alloy ; solder plating
- Mold Compound: Epoxy resin family, flammability solid burning class: UL94V-0

Important Notice:

- All rights are reserved. Reproduction in whole or in part is prohibited without the prior written approval of CYStek.
- CYStek reserves the right to make changes to its products without notice.
- CYStek **semiconductor products are not warranted to be suitable for use in Life-Support Applications, or systems.**
- CYStek assumes no liability for any consequence of customer product design, infringement of patents, or application assistance.