

BRA144ETP Series

PNP Built-in Resistor Transistor TO-92 Series
Inverter, Driver, Switching

HITACHI

ADE-208-1446B (Z)

Rev.2
Sep. 2001

Features

- Built-in Resistor Type
- Simplifies Circuit Design
- Reduces Board Space
- Complementary pair with BRC144ETP series

Outline

TO-92

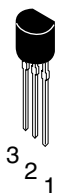

1. Ground (Emitter)
2. Output (Collector)
3. Input (Base)

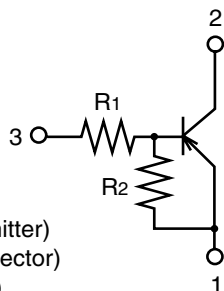

Note: Input resistance is shown in below

Device	R1 (k Ω)	R2 (k Ω)
BRA144ETP	47	47
BRA124ETP	22	22
BRA114ETP	10	10
BRA143ETP	4.7	4.7
BRA123ETP	2.2	2.2

BRA144ETP Series

Absolute Maximum Ratings

($T_a = 25^\circ\text{C}$)

Item		Symbol	Ratings	Unit
Supply voltage		V_{CC}	-50	V
Input voltage	BRA144ETP	V_I	+10 to -50	V
	BRA124ETP		+10 to -50	
	BRA114ETP		+10 to -50	
	BRA143ETP		+10 to -35	
	BRA123ETP		+10 to -24	
Output current		I_O	-100	mA
Total power dissipation		P_T	400	mW
Storage temperature		Tstg	-55 to +150	$^\circ\text{C}$

Electrical Characteristics

(Ta = 25°C)

Item		Symbol	Min	Typ	Max	Unit	Test conditions	
Input on voltage	BRA144ETP	$V_{I(on)}$	-1.5	—	-4.5	V	$V_{cc} = -0.3 V,$ $I_o = -5 mA$	
	BRA124ETP		-1.3	—	-3.0			
	BRA114ETP		-1.2	—	-2.4			
	BRA143ETP		-1.1	—	-2.0			
	BRA123ETP		-1.1	—	-1.8			
Input off voltage	BRA144ETP	$V_{I(off)}$	-1.0	—	-1.5	V	$V_{cc} = -5 V,$ $I_o = -100 \mu A$	
	BRA124ETP		-1.0	—	-1.5			
	BRA114ETP		-1.0	—	-1.5			
	BRA143ETP		-1.0	—	-1.5			
	BRA123ETP		-1.0	—	-1.5			
Output saturation current		$V_{O(on)}$	—	—	-0.3	V	$I_o = -10 mA,$ $I_i = -0.5 mA$	
Output cutoff current		$I_{O(off)}$	—	—	-0.5	μA	$V_{cc} = -50 V, I_i = 0$	
DC current transfer ratio	BRA144ETP	G_i	70	—	—		$V_{cc} = -5 V, I_o = -5 mA$	
	BRA124ETP		56	—	—			
	BRA114ETP		30	—	—			
	BRA143ETP		20	—	—			$V_{cc} = -5 V, I_o = -10 mA$
	BRA123ETP		20	—	—			$V_{cc} = -5 V, I_o = -20 mA$
Input resistance	BRA144ETP	R_i	33	47	61	k Ω		
	BRA124ETP		15	22	28			
	BRA114ETP		7	10	13			
	BRA143ETP		3.3	4.7	6.1			
	BRA123ETP		1.5	2.2	2.8			
Resistance ratio		R_1/R_2	0.8	1.0	1.2			

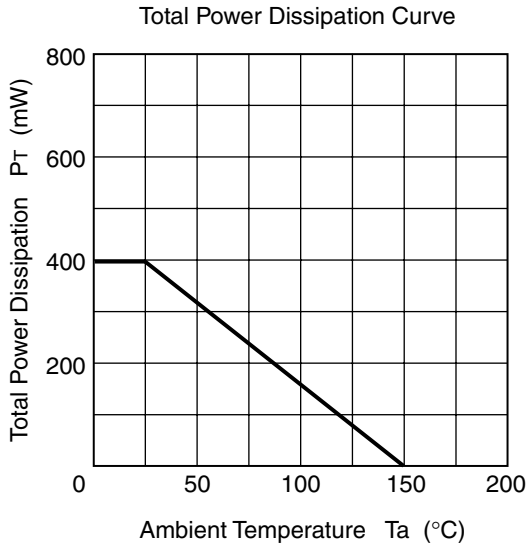

Main Characteristics (BRA144ETP)

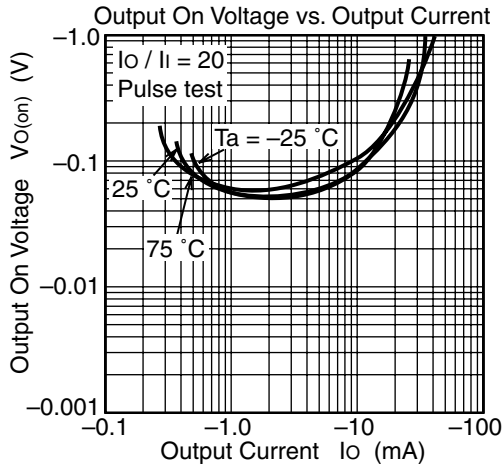
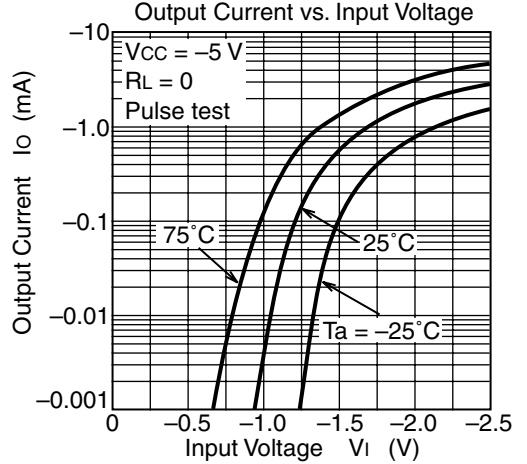
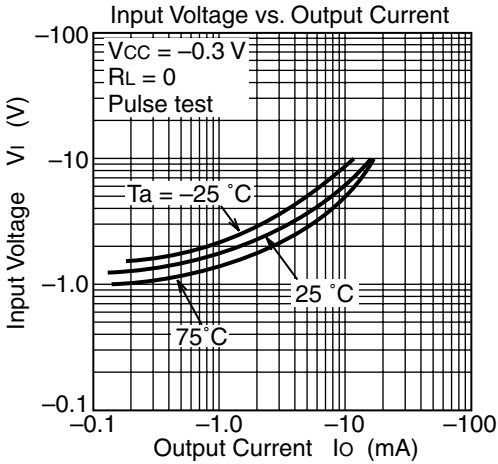
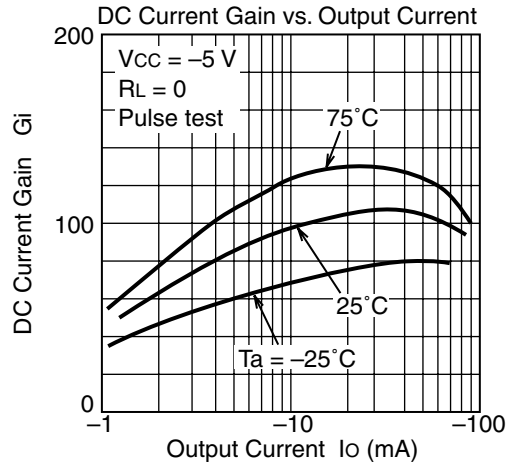
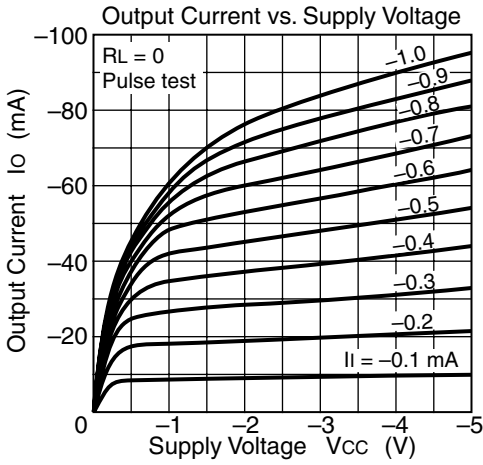

Main Characteristics (BRA124ETP)

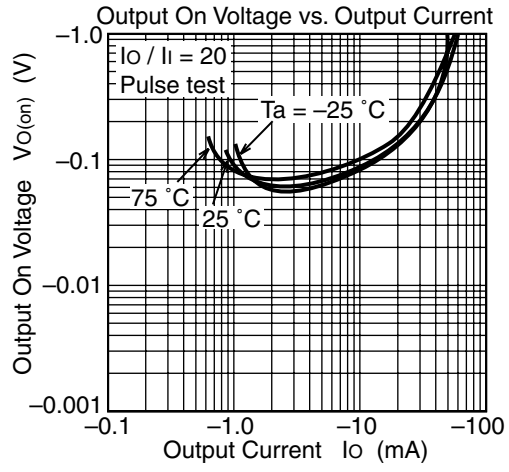
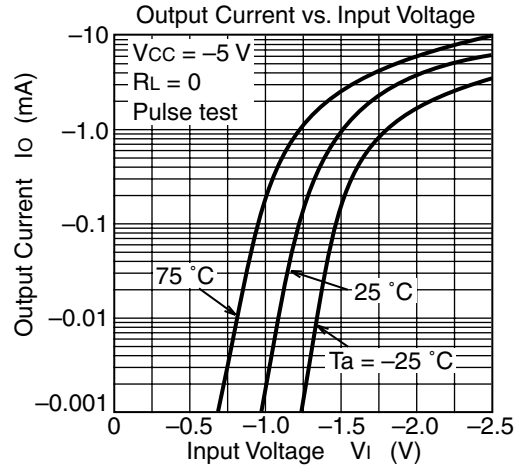
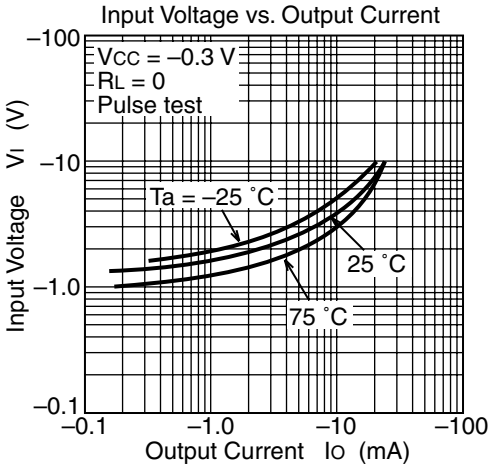
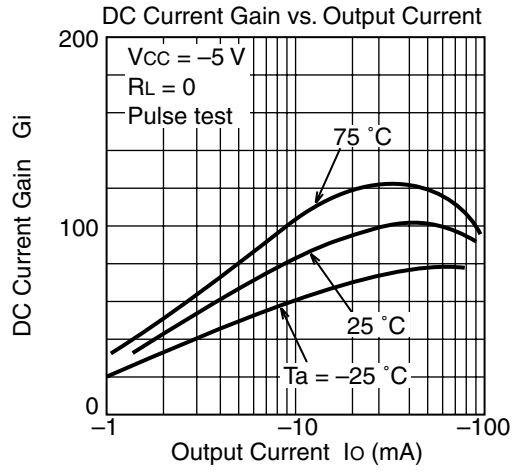
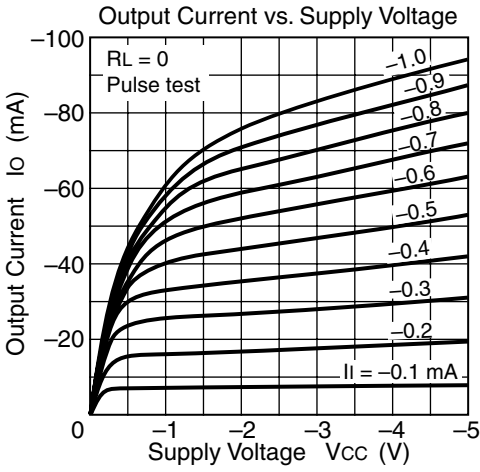

Main Characteristics (BRA114ETP)

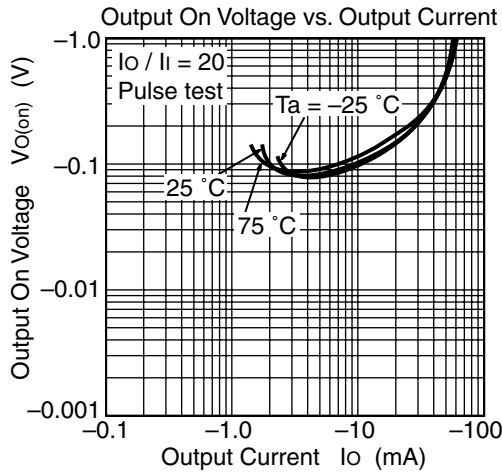
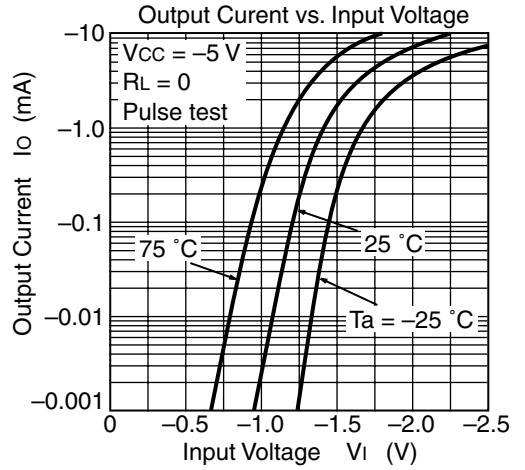
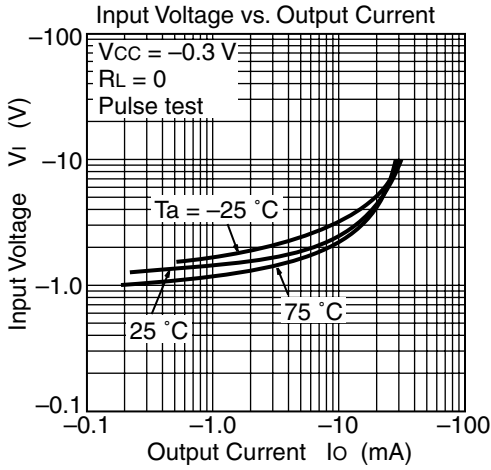
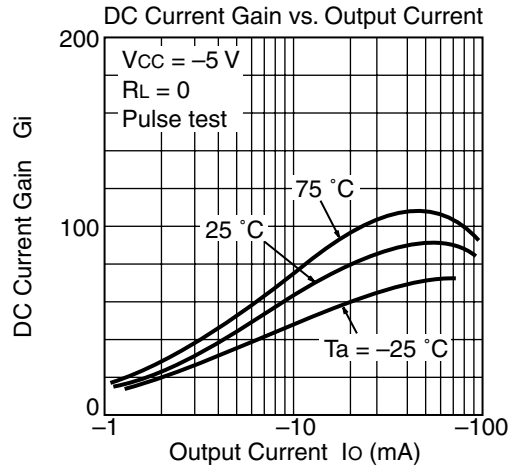
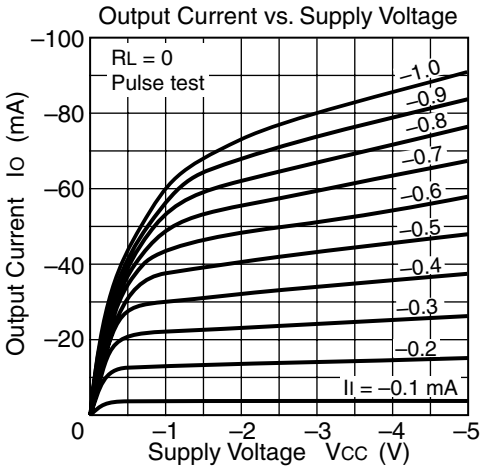

Main Characteristics (BRA143ETP)

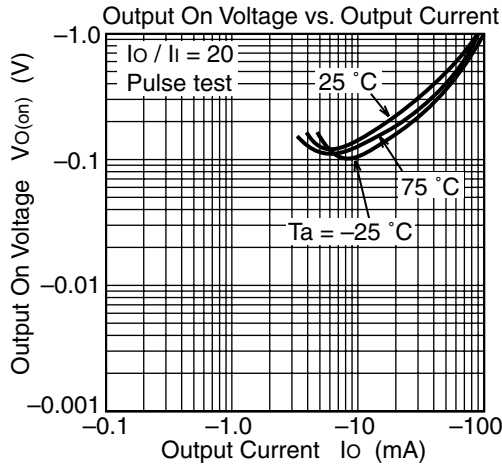
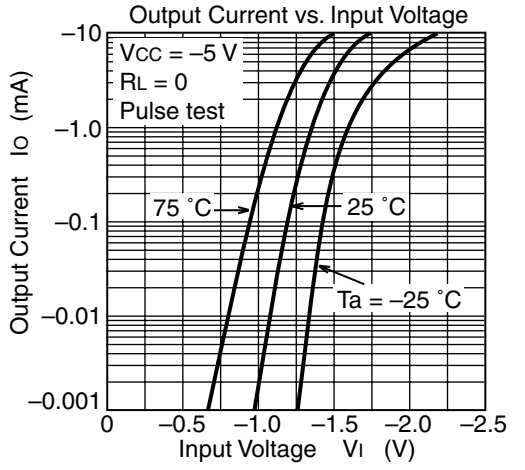
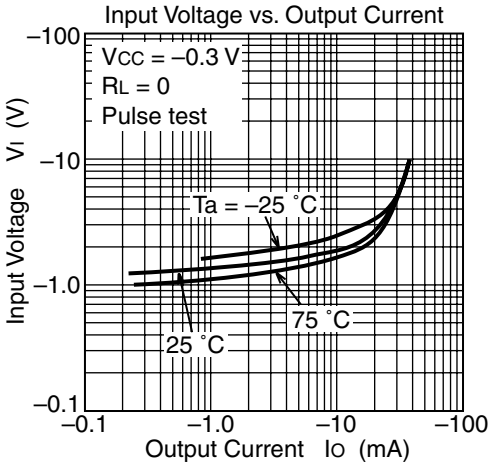
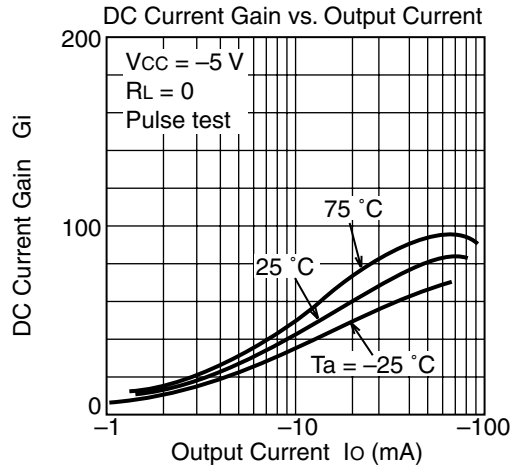
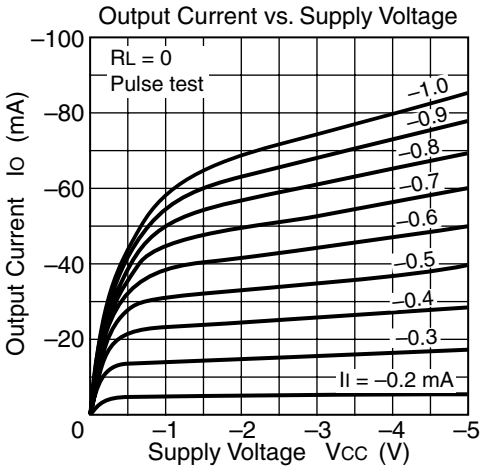

Main Characteristics (BRA123ETP)

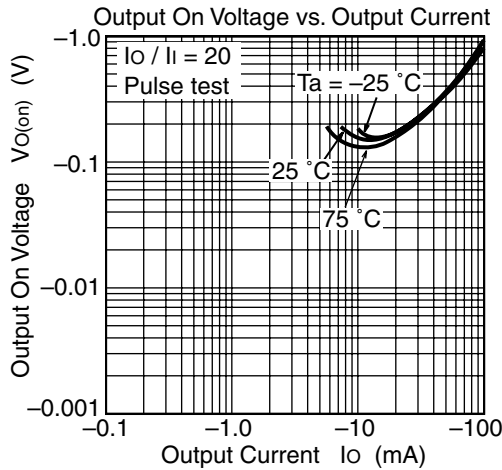
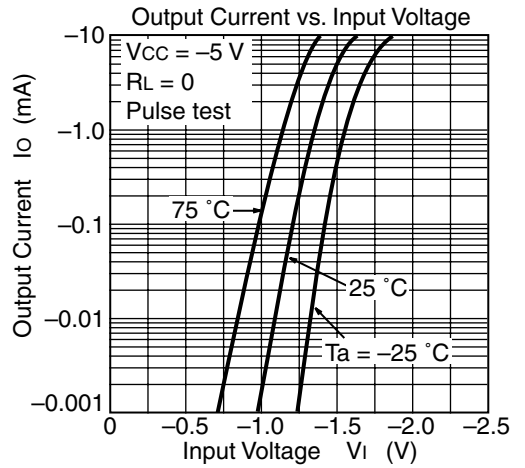
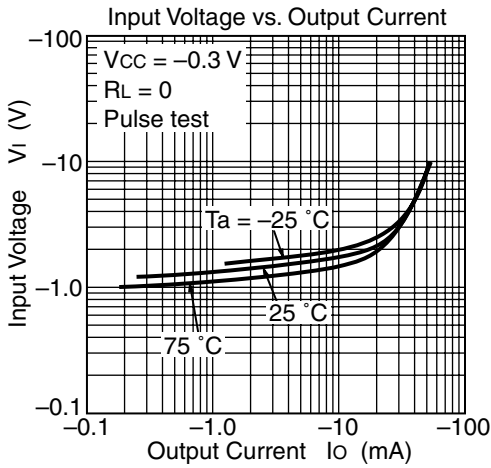
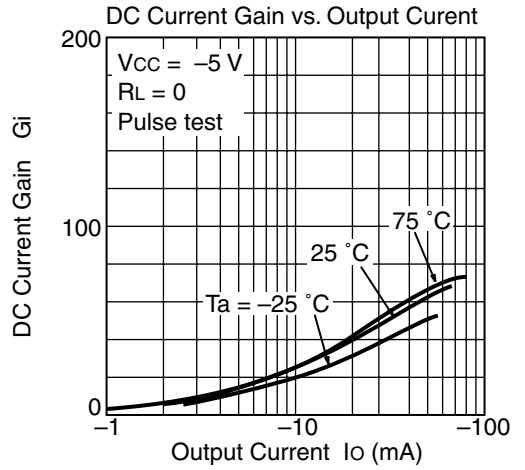
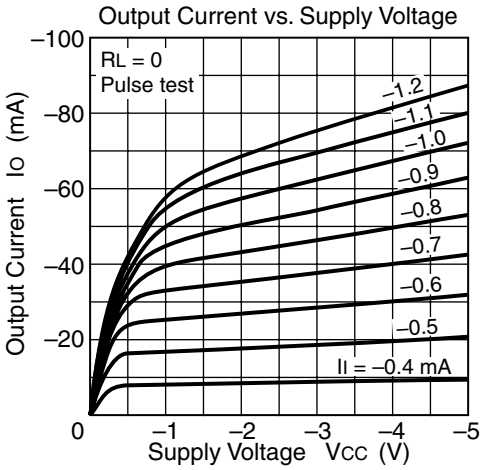

Taping Specification

Purchasing Identification Code: Type No. + Grade + TZ

The tape is held in every 25 pitches to a hold box.

Packing quantity is 2500 pieces.

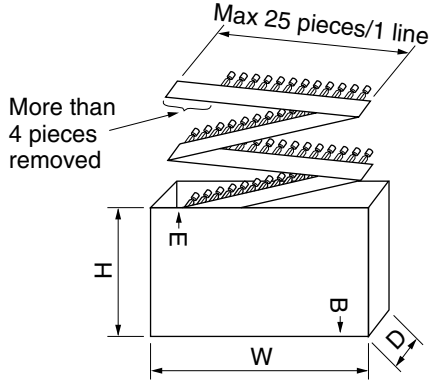

W	H	D	Unit: mm
336	262	47	

Package Dimensions

As of January, 2001
Unit: mm

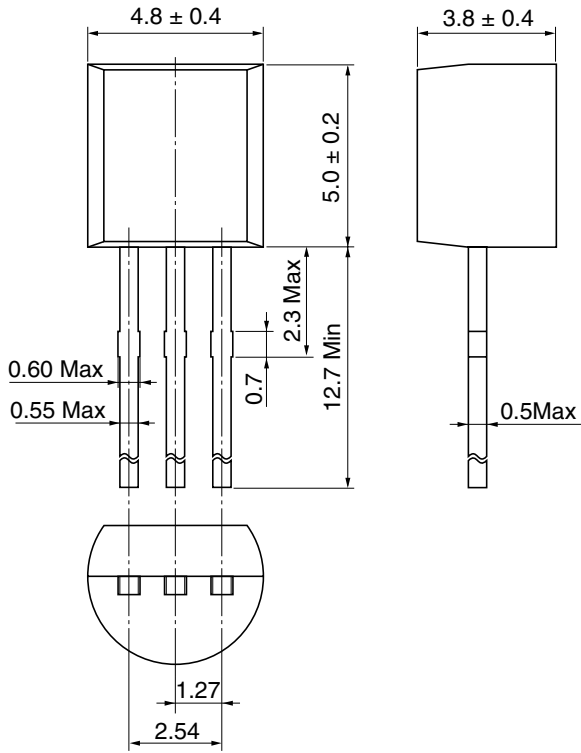

Hitachi Code	TO-92 (1)
JEDEC	Conforms
EIAJ	Conforms
Mass (reference value)	0.25 g

Disclaimer

1. Hitachi neither warrants nor grants licenses of any rights of Hitachi's or any third party's patent, copyright, trademark, or other intellectual property rights for information contained in this document. Hitachi bears no responsibility for problems that may arise with third party's rights, including intellectual property rights, in connection with use of the information contained in this document.
2. Products and product specifications may be subject to change without notice. Confirm that you have received the latest product standards or specifications before final design, purchase or use.
3. Hitachi makes every attempt to ensure that its products are of high quality and reliability. However, contact Hitachi's sales office before using the product in an application that demands especially high quality and reliability or where its failure or malfunction may directly threaten human life or cause risk of bodily injury, such as aerospace, aeronautics, nuclear power, combustion control, transportation, traffic, safety equipment or medical equipment for life support.
4. Design your application so that the product is used within the ranges guaranteed by Hitachi particularly for maximum rating, operating supply voltage range, heat radiation characteristics, installation conditions and other characteristics. Hitachi bears no responsibility for failure or damage when used beyond the guaranteed ranges. Even within the guaranteed ranges, consider normally foreseeable failure rates or failure modes in semiconductor devices and employ systemic measures such as fail-safes, so that the equipment incorporating Hitachi product does not cause bodily injury, fire or other consequential damage due to operation of the Hitachi product.
5. This product is not designed to be radiation resistant.
6. No one is permitted to reproduce or duplicate, in any form, the whole or part of this document without written approval from Hitachi.
7. Contact Hitachi's sales office for any questions regarding this document or Hitachi semiconductor products.

Sales Offices

HITACHI

Hitachi, Ltd.

Semiconductor & Integrated Circuits
Nippon Bldg., 2-6-2, Ohte-machi, Chiyoda-ku, Tokyo 100-0004, Japan
Tel: (03) 3270-2111 Fax: (03) 3270-5109

URL <http://www.hitachisemiconductor.com/>

For further information write to:

Hitachi Semiconductor (America) Inc. 179 East Tasman Drive San Jose, CA 95134 Tel: <1> (408) 433-1990 Fax: <1>(408) 433-0223	Hitachi Europe Ltd. Electronic Components Group Whitebrook Park Lower Cookham Road Maidenhead Berkshire SL6 8YA, United Kingdom Tel: <44> (1628) 585000 Fax: <44> (1628) 585200
--	--

Hitachi Asia Ltd. Hitachi Tower 16 Collyer Quay #20-00 Singapore 049318 Tel : <65>-538-6533/538-8577 Fax : <65>-538-6933/538-3877 URL : http://semiconductor.hitachi.com.sg

Hitachi Asia (Hong Kong) Ltd. Group III (Electronic Components) 7/F., North Tower World Finance Centre, Harbour City, Canton Road Tsim Sha Tsui, Kowloon Hong Kong Tel : <852>-(2)-735-9218 Fax : <852>-(2)-730-0281 URL : http://semiconductor.hitachi.com.hk
--

Hitachi Europe GmbH Electronic Components Group Dornacher Straße 3 D-85622 Feldkirchen Postfach 201, D-85619 Feldkirchen Germany Tel: <49> (89) 9 9180-0 Fax: <49> (89) 9 29 30 00

Hitachi Asia Ltd. (Taipei Branch Office) 4/F, No. 167, Tun Hwa North Road Hung-Kuo Building Taipei (105), Taiwan Tel : <886>-(2)-2718-3666 Fax : <886>-(2)-2718-8180 Telex : 23222 HAS-TP URL : http://www.hitachi.com.tw

Copyright © Hitachi, Ltd., 2001. All rights reserved. Printed in Japan.
Colophon 5.0