

### FEATURES

- 26 dB Gain
- +24 dBm Linear Output Power
- 2.3 % EVM (OFDM Modulation)
- +5 V to +6 V Supply
- High Efficiency
- Integrated Step Attenuator
- Integrated Output Power Detector
- 50Ω Matched RF Ports
- RoHS Compliant 4.5 mm x 4.5 mm x 1.4 mm Surface Mount Module

### APPLICATIONS

- WiMAX transceivers that support the IEEE 802.16-2004 and ETSI EN301-021 standards
- Broadband Wireless Applications (BWA)

### PRODUCT DESCRIPTION

The ANADIGICS AWM6431 WiMAX Power Amplifier is a high performance device that delivers exceptional linearity and efficiency at high levels of output power. Designed to operate in the upper portion of the 3.5 GHz band, it supports the IEEE 802.16-2004 and ETSI EN301-021 wireless standards.

The device requires only a single +5 V to +6 V supply and a low-current reference input. An integrated detector can be used to monitor output power, and an integrated 20 dB step attenuator enables gain

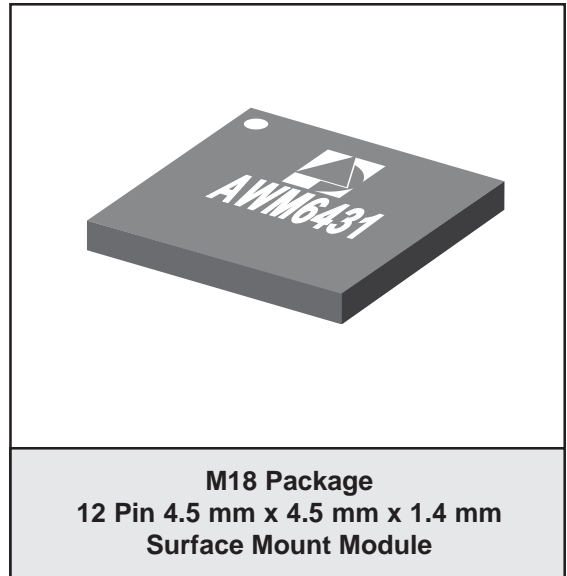

control. No external circuits are required for biasing or RF impedance matching, thus reducing external component costs and facilitating circuit board designs.

The AWM6431 is manufactured using advanced InGaP HBT technology that offers state-of-the-art reliability, temperature stability and ruggedness. It is optimized for use in a 50 Ω system, and is offered in a 4.5 mm x 4.5 mm x 1.4 mm surface mount module.

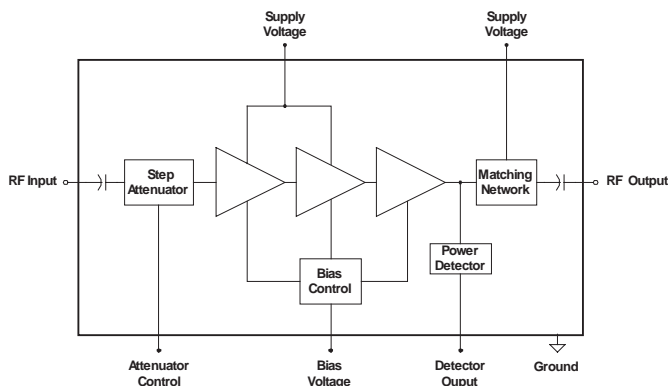

**Figure 1: Functional Block Diagram**

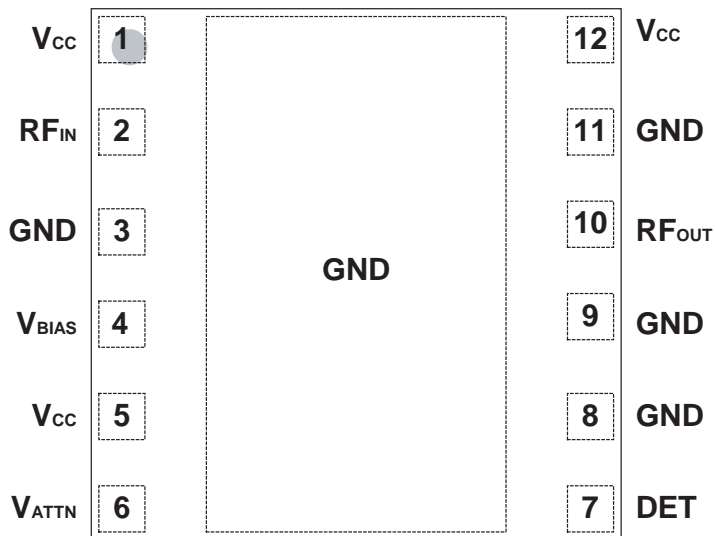

Figure 2: Pinout (X-ray Top View)

Table 1: Pin Description

PIN	NAME	DESCRIPTION
1	V <sub>CC</sub>	Supply Voltage
2	RF <sub>IN</sub>	RF Input
3	GND	Ground
4	V <sub>BIAS</sub>	Bias/Shutdown
5	V <sub>CC</sub>	Supply Voltage
6	V <sub>ATTN</sub>	Attenuator Control
7	DET	Detector Output
8	GND	Ground
9	GND	Ground
10	RF <sub>OUT</sub>	RF Output
11	GND	Ground
12	V <sub>CC</sub>	Supply Voltage

## ELECTRICAL CHARACTERISTICS

Table 2: Absolute Minimum and Maximum Ratings

PARAMETER	MIN	MAX	UNIT	COMMENTS
Supply Voltage ( $V_{CC}$ )	0	+6.5	V	
Bias Voltage ( $V_{BIAS}$ )	0	+3.3	V	
Attenuator Control Voltage ( $V_{ATTN}$ )	0	+3.7	V	
RF Input Power	-	0	dBm	OFDM modulated signal
ESD Rating	Class 1A Class 3	- -	- -	HBM CDM
MSL Level	3 4	- -	- -	235 °C Peak Reflow 250 °C Peak Reflow
Storage Temperature	-40	+150	°C	

Stresses in excess of the absolute ratings may cause permanent damage. Functional operation is not implied under these conditions. Exposure to absolute ratings for extended periods of time may adversely affect reliability.

Table 3: Operating Ranges

PARAMETER	MIN	TYP	MAX	UNIT	COMMENTS
Operating Frequency (f)	3500	-	3800	MHz	
Supply Voltage ( $V_{CC}$ )	+5.0	-	+6.0	V	
Bias Voltage ( $V_{BIAS}$ )	+2.9 0	+3.0 -	+3.1 +0.7	V	PA "on" PA "shut down"
Attenuator Control Voltage ( $V_{ATTN}$ ) Logic High Logic Low	+2.3 0	- -	+3.7 +0.7	V	Attenuator enabled Nominal gain
RF Output Power ( $P_{OUT}$ )	-	+24	-	dBm	
Case Temperature ( $T_C$ )	-40	-	+85	°C	

The device may be operated safely over these conditions; however, parametric performance is guaranteed only over the conditions defined in the electrical specifications.

**Table 4: Electrical Specifications**  
**(T<sub>c</sub> = +25 °C, V<sub>CC</sub> = +6.0 V, V<sub>BIAS</sub> = +3.0 V, f = 3.8 GHz, 50 Ω system)**

PARAMETER	MIN	TYP	MAX	UNIT	COMMENTS
Gain	25	26	30	dB	
Attenuator Step	18	20	22	dB	
Output Power Meets Spectrum Mask	+24	-	-	dBm	ETSI EN301-021 Type G
EVM	-	2.3	2.5	%	at +24 dBm P <sub>OUT</sub>
Output P1dB	-	+31	-	dBm	CW
Output IP3	-	+43	-	dBm	two CW tones, +21 dBm output per tone
Harmonics	-	-20	-	dBm	at +24 dBm P <sub>OUT</sub>
Power-Added Efficiency	-	12.8	-	%	at +24 dBm P <sub>OUT</sub>
Power Detector Voltage at +24 dBm P <sub>OUT</sub> at +14 dBm P <sub>OUT</sub>	- -	+2.6 +0.6	- -	V	High impedance load
Quiescent Current	-	87	120	mA	
Current Consumption V <sub>CC</sub> V <sub>BIAS</sub> V <sub>ATTN</sub>	- - -	305 7.4 0.2	365 8 1.0	mA	P <sub>OUT</sub> = +24 dBm Logic High = +3.3 V
Leakage Current	-	1.7	3.0	mA	PA shut down (V <sub>BIAS</sub> = 0V)

Note:

1. All RF measurements performed with an 802.11g 54 Mbps OFDM signal unless otherwise noted.

PERFORMANCE DATA

**Figure 3: Gain vs. Output Power**  
( $T_C = +25\text{ }^\circ\text{C}$ ,  $V_{CC} = +6.0\text{ V}$ ,  $V_{BIAS} = +3.0\text{ V}$ ,  
 $f = 3.7\text{ GHz}$ , 54 Mbps OFDM Modulation)

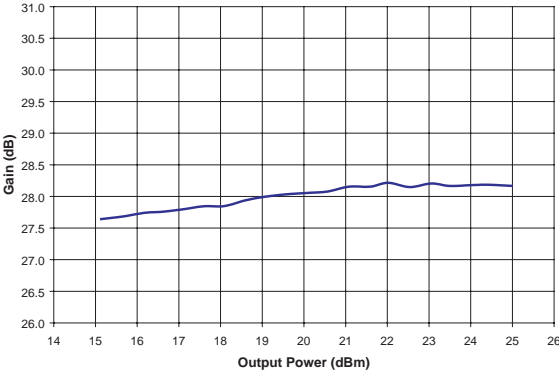

**Figure 4: Gain vs. Frequency**  
( $T_C = +25\text{ }^\circ\text{C}$ ,  $V_{CC} = +6.0\text{ V}$ ,  $V_{BIAS} = +3.0\text{ V}$ ,  
 $P_{OUT} = +24\text{ dBm}$ , 54 Mbps OFDM Modulation)

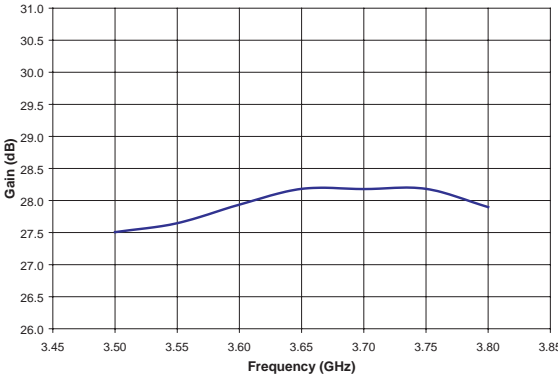

**Figure 5: Uncorrected EVM vs. Output Power**  
( $T_C = +25\text{ }^\circ\text{C}$ ,  $V_{CC} = +6.0\text{ V}$ ,  $V_{BIAS} = +3.0\text{ V}$ , 54 Mbps  
OFDM Modulation, system EVM Approx. 0.8 %)

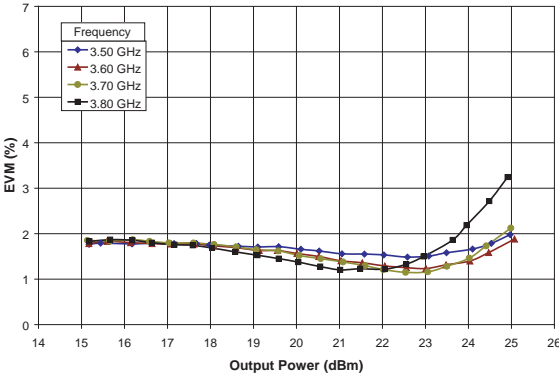

**Figure 6: Uncorrected EVM vs. Frequency**  
( $T_C = +25\text{ }^\circ\text{C}$ ,  $V_{CC} = +6.0\text{ V}$ ,  $V_{BIAS} = +3.0\text{ V}$ , 54 Mbps  
OFDM Modulation, system EVM Approx. 0.8 %)

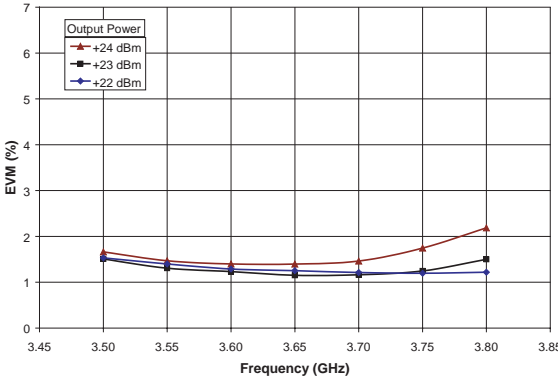

**Figure 7: Detector Voltage vs. Output Power**  
( $T_C = +25\text{ }^\circ\text{C}$ ,  $V_{CC} = +6.0\text{ V}$ ,  $V_{BIAS} = +3.0\text{ V}$ ,  
 $f = 3.7\text{ GHz}$ , 54 Mbps OFDM Modulation)

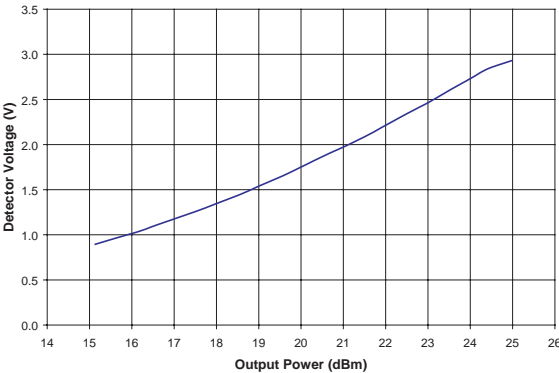

**Figure 8: Detector Voltage vs. Frequency**  
( $T_C = +25\text{ }^\circ\text{C}$ ,  $V_{CC} = +6.0\text{ V}$ ,  $V_{BIAS} = +3.0\text{ V}$ ,  
54 Mbps OFDM Modulation)

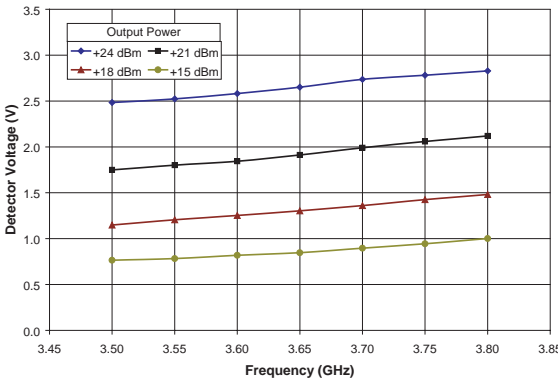

**Figure 9: Effects of Bias Voltage ( $V_{BIAS}$ ) on EVM**  
 ( $T_C = +25\text{ }^\circ\text{C}$ ,  $V_{CC} = +6.0\text{ V}$ ,  $f = 3.7\text{ GHz}$ , 54 Mbps OFDM Modulation, system EVM Approx. 0.8 %)

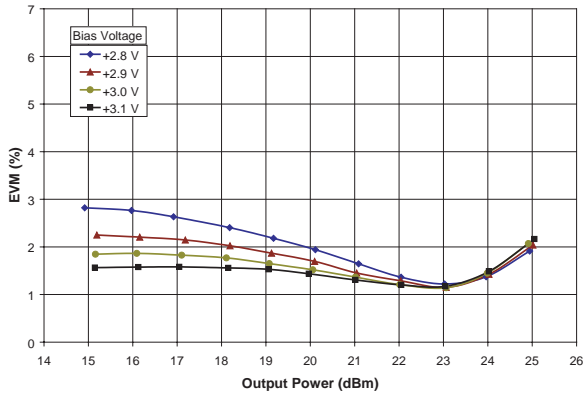

**Figure 10: Effects of Supply Voltage ( $V_{CC}$ ) on EVM**  
 ( $T_C = +25\text{ }^\circ\text{C}$ ,  $V_{BIAS} = +3.0\text{ V}$ ,  $f = 3.7\text{ GHz}$ , 54 Mbps OFDM Modulation, system EVM Approx. 0.8 %)

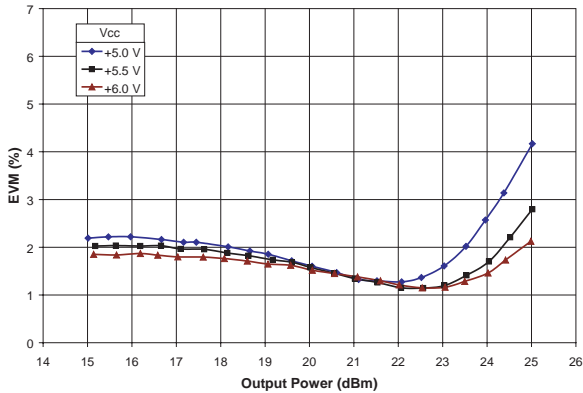

**Figure 11: Effects of Case Temperature on EVM**  
 ( $V_{CC} = +6.0\text{ V}$ ,  $V_{BIAS} = +3.0\text{ V}$ ,  $f = 3.7\text{ GHz}$ , 54 Mbps OFDM Modulation, system EVM Approx. 0.8 %)

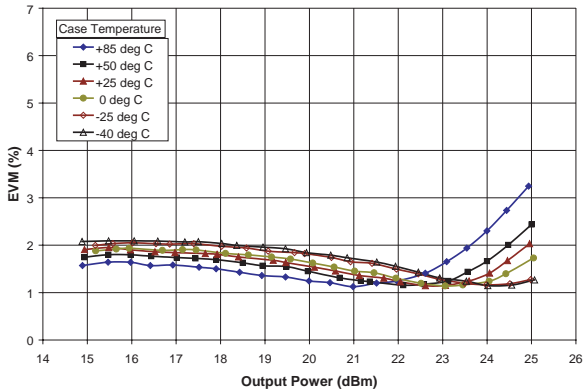

**Figure 12: Gain vs. Bias Voltage ( $V_{BIAS}$ )**  
( $T_C = +25\text{ }^\circ\text{C}$ ,  $V_{CC} = +6.0\text{ V}$ ,  $f = 3.7\text{ GHz}$ ,  
54 Mbps OFDM Modulation)

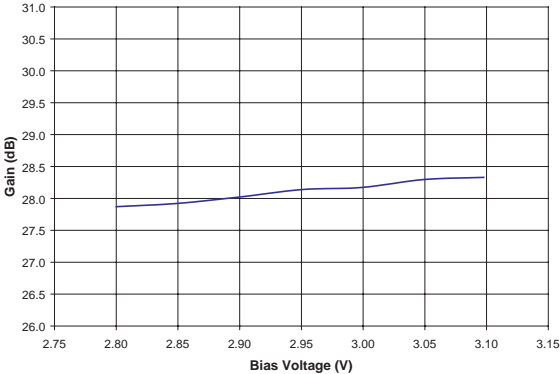

**Figure 13: Gain vs. Case Temperature**  
( $V_{CC} = +6.0\text{ V}$ ,  $V_{BIAS} = +3.0\text{ V}$ ,  $f = 3.7\text{ GHz}$ ,  
 $P_{OUT} = +23\text{ dBm}$ , 54 Mbps OFDM Modulation)

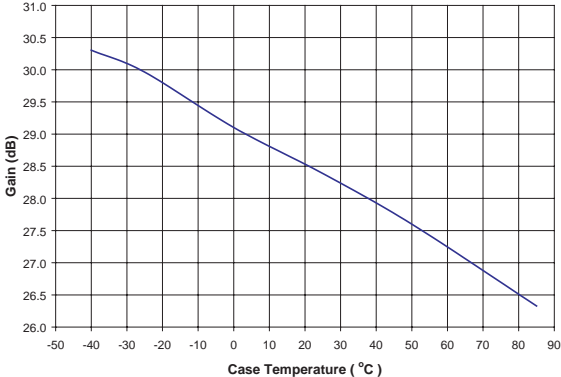

**Figure 14: Supply Current vs. Output Power**  
( $T_C = +25\text{ }^\circ\text{C}$ ,  $V_{CC} = +6.0\text{ V}$ ,  $V_{BIAS} = +3.0\text{ V}$ ,  
 $f = 3.7\text{ GHz}$ , 54 Mbps OFDM Modulation)

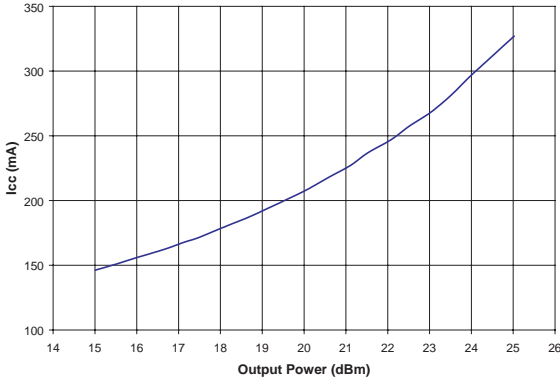

**Figure 15: Supply Current vs. Case Temperature**  
( $V_{CC} = +6.0\text{ V}$ ,  $V_{BIAS} = +3.0\text{ V}$ ,  $f = 3.7\text{ GHz}$ ,  
 $P_{OUT} = +23\text{ dBm}$ , 54 Mbps OFDM Modulation)

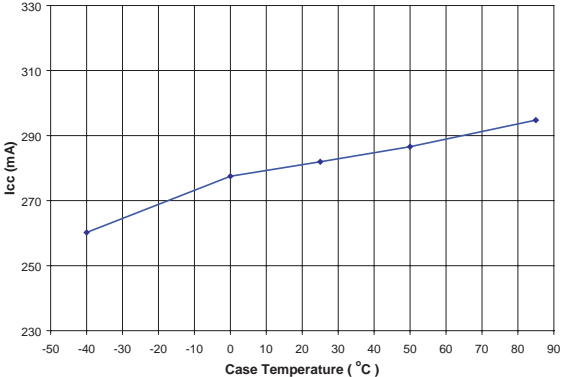

**APPLICATION INFORMATION**

**Transmit Disable and Attenuator Control**

The power amplifier is disabled by setting  $V_{BIAS}$  below +0.7 V. The step attenuator is enabled by applying a logic high to  $V_{ATTN}$ ; the PA exhibits nominal gain when a logic low is applied to  $V_{ATTN}$ .

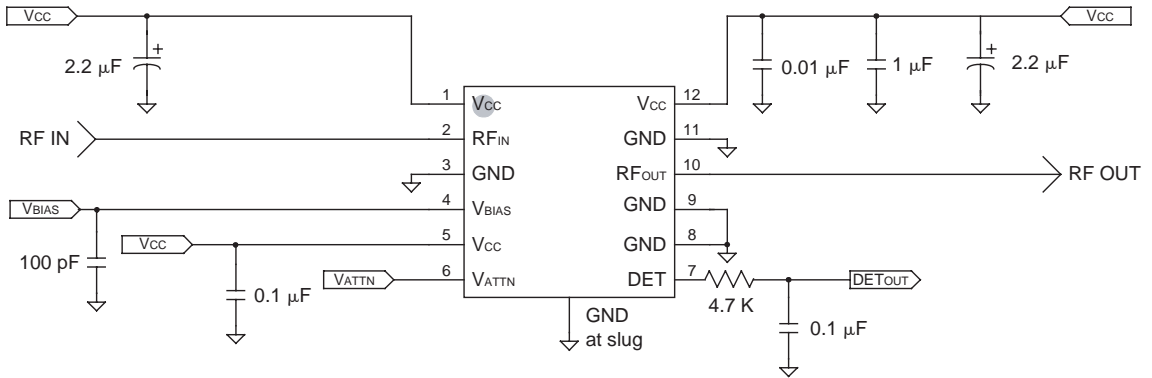

**Figure 16: Application Circuit**



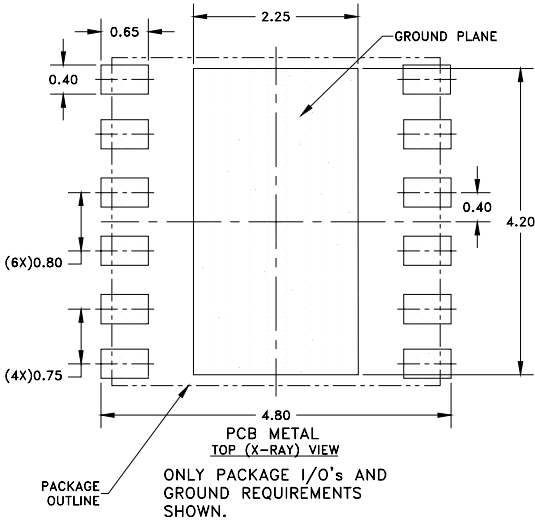

- NOTES:
- (1) UNLESS SPECIFIED, DIMENSIONS ARE SYMMETRICAL ABOUT CENTER LINES SHOWN.
  - (2) DIMENSIONS IN MILLIMETERS.

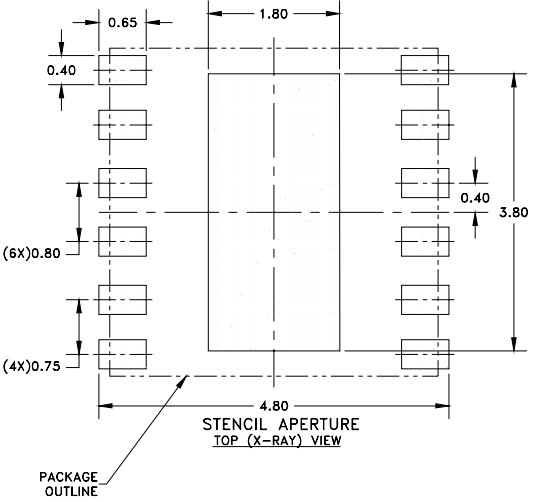
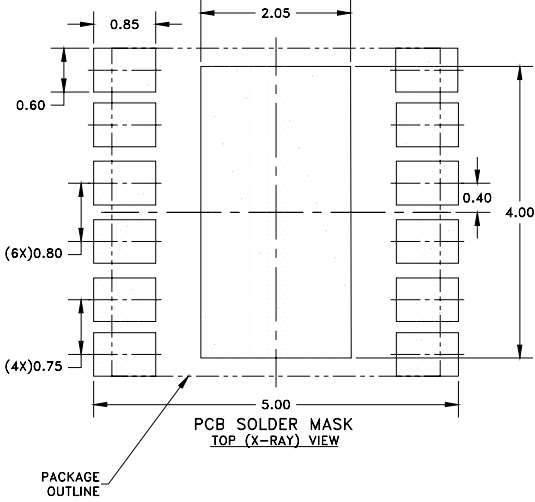
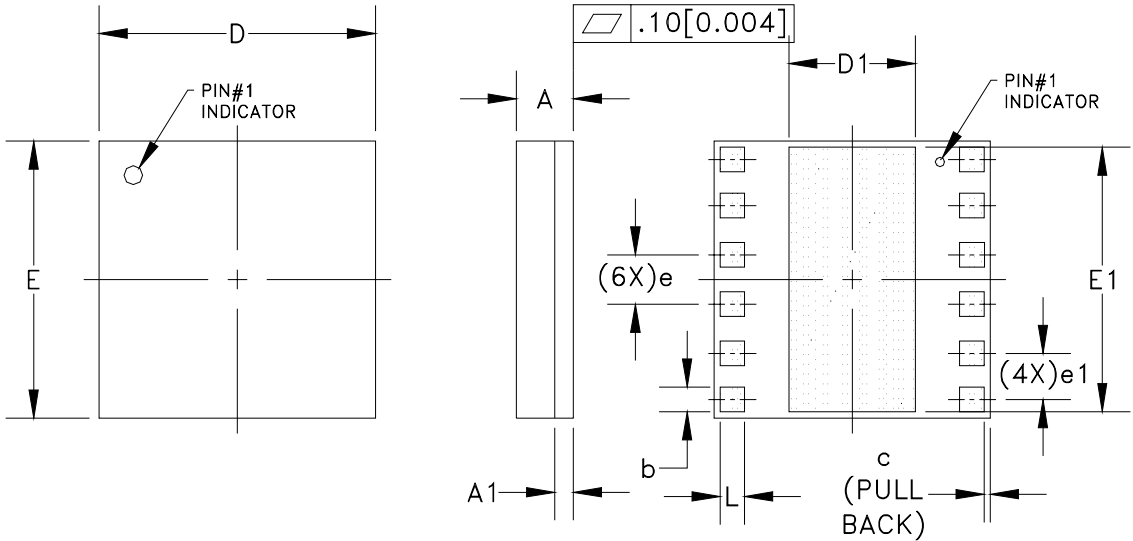

Figure 17: Land Pattern

PACKAGE OUTLINE



S <sub>N</sub> B <sub>OL</sub>	MILLIMETERS			INCHES			NOTE
	MIN.	NOM.	MAX.	MIN.	NOM.	MAX.	
A	1.26	1.41	1.56	0.049	0.055	0.061	-
A1	-	0.30	-	-	0.012	-	-
b	0.32	-	0.52	0.013	-	0.020	3
c	-	0.10	-	-	0.004	-	-
D	4.38	4.50	4.62	0.172	0.177	0.182	-
D1	1.97	-	2.13	0.078	-	0.084	-
E	4.38	4.50	4.62	0.172	0.177	0.182	-
E1	4.22	-	4.38	0.166	-	0.172	-
e	-	0.80	-	-	0.032	-	3
e1	-	0.75	-	-	0.030	-	3,4
L	0.32	-	0.52	0.013	-	0.020	3

NOTES:

1. CONTROLLING DIMENSIONS: MILLIMETERS
2. UNLESS SPECIFIED TOLERANCE=±0.076[0.003].
3. PADS (INCLUDING CENTER) SHOWN UNIFORM SIZE FOR REFERENCE ONLY. ACTUAL PAD SIZE AND LOCATION WILL VARY WITHIN MIN. AND MAX. DIMENSIONS ACCORDING TO SPECIFIC LAMINATE DESIGN.
4. DIMENSION e1 FOUR CORNERS.

Figure 18: M18 Package Outline - 12 Pin 4.5 mm x 4.5 mm x 1.4 mm Surface Mount Module

NOTES

**ORDERING INFORMATION**

ORDER NUMBER	TEMPERATURE RANGE	PACKAGE DESCRIPTION	COMPONENT PACKAGING
AWM6431RM18P8	-40 °C to +85 °C	RoHS-compliant 12 Pin 4.5 mm x 4.5 mm x 1.4 mm Surface Mount Module	2,500 piece Tape and Reel

**ANADIGICS, Inc.**

141 Mount Bethel Road  
Warren, New Jersey 07059, U.S.A.

Tel: +1 (908) 668-5000

Fax: +1 (908) 668-5132

URL: <http://www.anadigics.com>

E-mail: [Mktg@anadigics.com](mailto:Mktg@anadigics.com)

**IMPORTANT NOTICE**

ANADIGICS, Inc. reserves the right to make changes to its products or to discontinue any product at any time without notice. The product specifications contained in Advanced Product Information sheets and Preliminary Data Sheets are subject to change prior to a product's formal introduction. Information in Data Sheets have been carefully checked and are assumed to be reliable; however, ANADIGICS assumes no responsibilities for inaccuracies. ANADIGICS strongly urges customers to verify that the information they are using is current before placing orders.

**WARNING**

ANADIGICS products are not intended for use in life support appliances, devices or systems. Use of an ANADIGICS product in any such application without written consent is prohibited.