

100W T10V F1

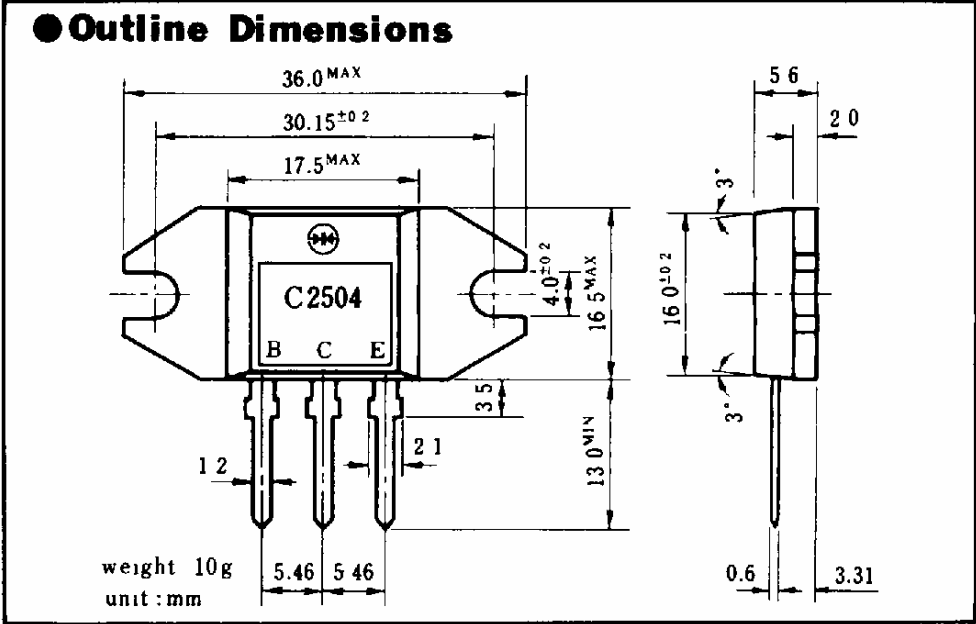

● Ratings

Item	Symbol	EIAJ. No.		Unit	
		House. No.	Conditions		
			2SC2504		
			T10V40F1		
Absolute Maximum Ratings	Storage Temperature	T _{stg}	-55 ~ +150	°C	
	Junction Temperature	T _j	+150	°C	
	Collector to Base Voltage	V _{CB0}	500	V	
	Collector to Emitter Voltage	V _{CE0}	400	V	
	Emitter to Base Voltage	V _{EB0}	7	V	
	Collector Current	DC	I _C	10	A
		Peak	I _{CP}	20	A
	Base Current	DC	I _B	4	A
Peak		I _{BP}	8	A	
Transistor Dissipation	P _T	T _C = 25°C	100	W	
Electrical Characteristics (T _C = 25°C)	Collector to Emitter Sustaining Voltage	V _{CE0(sus)}	I _C = 0.2A	MIN 400	V
	Collector Cut-off Current	I _{CB0}	At Rated Voltage	MAX 0.1	mA
		I _{CE0}	At Rated Voltage × 0.8	MAX 0.1	
	Emitter Cut-off Current	I _{EB0}	At Rated Voltage	MAX 1	mA
	Static Forward Transfer Ratio	h _{FE1}	V _{CE} = 2V I _C = 5A	MIN 15	
			STD 20		
		h _{FE2}	V _{CE} = 2V I _C = 10A	MIN 8	
			STD 10		
	Collector to Emitter Saturation Voltage	V _{CE(sat)}	I _C = 5A I _B = 0.5A	STD 0.4 MAX 0.7	V
	Base to Emitter Saturation Voltage	V _{BE(sat)}		STD 1 MAX 1.5	V
	Junction to Case Thermal Resistance	θ _{JC}	Between Junction and Case	MAX 1.25	°C/W
	Gain Bandwidth Product	f _T	V _{CE} = 10V I _C = 1A	STD 20	MHz
Turn on Time	t _{on}	I _{B1} = I _{B2} = 1A I _C = 5A	STD 0.7 MAX 1	μs	
Storage Time	t _s	R _L = 5Ω V _{BB2} = 4V	STD 2.4 MAX 3	μs	
Fall Time	t _f		STD 0.5 MAX 0.7	μs	

● Input Output transmission characteristics

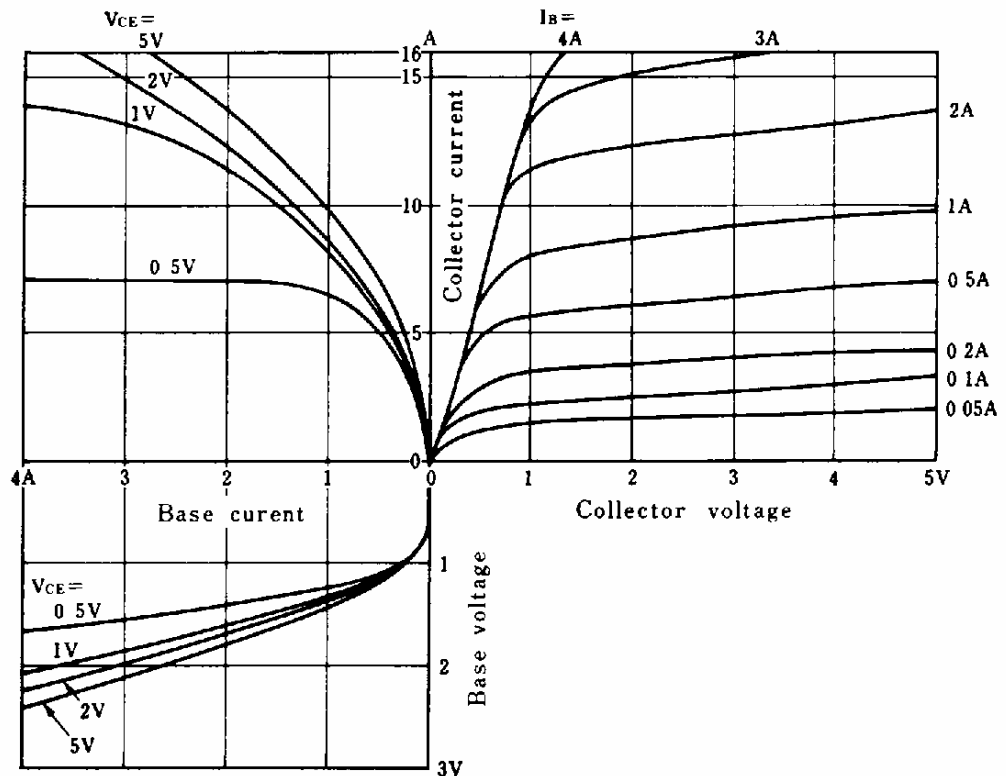

● Static forward transfer ratio vs temp. characteristics

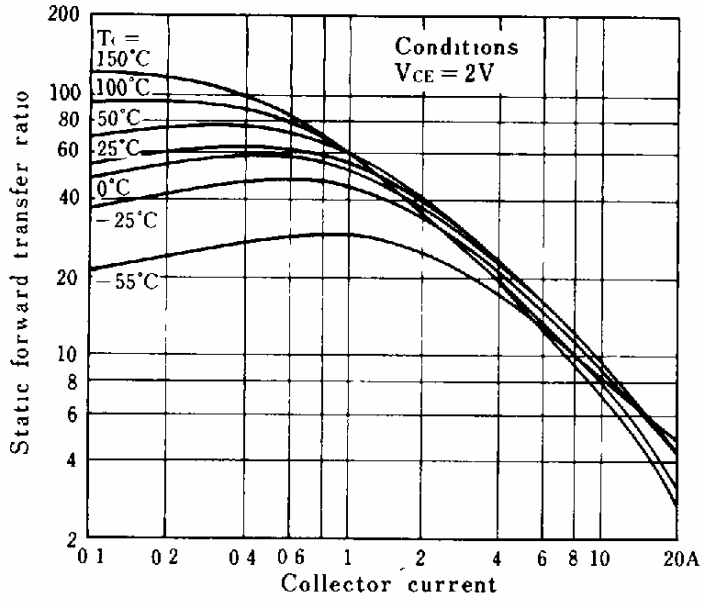

● Saturation voltage characteristics

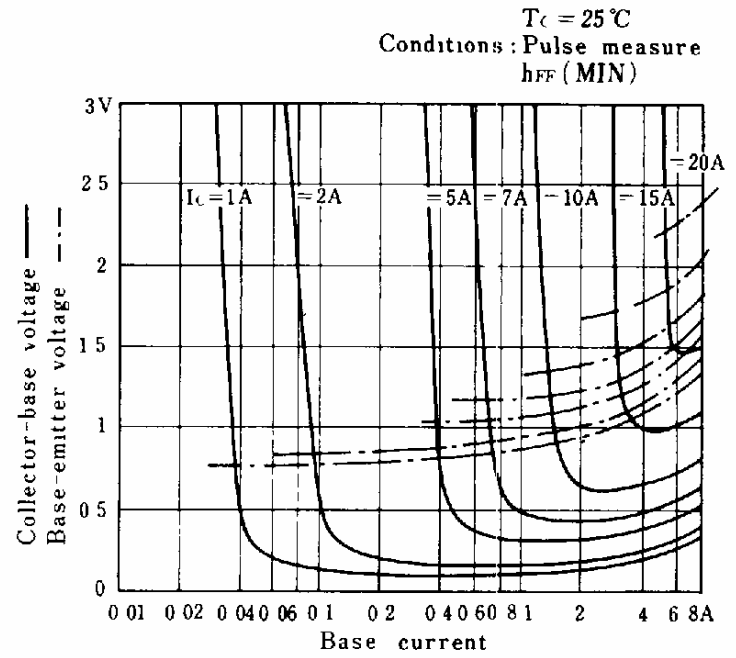

● Transition heat impedance

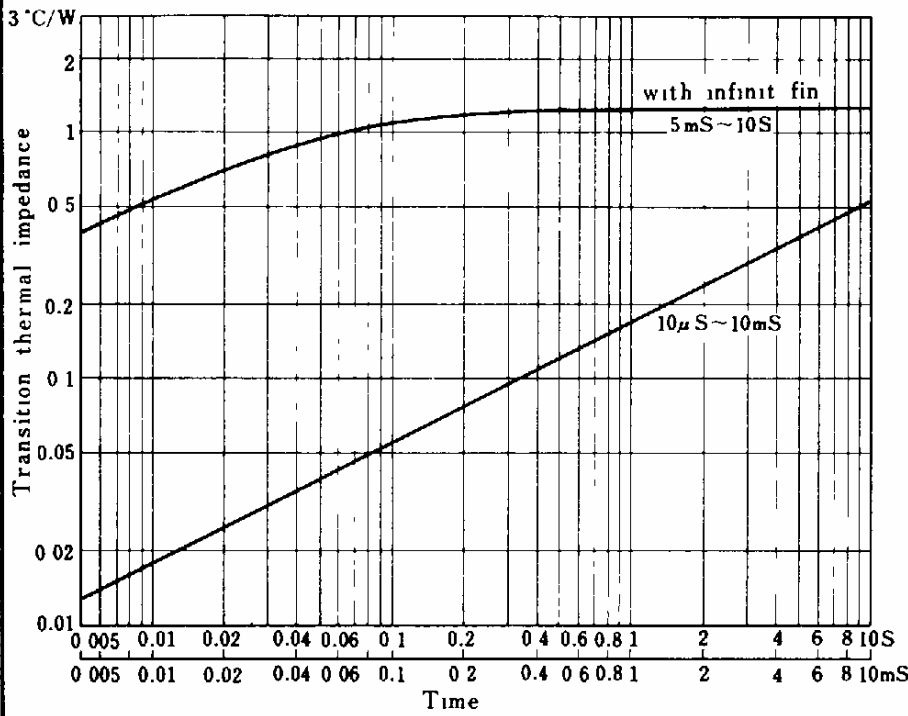

● Collector current vs Switching time

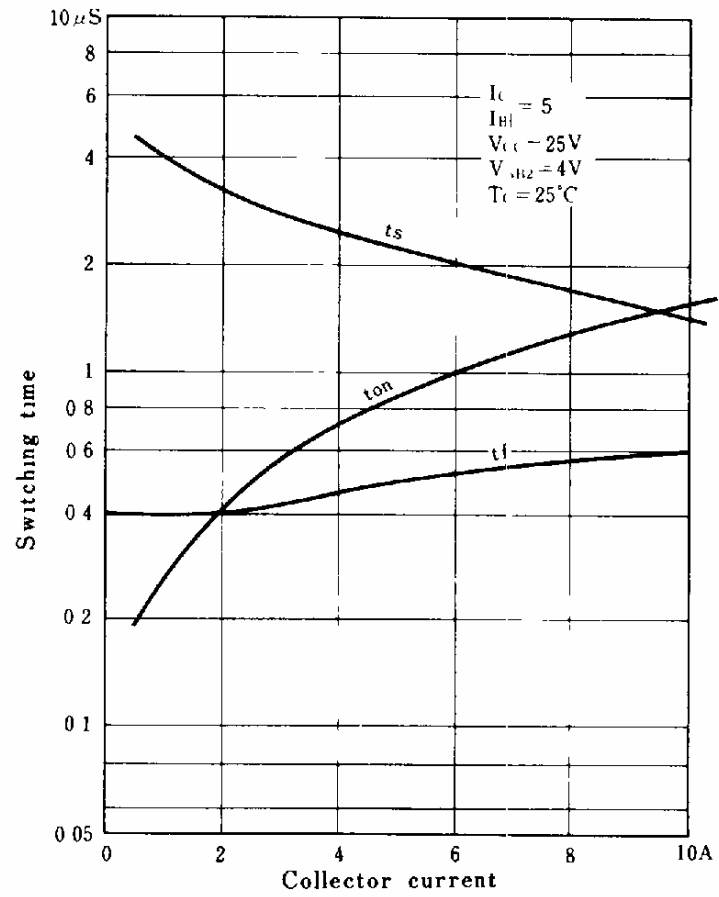

● Vcc vs Switching time

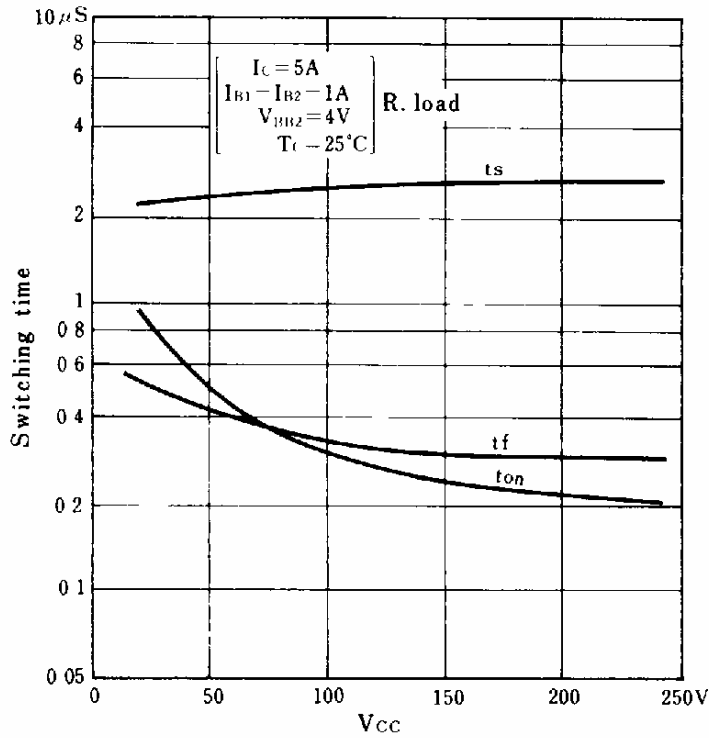

● Dissipation and Is/B derating curve

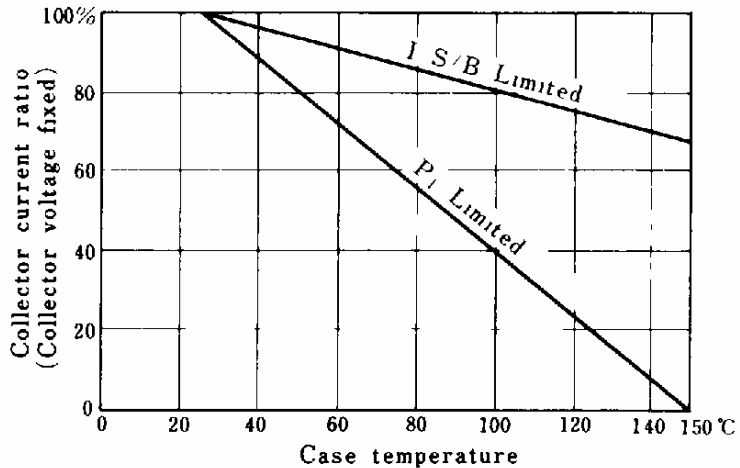

● Safe operating zone

