



SPP2341

P-Channel Enhancement Mode MOSFET

DESCRIPTION

The SPP2341 is the P-Channel logic enhancement mode power field effect transistors are produced using high cell density , DMOS trench technology.

This high density process is especially tailored to minimize on-state resistance.

These devices are particularly suited for low voltage application such as cellular phone and notebook computer power management and other battery powered circuits, and low in-line power loss are needed in a very small outline surface mount package.

FEATURES

- ◆ -20V/-3.3 A, $R_{DS(ON)} = 45m\Omega @ V_{GS} = -4.5V$
- ◆ -20V/-2.8 A, $R_{DS(ON)} = 55m\Omega @ V_{GS} = -2.5V$
- ◆ -20V/-2.3 A, $R_{DS(ON)} = 65m\Omega @ V_{GS} = -1.8V$
- ◆ Super high density cell design for extremely low $R_{DS(ON)}$
- ◆ Exceptional on-resistance and maximum DC current capability
- ◆ SOT-23-3L package design

APPLICATIONS

- Power Management in Note book
- Portable Equipment
- Battery Powered System
- DC/DC Converter
- Load Switch
- DSC
- LCD Display inverter

PIN CONFIGURATION(SOT-23-3L)

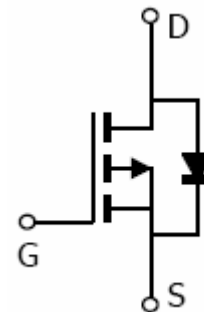
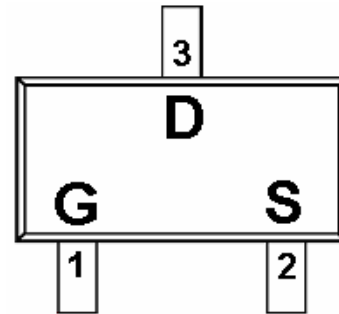

PART MARKING

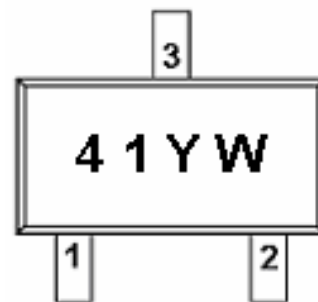

Y : Year Code
W : Week Code



SPP2341

P-Channel Enhancement Mode MOSFET

PIN DESCRIPTION

Pin	Symbol	Description
1	G	Gate
2	S	Source
3	D	Drain

ORDERING INFORMATION

Part Number	Package	Part Marking
SPP2341S23RG	SOT-23-3L	41YW

※ Week Code : A ~ Z (1 ~ 26) ; a ~ z (27 ~ 52)

※ SPP2341S23RG : Tape Reel ; Pb – Free

ABSOLUTE MAXIMUM RATINGS

(TA=25°C Unless otherwise noted)

Parameter	Symbol	Typical	Unit
Drain-Source Voltage	V _{DSS}	-20	V
Gate –Source Voltage	V _{GSS}	±12	V
Continuous Drain Current(T _J =150°C)	I _D	TA=25°C	-4.0
		TA=70°C	-2.8
Pulsed Drain Current	I _{DM}	-12	A
Continuous Source Current(Diode Conduction)	I _S	-1.0	A
Power Dissipation	P _D	TA=25°C	1.25
		TA=70°C	0.8
Operating Junction Temperature	T _J	-55/150	°C
Storage Temperature Range	T _{STG}	-55/150	°C
Thermal Resistance-Junction to Ambient	R _{θJA}	140	°C/W



SPP2341

P-Channel Enhancement Mode MOSFET

ELECTRICAL CHARACTERISTICS

(TA=25°C Unless otherwise noted)

Parameter	Symbol	Conditions	Min.	Typ	Max.	Unit
Static						
Drain-Source Breakdown Voltage	$V_{(BR)DSS}$	$V_{GS}=0V, I_D=-250\mu A$	-20			V
Gate Threshold Voltage	$V_{GS(th)}$	$V_{DS}=V_{GS}, I_D=-250\mu A$	-0.35		-0.9	
Gate Leakage Current	I_{GSS}	$V_{DS}=0V, V_{GS}=\pm 12V$			± 100	nA
Zero Gate Voltage Drain Current	I_{DSS}	$V_{DS}=-20V, V_{GS}=0V$			-1	uA
		$V_{DS}=-20V, V_{GS}=0V$ $T_J=55^\circ C$			-10	
On-State Drain Current	$I_{D(on)}$	$V_{DS} \leq -5V, V_{GS}=-4.5V$	-6			A
Drain-Source On-Resistance	$R_{DS(on)}$	$V_{GS}=-4.5V, I_D=-3.3A$		0.036	0.045	Ω
		$V_{GS}=-2.5V, I_D=-2.8A$		0.045	0.055	
		$V_{GS}=-1.8V, I_D=-2.3A$		0.055	0.065	
Forward Transconductance	g_{fs}	$V_{DS}=-5.0V, I_D=-3.3A$		3		S
Diode Forward Voltage	V_{SD}	$I_S=-1.6A, V_{GS}=0V$		-0.8	-1.2	V
Dynamic						
Total Gate Charge	Q_g	$V_{DS}=-6V, V_{GS}=-4.5V$ $I_D=-3.3A$		8	13	nC
Gate-Source Charge	Q_{gs}			1.2		
Gate-Drain Charge	Q_{gd}			2.2		
Input Capacitance	C_{iss}	$V_{DS}=-6V, V_{GS}=0V$ $f=1MHz$		700		pF
Output Capacitance	C_{oss}			160		
Reverse Transfer Capacitance	C_{rss}			120		
Turn-On Time	$t_{d(on)}$	$V_{DD}=-6V, R_L=6\Omega$ $I_D=-1.0A, V_{GEN}=-4.5V$ $R_G=6\Omega$		15	25	ns
	t_r			35	55	
Turn-Off Time	$t_{d(off)}$			60	90	
	t_f			40	60	



SPP2341 P-Channel Enhancement Mode MOSFET

TYPICAL CHARACTERISTICS

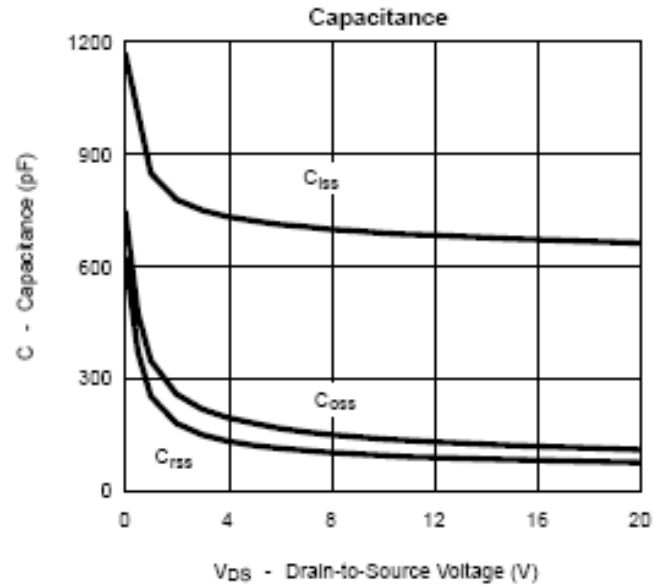
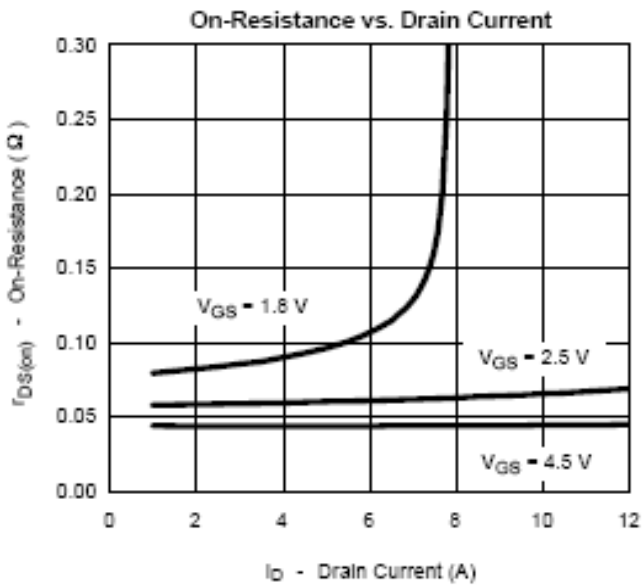
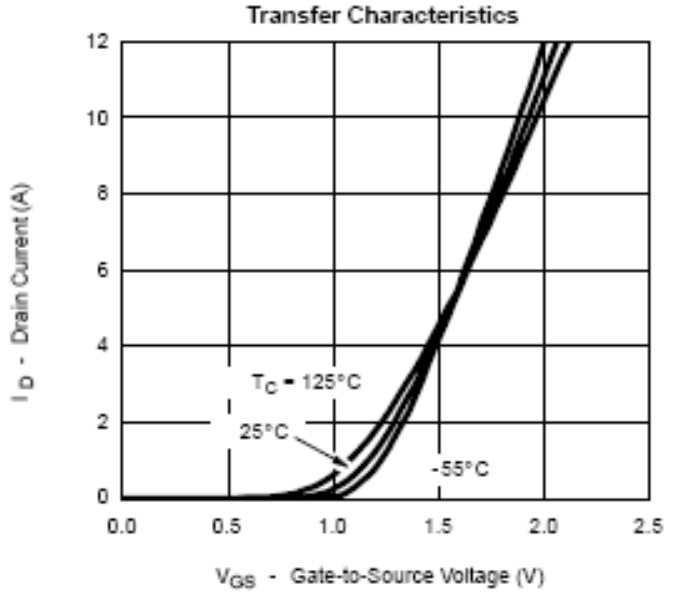
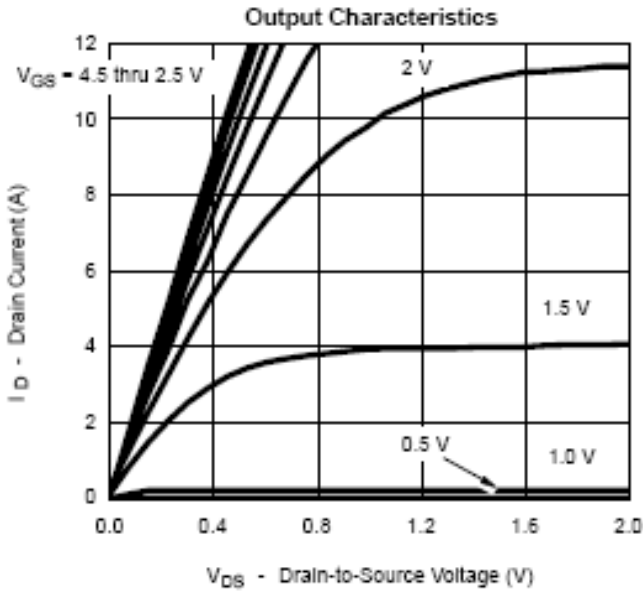



SPP2341 P-Channel Enhancement Mode MOSFET

TYPICAL CHARACTERISTICS

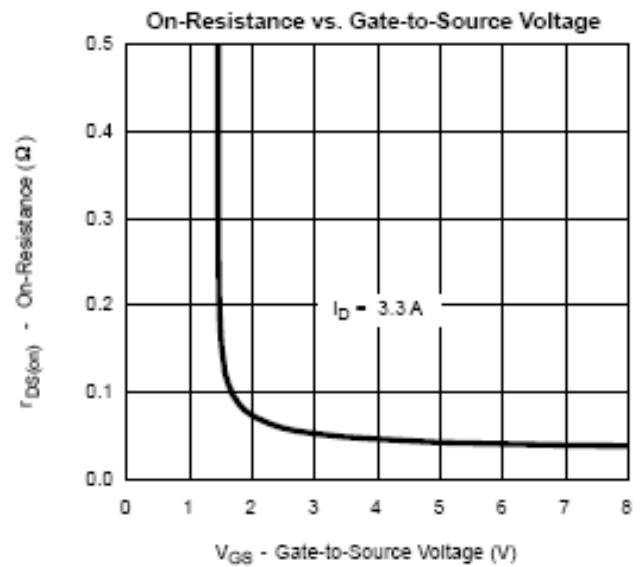
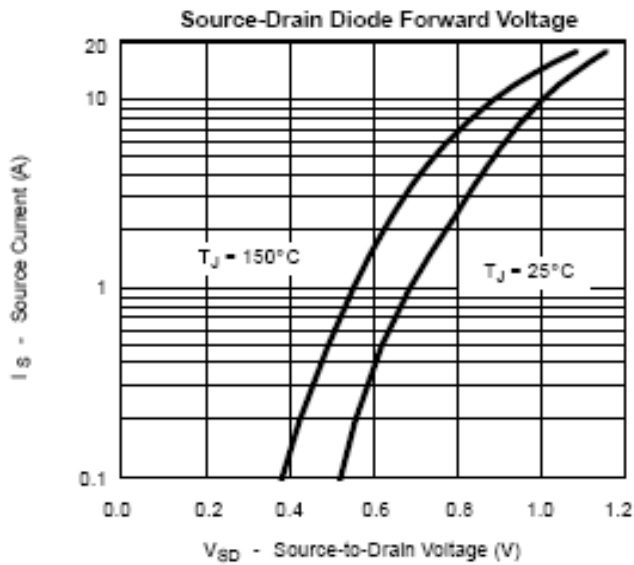
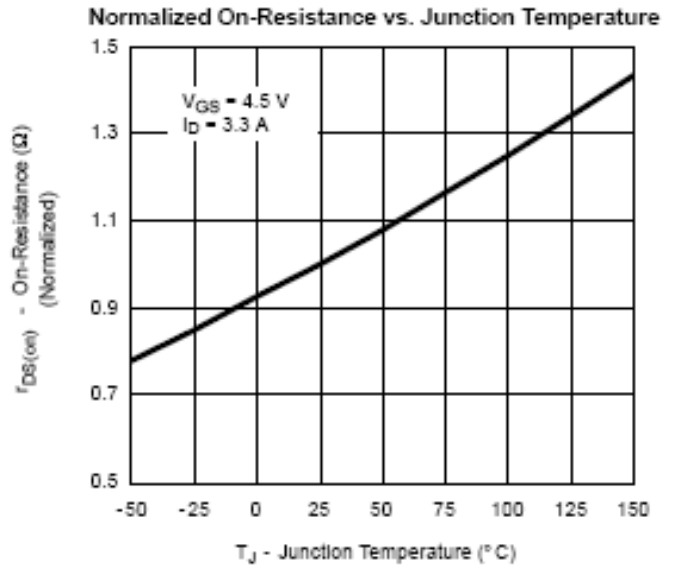
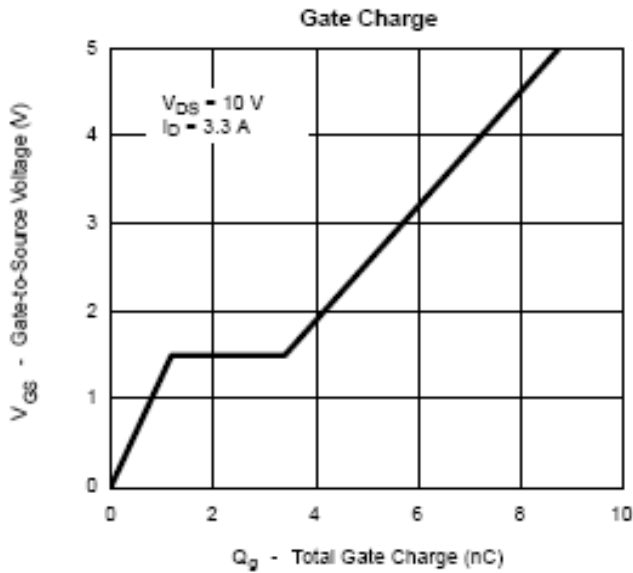



SPP2341 P-Channel Enhancement Mode MOSFET

TYPICAL CHARACTERISTICS

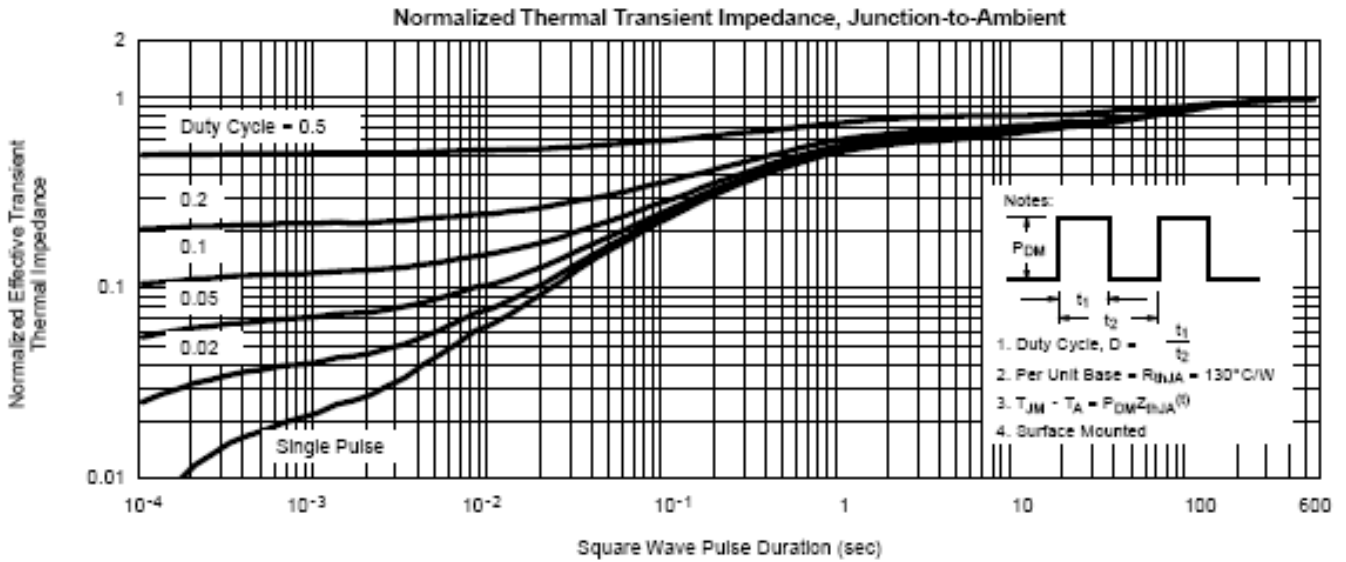
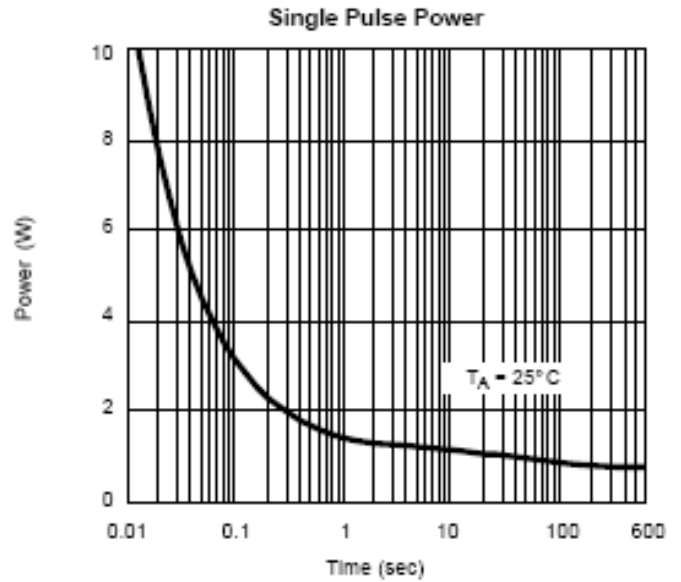
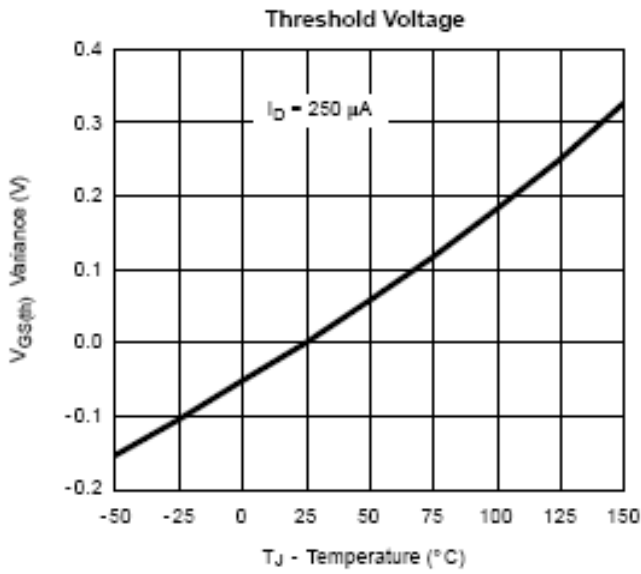



SPP2341

P-Channel Enhancement Mode MOSFET

SOT-23-3L PACKAGE OUTLINE

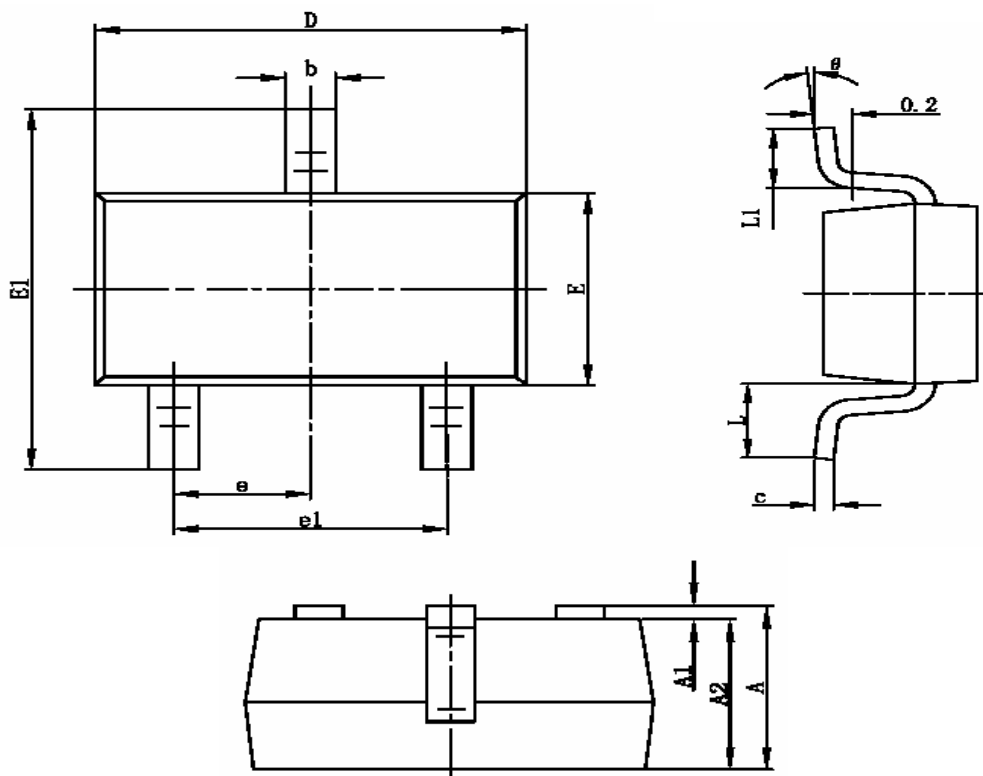

Symbol	Dimensions In Millimeters		Dimensions In Inches	
	Min	Max	Min	Max
A	1.050	1.250	0.041	0.049
A1	0.000	0.100	0.000	0.004
A2	1.050	1.150	0.041	0.045
b	0.300	0.400	0.012	0.016
c	0.100	0.200	0.004	0.008
D	2.820	3.020	0.111	0.119
E	1.500	1.700	0.059	0.067
E1	2.650	2.950	0.104	0.116
e	0.950TYP		0.037TYP	
e1	1.800	2.000	0.071	0.079
L	0.700REF		0.028REF	
L1	0.300	0.600	0.012	0.024
θ	0°	8°	0°	8°



SPP2341

P-Channel Enhancement Mode MOSFET

Information provided is alleged to be exact and consistent. SYNC Power Corporation presumes no responsibility for the penalties of use of such information or for any violation of patents or other rights of third parties which may result from its use. No license is granted by allegation or otherwise under any patent or patent rights of SYNC Power Corporation. Conditions mentioned in this publication are subject to change without notice. This publication surpasses and replaces all information previously supplied. SYNC Power Corporation products are not authorized for use as critical components in life support devices or systems without express written approval of SYNC Power Corporation.

©The SYNC Power logo is a registered trademark of SYNC Power Corporation

©2004 SYNC Power Corporation – Printed in Taiwan – All Rights Reserved

SYNC Power Corporation

9F-5, No.3-2, Park Street

NanKang District (NKSP), Taipei, Taiwan 115

Phone: 886-2-2655-8178

Fax: 886-2-2655-8468

©<http://www.syncpower.com>