

# International IOR Rectifier

15ETL06  
15ETL06S  
15ETL06-1  
15ETL06FP

## Ultra-low $V_F$ Hyperfast Rectifier for Discontinuous Mode PFC

### Features

- Benchmark Ultra-low Forward Voltage Drop
- Hyperfast Recovery Time
- Low Leakage Current
- 175°C Operating Junction Temperature
- Fully Isolated package ( $V_{INS} = 2500 V_{RMS}$ )
- UL E78996 approved 

$V_F = 0.99V$  typ.  
 $I_{F(AV)} = 15Amp$   
 $V_R = 600V$

### Description

State of the art, ultra-low  $V_F$ , soft-switching Hyperfast Rectifiers optimized for Discontinuous (Critical) Mode (DCM) Power Factor Correction (PFC).

The minimised conduction loss, optimized stored charge and low recovery current minimize the switching losses and reduce over dissipation in the switching element and snubbers.

The device is also intended for use as a free wheeling diode in power supplies and other power switching applications.

### Applications



AC-DC SMPS 70W-400W

e.g. Laptop & Printer AC Adaptors, Desktop PC, TV & Monitor, Games units and DVD AC-DC power supplies.

### Absolute Maximum Ratings

Parameters	Max	Units
$V_{RRM}$ Peak Repetitive Reverse Voltage	600	V
$I_{F(AV)}$ Average Rectified Forward Current @ $T_C = 154^\circ C$ @ $T_C = 120^\circ C$ (FULLPACK)	15	A
$I_{FSM}$ Non Repetitive Peak Surge Current @ $T_J = 25^\circ C$	250	
$I_{FM}$ Peak Repetitive Forward Current	30	
$T_J, T_{STG}$ Operating Junction and Storage Temperatures	- 65 to 175	$^\circ C$

### Case Styles

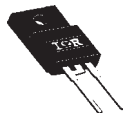
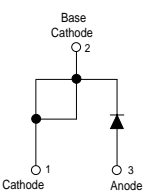
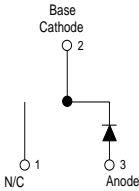
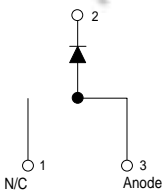
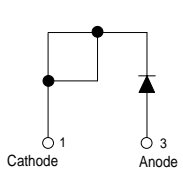
15ETL06	15ETL06S	15ETL06-1	15ETL06FP
			
			
TO-220AC	D <sup>2</sup> PAK	TO-262	TO-220 FULLPACK

**Electrical Characteristics @  $T_J = 25^\circ\text{C}$  (unless otherwise specified)**

Parameters	Min	Typ	Max	Units	Test Conditions
$V_{BR}, V_r$ Breakdown Voltage, Blocking Voltage	600	-	-	V	$I_R = 100\mu\text{A}$
$V_F$ Forward Voltage	-	0.99	1.05	V	$I_F = 15\text{A}, T_J = 25^\circ\text{C}$
	-	0.85	0.92	V	$I_F = 15\text{A}, T_J = 150^\circ\text{C}$
$I_R$ Reverse Leakage Current	-	0.1	10	$\mu\text{A}$	$V_R = V_R$ Rated
	-	15	120	$\mu\text{A}$	$T_J = 150^\circ\text{C}, V_R = V_R$ Rated
$C_T$ Junction Capacitance	-	20	-	pF	$V_R = 600\text{V}$
$L_S$ Series Inductance	-	8.0	-	nH	Measured lead to lead 5mm from package body

**Dynamic Recovery Characteristics @  $T_C = 25^\circ\text{C}$  (unless otherwise specified)**

Parameters	Min	Typ	Max	Units	Test Conditions
$t_{rr}$ Reverse Recovery Time	-	60	120	ns	$I_F = 1\text{A}, di_F/dt = 100\text{A}/\mu\text{s}, V_R = 30\text{V}$
	-	190	270		$I_F = 15\text{A}, di_F/dt = 100\text{A}/\mu\text{s}, V_R = 30\text{V}$
	-	220	-		$T_J = 25^\circ\text{C}$
	-	320	-		$T_J = 125^\circ\text{C}$
$I_{RRM}$ Peak Recovery Current	-	19	-	A	$T_J = 25^\circ\text{C}$
	-	26	-		$T_J = 125^\circ\text{C}$
$Q_{rr}$ Reverse Recovery Charge	-	2.2	-	$\mu\text{C}$	$T_J = 25^\circ\text{C}$
	-	4.3	-		$T_J = 125^\circ\text{C}$

$I_F = 15\text{A}$   
 $di_F/dt = 200\text{A}/\mu\text{s}$   
 $V_R = 390\text{V}$

**Thermal - Mechanical Characteristics**

Parameters	Min	Typ	Max	Units
$T_J$ Max. Junction Temperature Range	-	-	175	$^\circ\text{C}$
$T_{Stg}$ Max. Storage Temperature Range	- 65	-	175	
$R_{thJC}$ Thermal Resistance, Junction to Case	-	Per Leg	1.0	1.3
		Fullpack (Per Leg)	3.0	
$R_{thJA}$ ① Thermal Resistance, Junction to Ambient	-	-	70	$^\circ\text{C}/\text{W}$
$R_{thCS}$ ② Thermal Resistance, Case to Heatsink	-	0.5	-	
Weight	-	2.0	-	g
	-	0.07	-	(oz)
Mounting Torque	6.0	-	12	Kg-cm
	5.0	-	10	lbf.in

① Typical Socket Mount

② Mounting Surface, Flat, Smooth and Greased

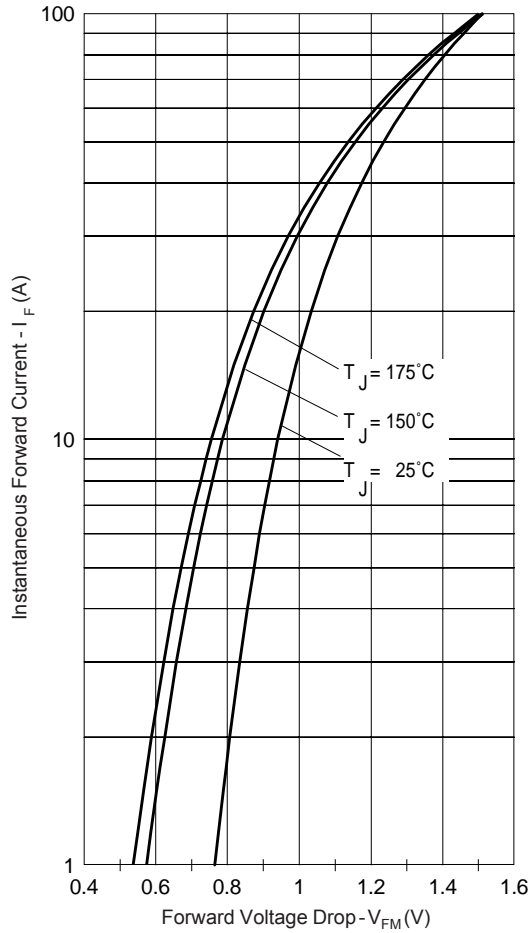

Fig. 1 - Typical Forward Voltage Drop Characteristics

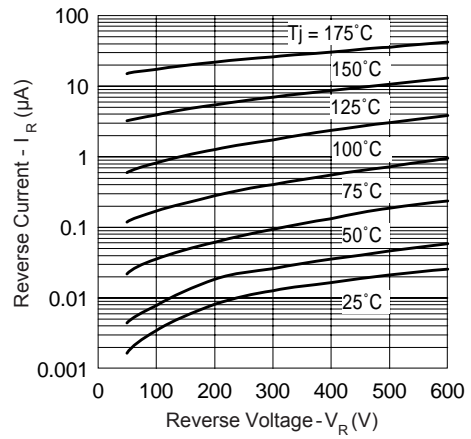

Fig. 2 - Typical Values Of Reverse Current Vs. Reverse Voltage

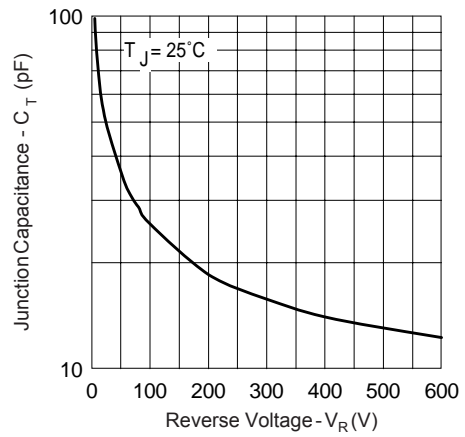

Fig. 3 - Typical Junction Capacitance Vs. Reverse Voltage

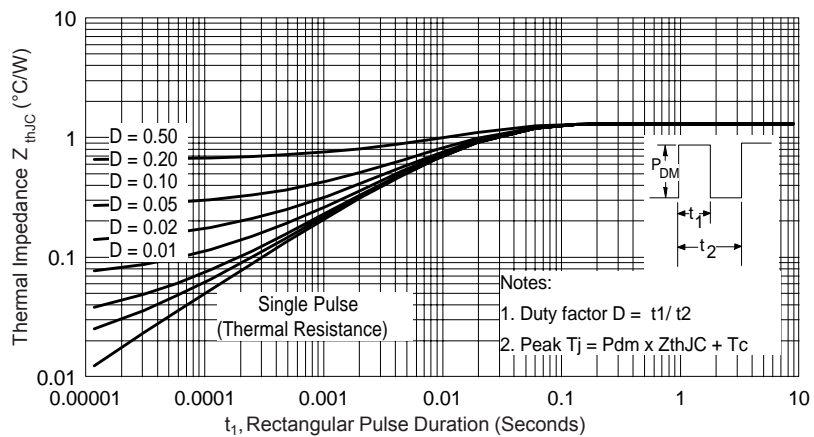

Fig. 4 - Max. Thermal Impedance  $Z_{thJC}$  Characteristics

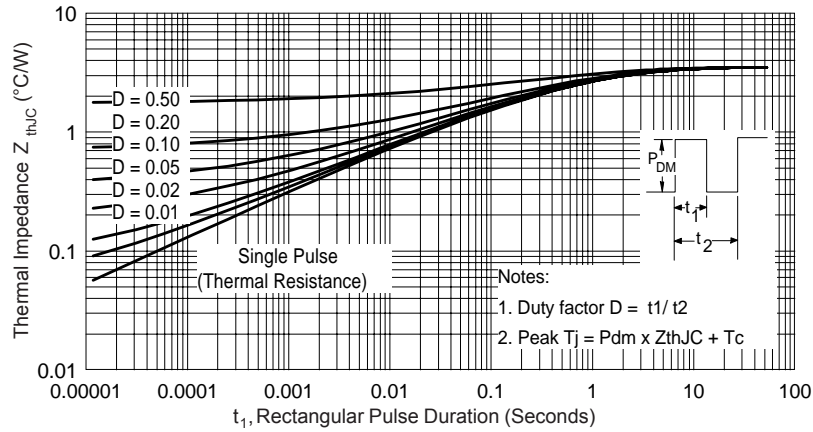

Fig. 5 - Max. Thermal Impedance  $Z_{thJC}$  Characteristics (FULLPACK)

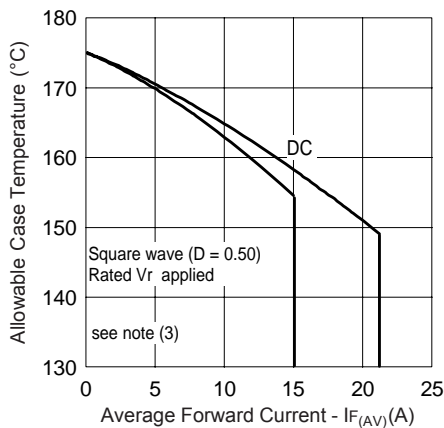

Fig. 6 - Max. Allowable Case Temperature Vs. Average Forward Current

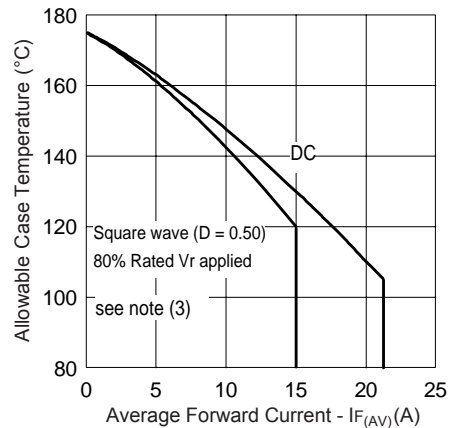

Fig. 7 - Max. Allowable Case Temperature Vs. Average Forward Current (FULLPACK)

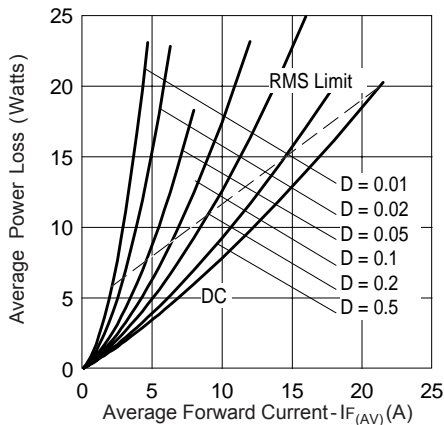

Fig. 8 - Forward Power Loss Characteristics

(3) Formula used:  $T_c = T_j - (P_d + P_{d_{REV}}) \times R_{thJC}$   
 $P_d = \text{Forward Power Loss} = I_{F(AV)} \times V_{FM} @ (I_{F(AV)} / D)$   
 (see Fig. 8);  
 $P_{d_{REV}} = \text{Inverse Power Loss} = V_{R1} \times I_R (1 - D)$   
 $I_R @ V_{R1} = \text{rated } V_R$

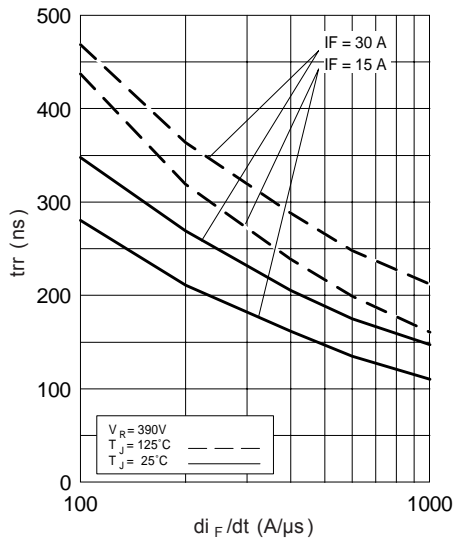

Fig. 9 - Typical Reverse Recovery vs.  $di_F/dt$

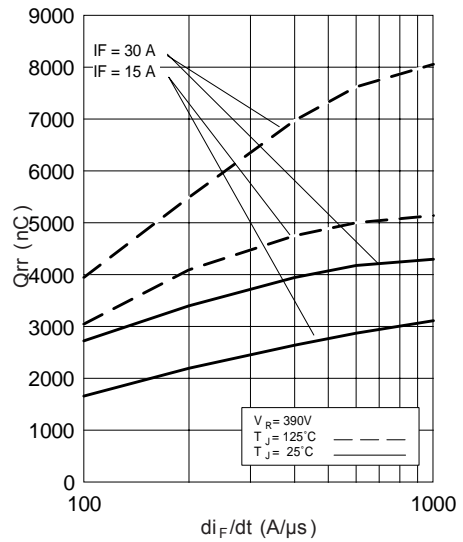

Fig. 10 - Typical Stored Charge vs.  $di_F/dt$

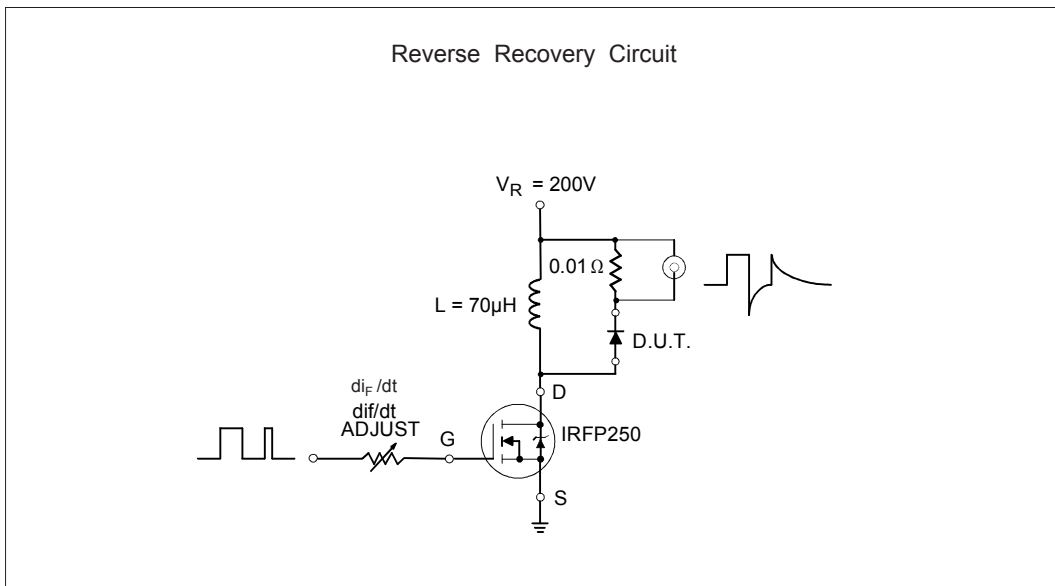

Fig. 11 - Reverse Recovery Parameter Test Circuit

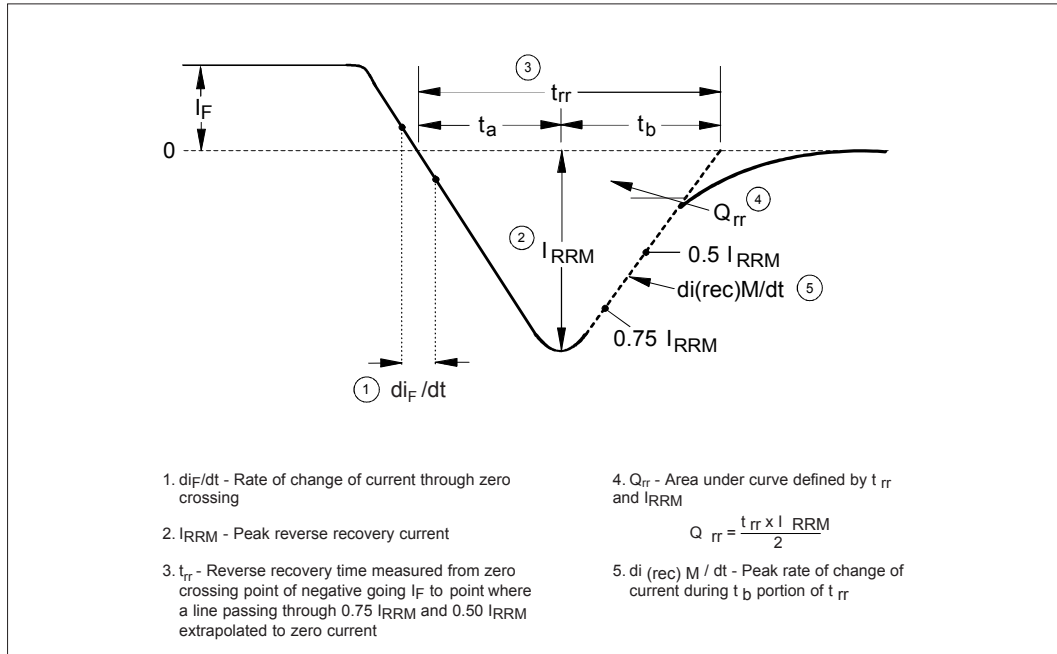
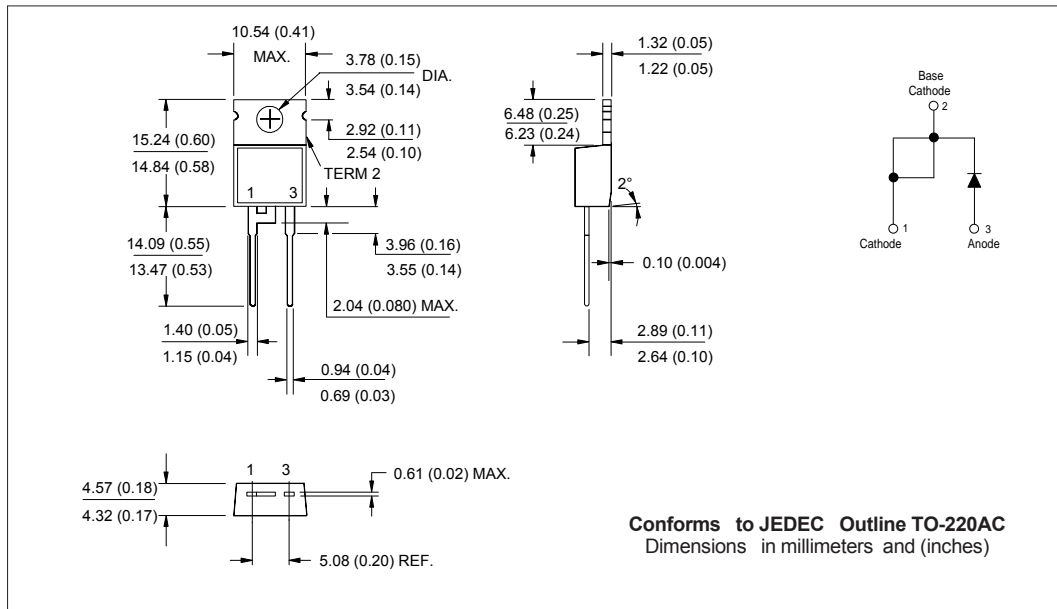
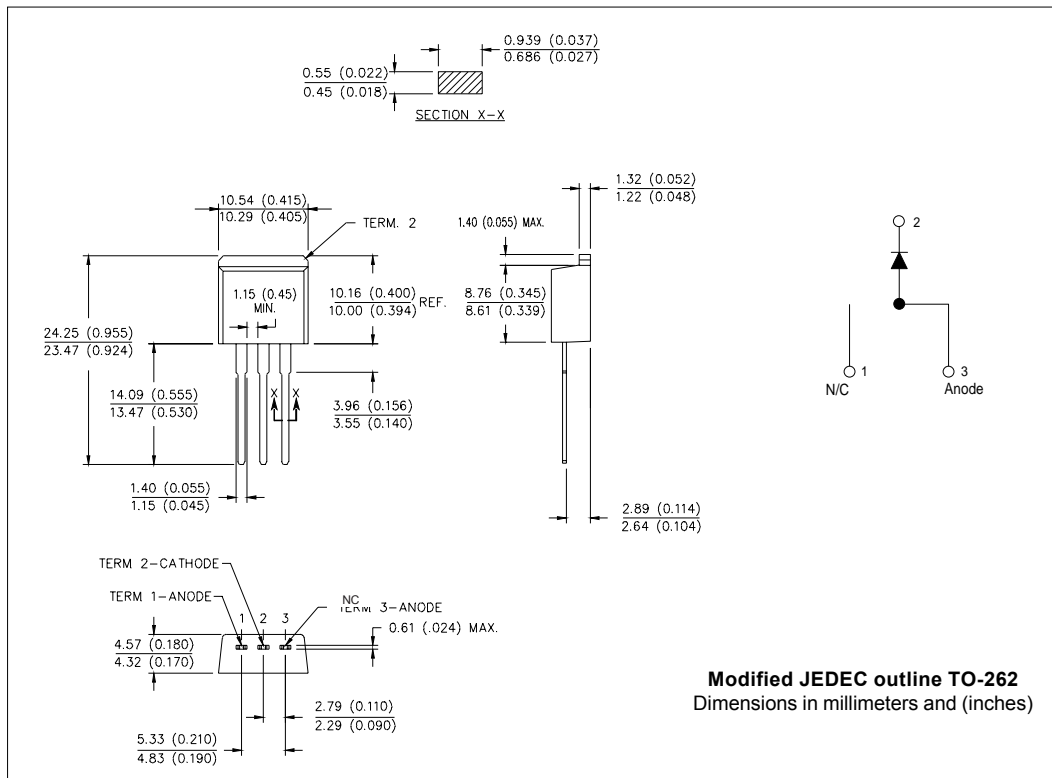
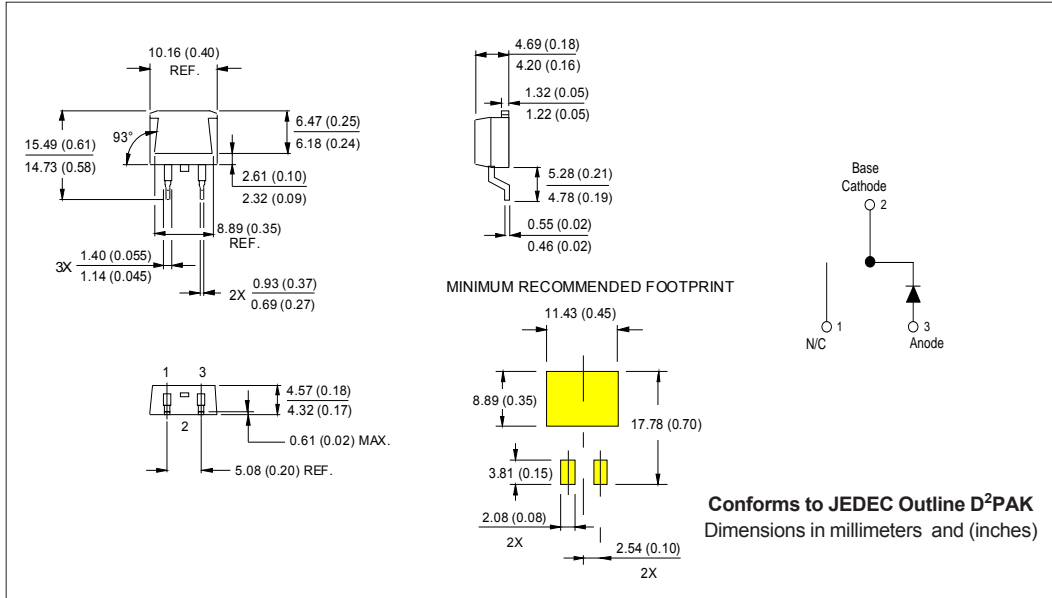

Fig. 12 - Reverse Recovery Waveform and Definitions

Outline Table



Outline Table



Outline Table

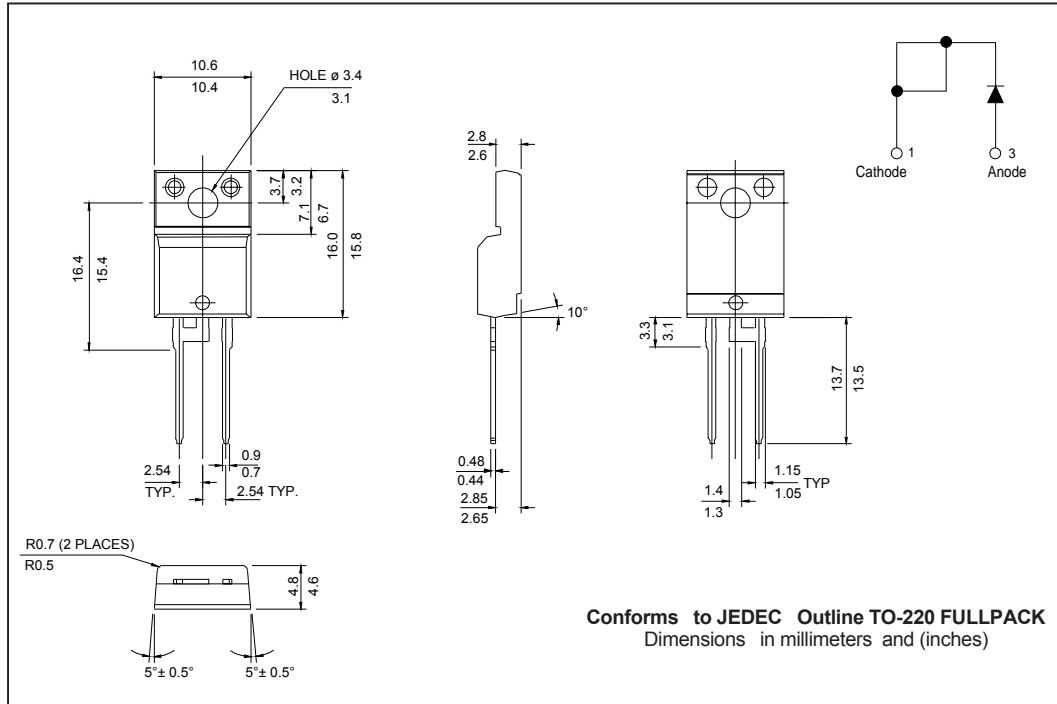

Ordering Information Table

Device Code					
15	E	T	L	06	- 1
①	②	③	④	⑤	⑥
1	- Current Rating (15 = 15A)				
2	- E = Single Diode				
3	- T = TO-220, D <sup>2</sup> Pak				
4	- L = Ultra-low V <sub>F</sub> HyperFast Recovery				
5	- Voltage Rating (06 = 600V)				
6	- "-1" = TO-262 Option				
	S = D <sup>2</sup> Pak				
	None = TO-220AC				
	FP = TO-220 FULLPACK				



Data and specifications subject to change without notice.  
This product has been designed and qualified for Industrial Level.  
Qualification Standards can be found on IR's Web site.

International  
**IOR** Rectifier

**IR WORLD HEADQUARTERS:** 233 Kansas St., El Segundo, California 90245, USA Tel: (310) 252-7105  
TAC Fax: (310) 252-7309  
Visit us at [www.irf.com](http://www.irf.com) for sales contact information. 02/04