

## APPLICATIONS

- ✓ Cellular Phones
- ✓ SMART Cards
- ✓ Notebooks
- ✓ Personal Digital Assistant (PDA)
- ✓ Ground Positioning System (GPS)

## IEC COMPATIBILITY (EN61000-4)

- ✓ 61000-4-2 (ESD): Air - 15kV, Contact - 8kV
- ✓ 61000-4-4 (EFT): 40A - 5/50ns

## FEATURES

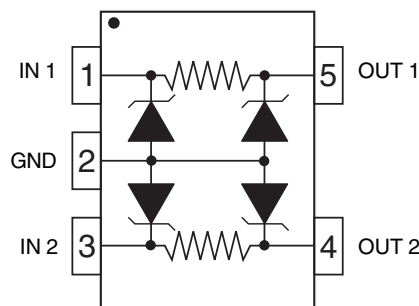
- ✓ ESD Protection > 25 kilovolts
- ✓ 18 Watts Peak Pulse Power per Line ( $t_p = 8/20\mu s$ )
- ✓ Bidirectional EMI Filtering/TVS Low Pass Filters
- ✓ Low Insertion Loss: -3db Roll-Off @ 200MHz
- ✓ Protects Up to Two (2) Data Lines

## MECHANICAL CHARACTERISTICS

- ✓ Molded JEDEC SC-70-5L
- ✓ Weight 0.1 grams (Approximate)
- ✓ Flammability rating UL 94V-0
- ✓ 8mm Tape and Reel Per EIA Standard 481
- ✓ Marking: Marking Code & Pin One Defined By Dot on Top of Package



## PIN CONFIGURATION



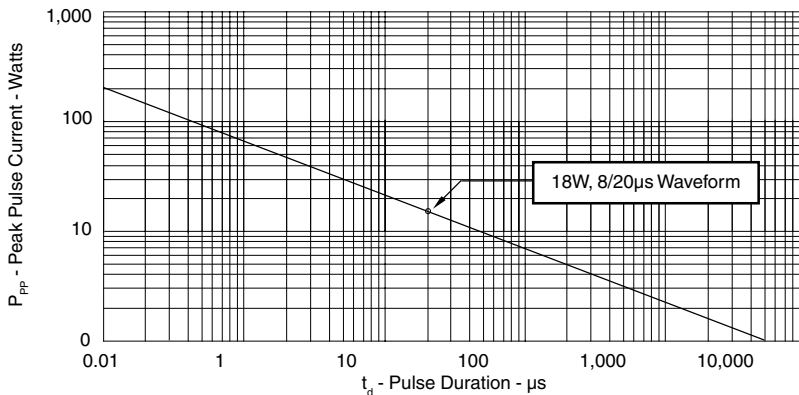
## DEVICE CHARACTERISTICS

MAXIMUM RATINGS @ 25°C Unless Otherwise Specified			
PARAMETER	SYMBOL	VALUE	UNITS
Peak Pulse Power ( $t_p = 8/20\mu s$ ) - See Figure 1	$P_{PP}$	18	Watts
Operating Temperature	$T_J$	-55°C to 150°C	°C
Storage Temperature	$T_{STG}$	-55°C to 150°C	°C
Typical Series Resistance per Line	R	100 to 150	Ohms

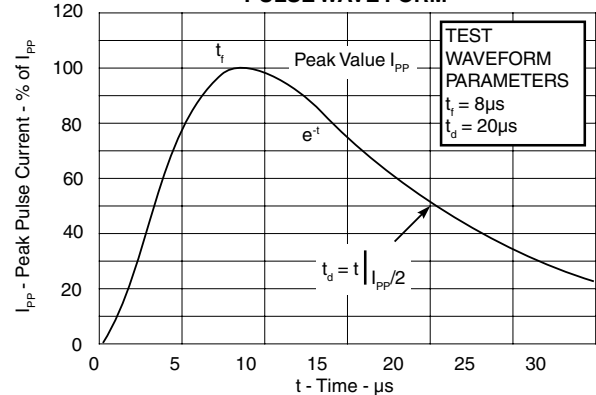
ELECTRICAL CHARACTERISTICS PER LINE @ 25°C Unless Otherwise Specified							
PART NUMBER	DEVICE MARKING	RATED STAND-OFF VOLTAGE	MINIMUM BREAKDOWN VOLTAGE	MAXIMUM REVERSE LEAKAGE CURRENT	TYPICAL FORWARD VOLTAGE	CUT-OFF FREQUENCY	MAXIMUM CAPACITANCE (See Note 1)
		$V_{WM}$ VOLTS	@ 1mA $V_{(BR)}$ VOLTS	@ $V_{WM}$ $I_D$ $\mu A$	I @ 50mA, 8/ 20 $\mu s$ $V_F$ VOLTS	MHz	@ 0V, 1 MHz C pF
EMIF01-100	E10	3.0	6.0	0.5	1.0	220	26
EMIF01-150	E15	3.0	6.0	0.5	1.0	200	26

**Note 1:** Cin between pins 1 & 2, 3 & 2, 4 & 2 and 5 & 2.

**FIGURE 1**  
PEAK PULSE POWER VS PULSETIME

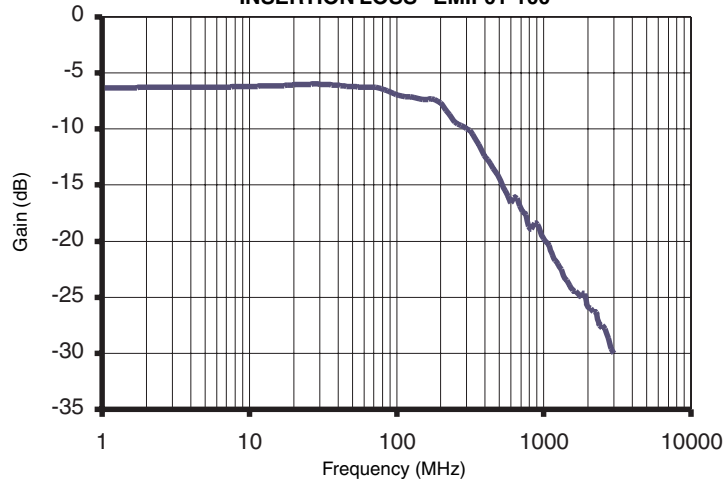


**FIGURE 2**  
PULSE WAVE FORM

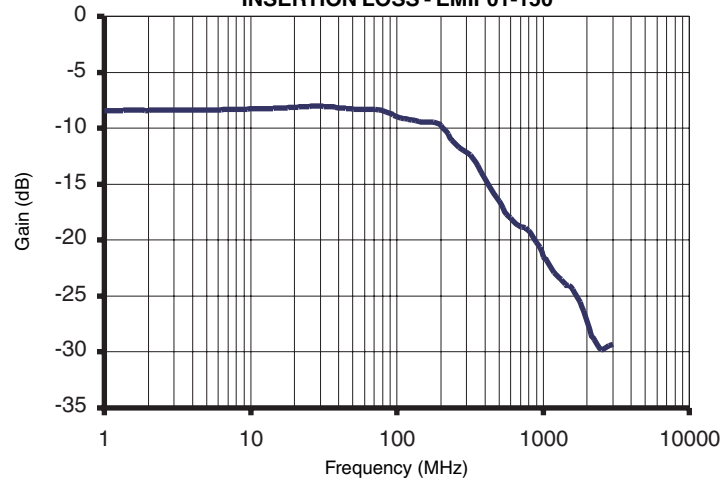


GRAPHS

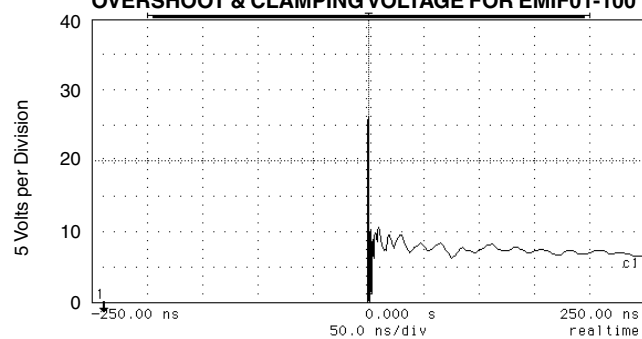
**FIGURE 3**  
**INSERTION LOSS - EMIF01-100**



**FIGURE 4**  
**INSERTION LOSS - EMIF01-150**



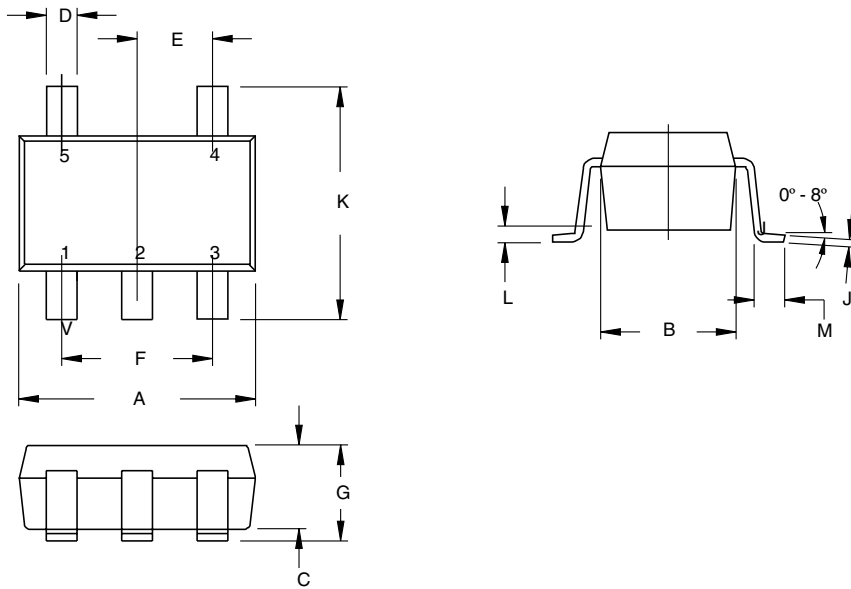
**FIGURE 5**  
**OVERSHOOT & CLAMPING VOLTAGE FOR EMIF01-100**



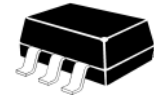
ESD Test Pulse: 25 kilovolt, 1/30ns (waveform)

## PACKAGE OUTLINE & DIMENSIONS

### PACKAGE OUTLINE



### SC -70-5L

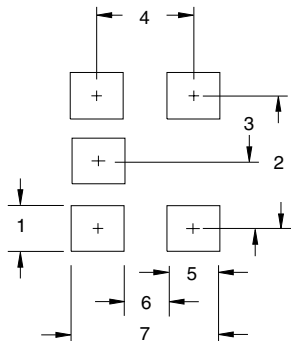


### PACKAGE DIMENSIONS

DIM	MILLIMETERS		INCHES	
	MIN	MAX	MIN	MAX
A	1.90	2.15	0.074	0.084
B	1.15	1.35	0.045	0.055
C	0.80	1.00	0.031	0.040
D	0.15	0.30	0.006	0.012
E	0.65 BSC	-	0.0255 BSC	-
F	1.30 BSC	-	0.0512 BSC	-
G	0.80	1.10	0.031	0.043
J	0.08	0.25	0.003	0.010
K	1.90	2.15	0.074	0.084
L	0	0.10	0	0.004
M	0.26	0.46	0.010	0.018

### MOUNTING PAD

TYPICAL		
DIM	Millimeters	Inches
1	0.50	0.020
2	1.30	0.051
3	0.65	0.026
4	2.40	0.094
5	0.60	0.024
6	0.70	0.028
7	2.50	0.098



### NOTES

1. Dimensioning and tolerances per ANSI Y14.5M, 1985.
2. Controlling Dimension: Inches
3. Dimensions are exclusive of mold flash and metal burrs.

### TAPE & REEL ORDERING NOMENCLATURE

1. Surface mount product is taped and reeled in accordance with EIA-481.
2. Suffix-T7 = 7 Inch Reel - 3,000 pieces per 8mm tape, i.e., EMIF01-100-T7.

Outline & Dimensions: Rev 0 - 11/01, 06005

COPYRIGHT © ProTek Devices 2003

SPECIFICATIONS: ProTek reserves the right to change the electrical and or mechanical characteristics described herein without notice (except JEDEC).

DESIGN CHANGES: ProTek reserves the right to discontinue product lines without notice, and that the final judgement concerning selection and specifications is the buyer's and that in furnishing engineering and technical assistance, ProTek assumes no responsibility with respect to the selection or specifications of such products.

### ProTek Devices

2929 South Fair Lane, Tempe, AZ 85282

Tel: 602-431-8101 Fax: 602-431-2288

E-Mail: [sales@protekdevices.com](mailto:sales@protekdevices.com)

Web Site: [www.protekdevices.com](http://www.protekdevices.com)